



This is a digital copy of a book that was preserved for generations on library shelves before it was carefully scanned by Google as part of a project to make the world's books discoverable online.

It has survived long enough for the copyright to expire and the book to enter the public domain. A public domain book is one that was never subject to copyright or whose legal copyright term has expired. Whether a book is in the public domain may vary country to country. Public domain books are our gateways to the past, representing a wealth of history, culture and knowledge that's often difficult to discover.

Marks, notations and other marginalia present in the original volume will appear in this file - a reminder of this book's long journey from the publisher to a library and finally to you.

Usage guidelines

Google is proud to partner with libraries to digitize public domain materials and make them widely accessible. Public domain books belong to the public and we are merely their custodians. Nevertheless, this work is expensive, so in order to keep providing this resource, we have taken steps to prevent abuse by commercial parties, including placing technical restrictions on automated querying.

We also ask that you:

- + *Make non-commercial use of the files* We designed Google Book Search for use by individuals, and we request that you use these files for personal, non-commercial purposes.
- + *Refrain from automated querying* Do not send automated queries of any sort to Google's system: If you are conducting research on machine translation, optical character recognition or other areas where access to a large amount of text is helpful, please contact us. We encourage the use of public domain materials for these purposes and may be able to help.
- + *Maintain attribution* The Google "watermark" you see on each file is essential for informing people about this project and helping them find additional materials through Google Book Search. Please do not remove it.
- + *Keep it legal* Whatever your use, remember that you are responsible for ensuring that what you are doing is legal. Do not assume that just because we believe a book is in the public domain for users in the United States, that the work is also in the public domain for users in other countries. Whether a book is still in copyright varies from country to country, and we can't offer guidance on whether any specific use of any specific book is allowed. Please do not assume that a book's appearance in Google Book Search means it can be used in any manner anywhere in the world. Copyright infringement liability can be quite severe.

About Google Book Search

Google's mission is to organize the world's information and to make it universally accessible and useful. Google Book Search helps readers discover the world's books while helping authors and publishers reach new audiences. You can search through the full text of this book on the web at <http://books.google.com/>

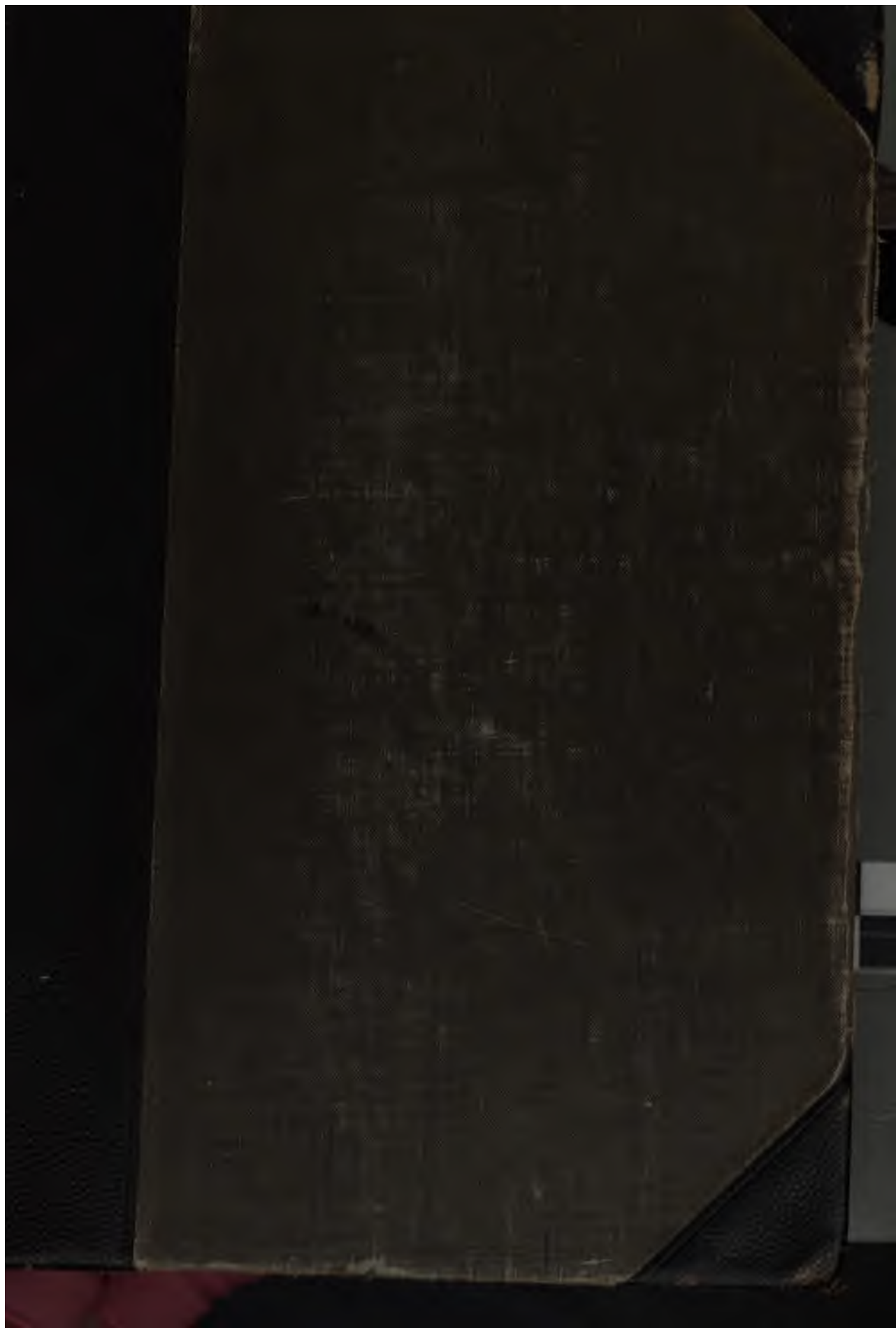



VM
145
WSY
1900

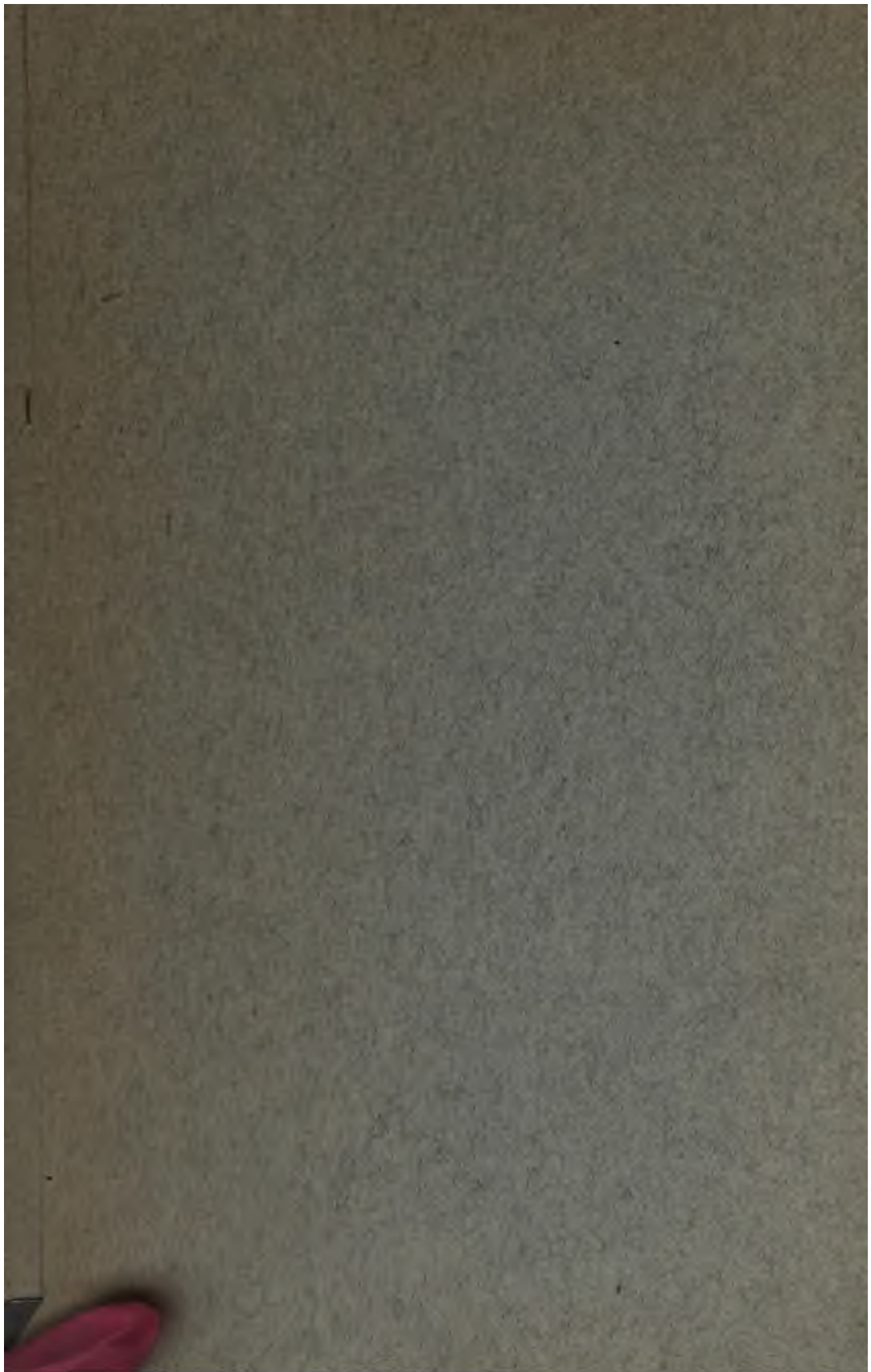

A MANUAL OF NAVAL ARCHITECTURE

FOR USE OF OFFICERS OF THE ROYAL
NAVY, OFFICERS OF THE MERCANTILE
MARINE, YACHTSMEN, SHIPOWNERS, AND
SHIPBUILDERS

BY SIR W. H. WHITE, K.C.B., Sc.D., LL.D.

ASSISTANT CONTROLLER AND DIRECTOR OF NAVAL CONSTRUCTION, ROYAL NAVY; FELLOW OF THE ROYAL SOCIETIES OF LONDON AND EDINBURGH; PRESIDENT OF THE INSTITUTION OF MECHANICAL ENGINEERS; VICE-PRESIDENT OF THE INSTITUTIONS OF CIVIL ENGINEERS AND NAVAL ARCHITECTS; PAST PRESIDENT OF THE INSTITUTE OF MARINE ENGINEERS; HONORARY MEMBER OF THE SOCIETY OF ENGINEERS, THE INSTITUTION OF ENGINEERS AND SHIPBUILDERS IN SCOTLAND, THE NORTH-EAST COAST INSTITUTION OF ENGINEERS AND SHIPBUILDERS, AND THE LIVERPOOL ENGINEERING SOCIETY; FELLOW OF THE ROYAL SCHOOL OF NAVAL ARCHITECTURE.

FIFTH EDITION

The Lords Commissioners of the Admiralty have been pleased to authorize the issue of this book to the Ships of the Royal Navy

LONDON
JOHN MURRAY, ALBEMARLE STREET
1900

P R E F A C E.

THE first edition of this book, published in 1877, grew out of lectures delivered at the Royal Naval College to naval officers and others studying there. In these lectures it was my endeavour to popularize and explain some of the many problems of naval architecture in a manner which should be intelligible to those who were interested in or connected with shipping, but not engaged as naval architects or shipbuilders. Many officers who attended the lectures requested that they might be published; and from shipowners, yachtsmen, and other persons came inquiries for a book containing, in popular language, a comprehensive summary of the theory of naval architecture. Existing treatises had been written mainly for the use of those who desired to obtain an acquaintance with the subject which would fit them for the practice of ship-designing. To benefit by these treatises a considerable knowledge of mathematics was necessary. There was obviously a want in the literature of naval architecture; and, in its original form, this book was intended to supply that want, and to enable persons, outside the profession of the naval architect, to obtain a general acquaintance with the principles of the construction, propulsion, and behaviour of ships.

The book was written, therefore, in popular language; and the mathematics introduced were of the simplest character. Explanations were given of many terms and mechanical principles, which required no explanations to readers possessing a good knowledge of mathematics. The details of theoretical investigations were omitted, but the general modes of procedure were sketched, and the practical deductions fully explained and illustrated. From this point of view, the survey of the theory of naval architecture was made as complete as possible.

The principal deductions from theory respecting the buoyancy,

stability, behaviour, resistance, and propulsion of ships, were set forth at length. Practical rules were given for regulating the draught and stowage of ships, estimating their tonnage, and approximating to their stability. Writing largely for the information of seamen, it was my endeavour to awaken in their minds an intelligent interest in the observations of deep-sea waves and the behaviour of ships. Such observations, carefully made and properly recorded, are of the greatest value to future ship-designing, and, from the nature of the case, can only be made by seamen. Practical shipbuilding was not treated in any detail, but a comprehensive sketch was given of the structural arrangements in various types of ships, of the relative qualities of the principal materials used in shipbuilding, and the principles which govern the work of the shipbuilder in providing the strength necessary to resist the action of the various straining forces to which the hulls of ships are subjected during service at sea.

It was anticipated that such a book, while primarily designed for the use of naval officers—in the Royal Navy and the Mercantile Marine—shipowners, and yachtsmen, would prove useful also as an introduction for students of naval architecture to more formal and mathematical treatises, while it would serve as a book of reference for naval architects, shipbuilders, and marine engineers.

These anticipations were realized. The book has had a wide circulation in this country and abroad. The Admiralty has approved it as a text-book for officers of the Royal Navy, and it has been issued to H.M. ships. The naval authorities of Italy and Germany have similarly approved of translations of the work. It has been extensively used by the classes for whom it was originally undertaken—naval officers, shipowners, yachtsmen, and others interested in shipping. It has become a text-book for students of naval architecture, and has been welcomed by professional men engaged in the design and construction of ships and propelling machinery.

A second edition was issued in 1882, revised and enlarged. Since that time the work has been reprinted without revision. Pressure of other work prevented me from undertaking a task which became increasingly necessary as time passed and progress was made in shipbuilding. At length the demand for a new edition became imperative; and under very difficult conditions, arising out of responsible and heavy official duties, the task now completed has been carried out, occupying my scanty leisure for nearly two years.

In this edition the general arrangement previously adopted has been maintained. A large portion of the book has been rewritten, and it has been considerably increased in size. All the sections have been carefully revised and brought up to date. The notable advance made during recent years in the application of scientific methods to merchant-ship construction has made it possible to add greatly to the information given in regard to the stability, strength, and propulsion of vessels of various types. Important inquiries and legislation have taken place also since the previous edition appeared, dealing with the load-line, the tonnage, and the watertight subdivision of merchant ships. These subjects have been summarized and discussed in the following pages, and the information brought together will be of interest to many readers.

The section dealing with steamship propulsion is practically a new and much extended treatment of this important subject. An endeavour has been made to summarize and digest the most recent and valuable theoretical and experimental investigations bearing on steamship performance and the efficiency of propellers. In the chapter on sailing ships will be found a careful *résumé* of the latest investigations of the laws of wind pressure.

I venture to hope that in its new form the book will be of greater value to naval architects and shipbuilders, while it will lose nothing of its interest for other classes of readers. Much of the information contained herein has necessarily been drawn from the work of other writers. The substance of various papers of my own, previously published, has been used. I am indebted also to many friends for valuable information not previously published, especially in regard to ships of the mercantile marine. In all cases it has been my endeavour to acknowledge the sources of information, and these references may be of value to students desiring to follow up the complete treatment of subjects which are only briefly touched upon in the following pages.

To Mr. W. E. Smith, of the Constructive Staff, my thanks are due for valuable assistance in the passage of this edition through the press.

W. H. WHITE.

January, 1894.

CONTENTS.

CHAPTER I.

THE DISPLACEMENT AND BUOYANCY OF SHIPS.

	PAGE
Definitions of displacement and buoyancy	1
Useful displacement, or carrying power	2
Approximate rules for estimating displacement	3
Curves of displacement : their construction and uses	5
Curves of tons per inch immersion : their construction and uses	6
Changes in draught of water produced by the passage of ships from the sea to rivers and docks	7
Reserve of buoyancy for various types of ships	9
Rules for freeboard	10
Load-line legislation for merchant ships	12
Load-line committee, conclusions	15
Load-line for vessels with deck erections	18
Submarine and surface vessels : fundamental principles of construction	19
Foundering of ships which are "swamped." Water-logged ships	21
Foundering of ships which have bottoms penetrated	23
Principles of watertight subdivision of ships :—	
By transverse bulkheads	25
By longitudinal bulkheads	28
By decks or platforms	30
Watertight subdivision in modern war-ships	31
Cellular double bottoms	34
Wing passage bulkheads	35
Examples of foundering caused by collision	36
"Unsinkable" ships	38
Watertight subdivision in merchant ships	39
Bulkheads committee, work of	41

CHAPTER II.

THE TONNAGE OF SHIPS.

Early systems of tonnage measurements	45
Legal tonnage of coal-carrying vessels	46
Early rules for estimating tonnage	47
Builders' old measurement tonnage	47
Tonnage legislation, 1821-1853	50

	PAGE
New measurement tonnage, 1836	51
Moorsom tonnage system, 1854	52
Royal Commission of 1881	53
Tonnage deck defined by House of Lords	55
Approximate rules for gross tonnage	56
Register tonnage	59
Deductions permitted from gross tonnage	60
Danube rule	63
Tonnage Act of 1889	64
International tonnage	65
Suez Canal rule	65
Alternative systems of tonnage for merchant ships	67
Dead-weight tonnage	68
Displacement tonnage	70
Parallelopipedon tonnage	71
Freight tonnage	72
War-ship tonnage	73
Yacht-measurements : for time allowances	74
Thames rule	75
Yacht Racing Association Rule	75
Corinthian rule	76
American rules	78

CHAPTER III.

THE STATICAL STABILITY OF SHIPS.

Condition of ships floating in still water	80
" " inclined by mechanical couple	81
Stable, unstable, and indifferent equilibrium	82
Statical stability defined	83
Metacentre for transverse inclinations	83
Stiffness, crankness, and steadiness	84
Effect of metacentric height on stiffness	85
Approximate rules for positions of centre of buoyancy and metacentre	87
Metacentric diagrams : construction and uses of	89-94
Stability of cigar and submerged vessels	95
Metacentric heights : for war-ships	97
" " for merchant steam-ships	100
Inclining experiments	103
Metacentric heights for sailing ships and yachts	105
Heel produced by traversing weights	107
Stability with shifting cargoes	110
Water ballast, effect on stability	111
Oil cargoes, precautions as regards stability	111
Stability not always reduced by free water in hold	114
Central citadel ships : metacentric height when riddled	115
Effect of adding or removing weights	117
Metacentre for longitudinal inclinations	119
Estimates for change of trim	119
Stability of ships partially waterborne	124

	PAGE
Curves of stability	126
Atwood's formula	127
Effect of freeboard and beam on stability	129
Earliest curves of stability on record	131
Curves of stability for typical war-ships	132-134
" " " merchant steamers	135
" " " sailing vessels	138
" " " torpedo-boats	139
Stability of ships when launched	141
Cross-curves of stability	144
Use of Amsler's Integrator	146

CHAPTER IV.

THE OSCILLATIONS OF SHIPS IN STILL WATER.

Comparison of ship with a pendulum	147
Angular velocity, accelerating force, and moment of inertia	149
Instantaneous axis for unresisted rolling	151
Curve of flotation	152
Motion of metacentre during rolling	153
Formula for unresisted rolling	154
Changes in period produced by changes in distribution of weights	155
Isochronous rolling	157
Dynamical stability : modes of estimating	158
Moseley's formula	160
Dipping oscillations	162
Effect of fluid resistance on rolling	163
Rolling experiments in still water	164
Curves of extinction of rolling	167
Still-water periods for typical war-ships	169
Coefficients of extinction	173
Resistance to rolling mainly due to surface disturbance	176
Usefulness of bilge keels	177
Extinctive effect of "Water chambers"	183
Thornycroft's automatic steadying apparatus	185
Resistance to rolling when sides are damaged	186
Effect of gusts or squalls of wind on rigged ships in still water	187
<i>Captain</i> compared with <i>Monarch</i>	188
Cases of capsizing in smooth water by squalls	191-192

CHAPTER V.

DEEP-SEA WAVES.

Fundamental conditions of trochoidal theory	193
Construction of trochoidal profiles	194
Orbital motions of particles and advance of wave form	196
Internal structure of wave	198

	PAGE
Variations in direction and intensity of fluid pressure incidental to wave motion	201
Heaving motion on wave surface	203
Formulae for dimensions and speeds of waves	204
Observations of waves : methods of conducting	206
Summary of maximum dimensions recorded	211
Comparison of observation with theory	214
Conditions of a confused sea	217
The genesis of waves	218
Relation of force of wind to dimensions of waves	221
Prevalent waves in different regions	222
Utilization of wave power	225

CHAPTER VI.

THE OSCILLATIONS OF SHIPS AMONG WAVES.

Early theories of rolling	226
Principal features of modern theory of rolling	227
The "virtual upright"	228
The "effective wave slope"	229
The importance of ratio of period of rolling to half period of wave	231
Fundamental assumptions for mathematical investigation of unresisted rolling	233
Critical cases of rolling of ships :—	
Amongst waves of synchronizing periods	235
Variation of period of rolling due to variation in angle of swing	237
"Permanent" oscillations	238
"Phases" of oscillation	240
Examples of actual rolling	241
Practical deductions from investigation of unresisted rolling, compared with observations of the rolling of ships at sea	242
Importance of rate of rolling on strength of structure	246
Effect of changing course and speed relative to waves	247
Influence of fluid resistance upon rolling	249
Graphic integration for resisted rolling : Mr Froude's method	251
M. Bertin's investigation for resisted rolling	253
Influence of bilge keels in steadying ships	255
Influence of projecting armour and low freeboard	257
"Water-chambers" in armoured ships, extinctive effect of	257
Rolling of ships with sails set	259
Effect of heaving motion	260
" gusts and squalls of wind	262
Ranges of stability in certain classes of vessels	263
Steadying effect of sails	264
Longitudinal oscillations : pitching and 'scending	265
Influence of length on pitching	267
" distribution of weight on pitching	270
" fluid resistance on pitching	271
Effect of low ends	272
Heaving oscillations	273

CHAPTER VII.

METHODS OF OBSERVING THE ROLLING AND PITCHING MOTIONS OF SHIPS.

	PAGE
Necessity for such observations	276
Pendulum observations, and their errors	278
Spirit-levels and clinometers	281
Gyroscopic instruments and their drawbacks	283
Admiral Paris's instrument	285
M. Normand's instrument	286
Batten instruments, various arrangements of	287
Photographic apparatus	290
Description of Mr. Froude's automatic instrument	292
Towers' "Steady platform"	294
Simultaneous observations of behaviour of ships and character of waves much needed	296

CHAPTER VIII.

THE STRAINS EXPERIENCED BY SHIPS.

Necessity for careful study of subject	298
Classification of principal strains	299
Longitudinal bending moments (hogging and sagging) :—	
Due to unequal distribution of weight and buoyancy	301
Method of estimating bending moments	301
Curves of weight, buoyancy, loads and bending moments, construction and uses of, with examples for typical ships	303–312
Bending moments due to longitudinal fluid pressure	312
Extreme cases of support for ships among waves	313
Corresponding bending moments for typical ships	317
Influence of wave structure on bending moments	319
„ pitching and 'scending upon longitudinal strains	321
Bending moments of ships ashore	322
Transverse strains experienced by ships when—	
Resting on the keel only in dock or ashore	324
Afloat in still water	325
Rolling among waves	326
Strains incidental to propulsion :—	
By sails	329
By screws or paddles	330
Straining due to vibration	330
Local strains produced by—	
Concentrated load or support	332
Grounding : with special reference to iron ships	335
Loads on decks	337
Collision : with special reference to ramming	337
Propulsion	341
Dismasting of large sailing ships	343

CHAPTER IX.

THE STRUCTURAL ARRANGEMENTS AND STRENGTH OF SHIPS.

	PAGE
Gradual development of structural arrangements	345
Features common to structures of all ships	346
Ultimate effect of longitudinal bending strains	347
Construction of "equivalent girder" sections	348
Principles of the strength of beams and girders	351
Application of these principles to longitudinal strength of ships	355
Influence of form, proportions, and local requirements upon the scantlings of ships	358
Longitudinal strength contributed by—	
Upper decks of ships	363
Skins and riders of ordinary wood ships	363
Bottoms below the bilges	365
Longitudinal framing and cellular construction	369
Skins of composite ships	375
" diagonally built wood ships	376
" iron and steel ships	376
Special arrangements of shallow-draught vessels	377
Maximum longitudinal strains on war-ships	381
" " " merchant ships	383
Provision of transverse strength	385
Strength of transverse frames or ribs in wood and iron ships	386
Partial bulkheads of iron ships	386
Bracket frames in cellular double bottoms	387
Transverse framing of ironclads and swift cruisers	387
Decks, beams, and pillars as transverse strengtheners	389
Beam-knees and beam-end fastening	391
Transverse bulkheads considered as strengtheners	393

CHAPTER X.

MATERIALS FOR SHIPBUILDING : WOOD, IRON, AND STEEL.

Remarkable progress of iron and steel shipbuilding	395
Aluminium and bronzes	397
Relative strengths and weights of timber, iron, and steel	398-404
Forms of beams in common use	405
Comparison of strength between wood and iron beams	406
Relative strengths, of combinations of wood, iron, and steel	407
Scarphing of wood beams	408
Comparative weights of wood, iron, and steel ships	411
Weights of hull in wood-built ships	413
" " iron and steel ships	415
Distribution of weights in battle-ships	417
" " " a swift protected cruiser	418
Comparative durability of wood, iron, and steel ships	419
Iron and steel not subject to internal sources of decay	420

	PAGE
Preservation of iron hulls	421
Corrosion of iron and steel ships	422
Increase of corrosion due to galvanic action	424
Admiralty regulations for the preservation of iron and steel ships	427
Fouling of ships	428
Copper sheathing to prevent fouling	428
Muntz metal and naval brass	429
Zinc sheathing	430
Prevention of fouling	431
Wood-sheathed ships	432
Nickel steel as a material for bottoms	435

CHAPTER XI.

THE RESISTANCE OF SHIPS.

Early theories of resistance	436
Classification of water resistance	437
Resistance to direct and oblique motion of plates	438-440
Modern formulæ for direct resistance on front of plates	440
Recent experiments on oblique resistance	441
Froude's experiments on frictional resistance	442
Effect of length on frictional resistance	443
Stream-line theory of resistance	445
Rankine's rules for constructing stream lines	447
Motion of a perfect fluid through a bent pipe	449
"Augmented surface"	452
Eddy-making resistance	453
Characteristics of wake of ships	454
Modern experiments on stream lines at sterns of ships	455
Wave-making resistance	456
Scott Russell's rules for length of entrance and run	459
Waves accompanying ships	460
Effect of varying lengths of middle body	462
Summary of chief features of resistance	466
Effect of shoal water	466-469
Recent advance in speeds	470
Tow-rope strains in typical cases	471
Resistance of torpedo-boats at very high speeds	471
Ship-design as influenced by form and resistance	474
<i>Greyhound</i> towed by <i>Active</i>	475
Influence of Suez Canal on forms and proportions	478
Model experiments on resistance	479
Scale of comparison between models and ships	480-487
Air resistance	487
Resistance when motion is not uniform	489
Resistance in a seaway	490

CHAPTER XII.

PROPULSION BY SAILS.

	PAGE
Laws of wind pressure	491
Results of experiments on wind pressures and velocities	493
Effect of size of structure on average pressure	495
Experiments on wind pressure on Forth bridge	497
Wind pressure on oblique plates	498
Wind pressure on curved surfaces and sails	499
Classification of winds (Beaufort scale)	502
Propulsive effect of wind on sails	503
Actual and apparent direction and velocity of wind relatively to sails	504
Leeway	506
Speeds of ice yachts	509
Ardency and slackness	509
Case of ship sailing close hauled	510
French experiments on <i>Jean Bart</i>	511
Preparation of sail plans	512
Plain sail for various rigs	513
Ratio of sail area to area of immersed surface	515
Sail spread in terms of (displacement) ²	517
Sail areas of yachts	519
Distribution of sail	520
Positions of masts and length of base of sail	523
Sail spread on each mast	525
Vertical distribution of sail	526
Angle of heel under sail	527
Sail-carrying power	529
Dimensions and proportions of modern sailing ships	530
Propulsion under steam and sail	532
Proportions of yachts	533

CHAPTER XIII.

STEAM PROPULSION—MEASURES OF HORSE-POWER, AND PROPULSIVE COEFFICIENTS.

General problem	534
Joint responsibility of naval architect and marine engineer	534
Tentative character of first stages of design	535
Effective horse-power	536
Indicated horse-power	537
Duration of steam trials in various vessels	538
French horse-power	539
Nominal „	539
Normal „	541
Lloyds' rule	541
Propulsive coefficients	542
Efficiency of mechanism	543
Constant friction	544

	PAGE
Early use of twin screws	575
Use of twin screws in mercantile marine	576
Single screws not more efficient than twin screws	577
Use of two screws on one shaft	578
Triple and multiple screws	579
Triple screws with respect to economy of coal at low speeds	580
Screw turbine propeller	581
Fundamental principles of action of propeller, thrust and efficiency	582
Water-jet propeller	587
<i>Waterwitch</i> trials	590
Jet-propelled torpedo-boats	591
<i>Hydromotor</i> trials	593
Paddle-wheels, general principles	594
" " practical rules for design	598

CHAPTER XVI.

THE SCREW PROPELLER.

General definitions	599
Efficiency diagram	601
Effect of wake on screw propulsion	603
Thrust horse-power	604
Sufficient immersion necessary for efficiency	605
Theories relating to screw propulsion	605
Professor Rankine's investigations	606
" Greenhill's	607
Mr. W. Froude's	608
Mr. Calvert's	610
Professor Cotterill's	610
" Maurice Fitzgerald's and Mr. R. E. Froude's investigations	611
Determination of dimensions for screw propeller	611
Sea trials	612
Progressive trials	613
Special experimental trials on <i>Iris</i>	615
Experiments with model screws	616
Mr. Thornycroft's trials	618
Messrs. R. and W. Hawthorn's trials	619
Mr. Blechynden's deductions	622
General conclusions	624

CHAPTER XVII.

ESTIMATES FOR THE HORSE-POWER AND SPEED OF STEAMSHIPS—STEAMSHIP EFFICIENCY.

"Admiralty" coefficients	625
Ordinary calculations for I.H.P.	627
Rankine's "augmented surface" method	629
Early progressive steam trials	630

	PAGE
Variation of I.H.P. with size of ship	633
I.H.P. of <i>Hercules</i> based on that of <i>Greyhound</i>	635
Steamship efficiency	637
Economical propulsion favoured by increase in size	638
Examples of economy of propulsion	640
Economy of propulsion as affected by suitable form and proportions ...	641
<i>Hercules</i> compared with longer ship	643
Central citadel ships and circular ironclads	644
<i>Devastation</i> compared with circular ironclad	645
Speed of <i>Livadia</i>	646
Recent developments of speed	649
Speed and I.H.P. for typical ships	649

CHAPTER XVIII.

THE STEERING OF SHIPS.

Various modes of steering	651
Most advantageous position for rudder	651
Ordinary and balanced rudders	652
"Turn-about" system	654
Fluid pressure on rudders: causes and measures of	655
Relative effects of upper and lower portions of rudders	657
Special features of screw-ship steerage	657
British Association Committee's experiments	659
Length required for stopping ships	660
Effect of reversing engines on steering	661
Force required on tillers	663
Joëssel's rudder	665
Calculations for strengths of rudder heads and steering gear	666
Mechanical work done in putting rudders over	667
Balanced rudders: their advantages	668
Steam and hydraulic steering gear	669
Turning effect of rudders	670
Causes affecting readiness to answer helm	672
Steerage in shallow water	674
Paths traversed by ships in turning	675
French experiments	676
Turning trials of <i>Thunderer</i>	677
Drift angles for ships turning, and their effects	680
Heeling of ships in turning	684
Deductions from turning trials of ships	687-693
Determination of rudder areas	693
Forms of rudder	697
Special rudders	698
Auxiliary appliances for steering	699
Bow rudders	700
Torpedo-gunboat turning trials with typical forms of rudders	701
Thornycroft's steering paddle	703

	PAGE
<i>Comus</i> class auxiliary rudders	704
Steering by propellers	705
Mallory propeller	707
Fowler's propeller	708
Erratic steering of <i>Ajax</i> , and how remedied	709
General conclusions for twin-screw ships	710
Special case of <i>Faraday</i> telegraph ship	712
<i>Waterwitch</i> steering trials	713
Manœuvring in a seaway	714
<hr/>	
INDEX	715

NAVAL ARCHITECTURE.

CHAPTER I.

THE DISPLACEMENT AND BUOYANCY OF SHIPS.

9 A SHIP floating freely and at rest in still water must displace a volume of water having a weight equal to her own weight. The truth of this fundamental condition may be easily demonstrated. Let Fig. 1 represent the ship (in profile view and athwartship section), WL being the surface of the water. If it is supposed that the water surrounding the ship becomes solidified, and that the ship is then removed, there will remain a cavity representing in form and volume the water displaced by the ship: this is termed the "volume of displacement" (or, shortly, the "displacement") of the ship, being represented in the diagrams by WKL. If the cavity is then filled up to the level of the surface WL with water of the same density

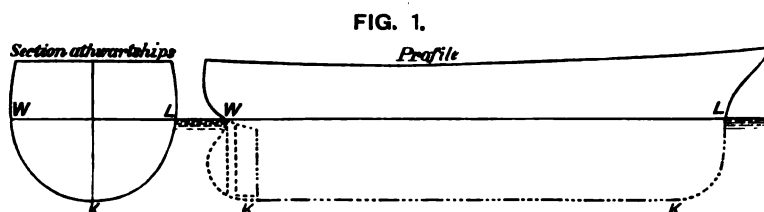

as that in which the ship floated, and afterwards the surrounding water again becomes liquid, there will obviously be no disturbance or change of level in consequence of the substitution of the water for the ship. Therefore the total weight of water poured into the cavity—that is, the total weight of water displaced by the ship—must equal her weight.

This fundamental law of hydrostatics applies to all floating bodies, and is equally true of wholly submerged vessels floating at any depth as of ships of ordinary form, having only a portion of their volume immersed.

Ships which are of equal weight may differ greatly in form and

dimensions, and consequently the forms of their respective displacements will differ; but when they are floating in water of the same density, the volumes must be equal to one another, because the weights of the ships are equal. On the other hand, when a ship passes from water of one density to water of another density, say from the open sea to a river where the water is comparatively fresh, her volume of displacement must change, because the weight of water displaced must be the same in both cases. Under all circumstances the volume of displacement, multiplied by the weight per unit of volume of the water in which the ship floats, must equal the weight of the ship. It is usual to express the volume in cubic feet, and for sea-water to take 64 lbs. as the weight of a cubic foot; so that the weight of the ship in tons multiplied by thirty-five gives the number of cubic feet in the volume of displacement when she floats in sea-water.

At every point on the bottom of a ship floating freely and at rest in still water, the water pressure acts perpendicularly to the bottom. This normal pressure at any point is proportional to the depth of the point below the water surface; and it may be regarded as made up of three component pressures. First, a vertical pressure; second, a horizontal pressure acting athwartships; third, a horizontal pressure acting longitudinally. Over the whole surface of the bottom a similar decomposition of the normal fluid pressures may be made; but of the three sets of forces so obtained, only those acting vertically are important in a ship at rest. The horizontal components in each set must obviously be exactly balanced amongst themselves, otherwise the ship would be set in motion either athwartships or lengthwise. The sum of the vertical components must be balanced by the weight of the ship, which is the only other vertical force; this sum is usually termed the "buoyancy;" it equals the weight of water displaced, and the two terms "buoyancy" and "displacement" are often used interchangeably.

The total weight of a ship may be subdivided into the "weight of the hull," or structure, and the "weight of lading." The latter measures the "carrying power" of the ship, and is therefore frequently termed the "useful displacement." Useful displacement for a certain degree of immersion is simply the difference between the total displacement and the weight of the hull; so that any decrease in the weight of hull leads to an increase in the carrying power. If the ship is a merchantman, savings on the hull enable the owner either to carry more cargo in a vessel of a specified size or else to build a smaller vessel to carry a specified cargo. If the ship is a man-of-war, such savings on the hull render possible increase in the offensive or defensive powers, or in the coal supply, engine power,

or speed; or else enable certain specified qualities to be obtained on smaller dimensions than would otherwise be practicable. Hence appears the necessity for careful selection of the best materials and most perfect structural arrangements, in order that the necessary strength may be secured in association with the minimum of weight. It is in this direction that all recent improvements in shipbuilding have tended; the use of iron hulls instead of wood greatly facilitated progress, and further advances are now being made by the substitution of steel for iron. These improvements in ship-construction are described in Chapter X.

Having given the draught of water to which it is proposed to immerse a ship, the volume of her immersed part determines the corresponding displacement, and this displacement can be calculated with exactitude from the drawings of the ship. This is the method adopted by the naval architect; but any details of the method would be out of place here. At the same time an approximate rule by which an estimate of the displacement of the ship may be rapidly made may have some value. Assuming that the length of the ship at the load-line is known (say L), also the breadth extreme (B), and the mean draught (D), the product of these three dimensions will give the volume of a parallelepipedon. This may be written:—

$$\text{Volume of parallelepipedon} = V \text{ (cubic feet)} = L \times B \times D.$$

The volume of displacement may then be expressed as a *percentage* of the volume (V) of the parallelepipedon.

The technical term for such percentages is “coefficient of fineness,” expressing, as it does, the extent to which the immersed part of a ship is reduced from the parallelepipedon, or “fined.” The following table gives values for several classes of ships:—

Classes of steam-ships.	Coefficient of fineness. Displacement \div volume V .
1. Swift steamers (fine forms); her Majesty's yachts; cross-channel packets, etc.	Percentage. 40 to 50
2. Swift steam-cruisers, corvettes and sloops, Royal Navy; first-class ocean passenger steamers of very high speed	45 to 55
3. Steam gun-vessels, etc., Royal Navy; passenger steamers (common forms)	55 to 65
4. Latest classes of wood steam line-of-battle ships and frigates, and early types of sea-going ironclads, Royal Navy	50 to 55
5. Recent sea-going battle-ships; later types of rigged ironclads, Royal Navy	55 to 65
6. Earlier mastless sea-going ironclads of moderate speed; cargo and passenger steamers of moderate speed	62 to 70
7. Cargo-carrying steamers, ordinary types, low speed	65 to 78

To these approximate rules for steamers, a few corresponding rules for sailing ships may be added. In the obsolete classes of war-ships the displacements ranged from 40 per cent. of the volume of the parallelepipedon, in brigs, to 45 per cent. in frigates and 50 per cent. in line-of-battle ships. It is to be observed that these vessels had comparatively deep keels and false keels, especially the smaller classes; which circumstance tended to make their "coefficients of fineness" (or percentages) appear smaller than they would otherwise have done. In modern racing yachts, with very deep keels, the percentages vary from 22 to 33; in modern merchantmen the percentages usually lie between 60 and 70.

These approximate rules cannot be substituted for exact calculations of displacement—they are of service only in enabling a fairly accurate estimate to be made when the principal dimensions and character of a ship are known; and in selecting the appropriate coefficient of fineness regard must be had to the qualities of a vessel, particularly her speed if she is a steam-ship. The coefficients in the table are sometimes styled "block coefficients," to distinguish them from other coefficients used in tabulating or comparing the forms of ships. As measures of comparative fineness, naval architects commonly use so-called prismatic coefficients, which express the ratios of the volumes of displacement to the volumes of the right cylinders, described upon the greatest immersed athwartship sections (or mid-ship sections) of ships, the lengths of these cylinders being identical with the lengths of the ships at the water-line.

As an example of the application of the foregoing tabulated coefficients, a first-class cruiser of the *Edgar* type may be taken. These vessels have maximum smooth-water speeds of from 20 to 21 knots, their forms are very fine, and 50 per cent. is an appropriate coefficient. Length (L)=360 feet; breadth (B)=60 feet; mean draught (D)=23.75 feet.

Volume of parallelepipedon (V) = $360 \times 60 \times 23.75 = 513,000$ cub. ft.

" " displacement = 50 per cent. of V = 256,500 cub. ft

Displacement (in tons) by rule = $256,500 \div 35 = 7328$ tons.

Actual displacement = 7350 tons.

Ships vary in their draught of water and displacement as the weights on board vary. In cargo-carrying merchant vessels this variation is most considerable, their displacement without cargo, coals, or stores often being only one-third of the load displacement. In ships of war the variation in displacement is not nearly so great, but the aggregate of consumable stores reaches a large amount, and when they are out of a ship, she may float 2 or 3 feet lighter than when fully laden. Naval architects have devised a plan by which,

without performing a calculation for every line at which a ship may float, it is possible to ascertain the corresponding displacement by a simple measurement. Fig 2 illustrates one of the "curves of displacement" drawn for this purpose; it is constructed as follows. The displacements up to several water-lines are obtained by direct calculation from the drawings of the ship, in the manner before mentioned. Then a line AB is drawn, the point A representing the under side of the keel, and the length AB representing the "mean draught" of the ship when fully laden; this mean draught being half the sum of the draughts of water forward and aft. Through B a line BC is drawn at right angles to AB, the length BC being made to represent, to scale, the total displacement of the ship when fully laden; an inch in length along BC representing, say, 1000

FIG. 2.

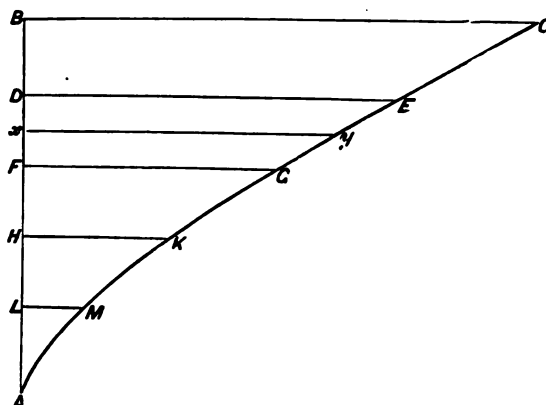

tons of displacement. Suppose the displacement to have been also calculated up to another water-line (represented by DE in the diagram) parallel to and at a known distance below the load-line (BC). Then on DE a length is set off representing this second displacement on the same scale as was used for BC. Similarly the lengths FG, HK, and so on, are determined, and finally the curve CEG . . . A is drawn through the ends of the various ordinates. When this curve is once drawn, it becomes available to find the approximate displacement for any draught of water at which the ship may float, supposing that she does not very greatly depart in *trim* from that at which she floats when fully laden.* For instance, suppose the mean draught for which the displacement is required to be 4 feet lighter than the load-draught. Set down Bx representing the 4 feet, on the same scale on which AB

* By "trim" the naval architect means the *difference in draught* at the bow of a ship from that at the stern.

represents the mean load-draught. Through x draw xy perpendicular to AB to meet the curve, and the length xy (on the proper scale) measures the displacement at the light draught. This brief explanation will render obvious the great practical usefulness of curves of displacement, which always form part of the calculations attached to the designs of ships.

Another problem that frequently occurs is the determination of the increased immersion which will result from putting a certain weight on board a ship when floating at a known draught, or the decreased immersion consequent on removing certain weights.

Here again the naval architect resorts to a graphic method in order to avoid numerous independent calculations. The diagram, Fig. 3, represents a "curve of tons per inch immersion;" the horizontal measurement from the base-line AB representing (on a certain scale) the number of tons which would immerse the ship one inch when she is floating at the draught corresponding to the ordinate along which the measurement is made.

The construction of this curve is very similar to that of the curve of displacement in Fig. 2, the successive points on the curve being found for the equidistant water-lines, BC , DE , FG , etc., by direct calculation from the drawings of the ship; and the length of the ordinate xy determining the number of tons required to immerse the ship one inch when floating at any mean draught, Ax . In this case also it is to be understood that at the various mean draughts considered there are no considerable departures in trim from that of the fully laden ship.

It will be observed in the diagram that the upper part of the curve of tons per inch is very nearly parallel to the base-line AB ; this arises from the well-known fact that, in the neighbourhood of the deep load-line of ships of ordinary form, the sides are nearly upright, and there is little or no change in the areas of the horizontal sections. For all practical purposes, in most ships, no great error is involved in assuming that twelve times the weight which would sink the ship one inch below her load-line will sink her one foot, or that a similar rule holds for the same extent of lightening from the load-draught. In fact, it is very common to find this rule holding fairly for 2 feet or more on either side of the fully laden water-line. A rule which gives a fair approximation

FIG. 3.

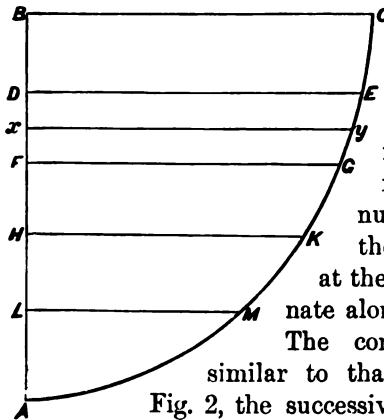

For any other density of water than that assumed above, the correction would be made in a similar manner. As a numerical example, take a ship having the following particulars: Weight = $W = 6000$ tons; tons per inch at load-draught in sea-water = $T = 30$.

$$\left. \begin{array}{l} \text{Increased draught on entering London} \\ \text{docks as compared with her draught} \\ \text{at the Nore} \end{array} \right\} = \frac{6000}{63 \times 30} = 3\frac{1}{3} \text{ inches.}$$

The draught being observed when the vessel is about to leave the sea, the curves of displacement and tons per inch will furnish the corresponding values of W and T in the foregoing expressions.

The converse case, where a ship, on passing from a dock or river to the sea, floats at a less draught, is of considerable importance to merchant ships, exercising an appreciable effect upon their freeboard when deeply laden. This variation in draught is provided for in the tables prepared by the Load-line Committee of 1884–85, and embodied in the Merchant Shipping Act of 1890. Samples of water were weighed in the various ports, harbours, and rivers of the United Kingdom, and were found to vary from 1000 ounces per cubic foot of fresh water, to 1025 ounces for the densest sea-water on the British coast. The diminution in draught, or “rise,” of ships in passing from the lightest to the densest water is expressed in terms of the “moulded depths” of the ships, ranging between 2 inches for a moulded depth of 9 feet, to 6 inches for a depth of 34 feet in vessels without erections on deck. Suitable rules are laid down also for other types of vessels and for intermediate densities of water at loading-berths.

Reserve of Buoyancy.—The buoyancy of a ship has already been defined, and shown to be measured by the displacement up to any assigned water-line. “Reserve of buoyancy” is a phrase now commonly employed to express the volume, and corresponding buoyancy, of the part of a ship not immersed, but which may be made watertight, and which in most vessels would be enclosed by the upper deck, although in many cases there are watertight enclosures above that deck—such as poops, forecastles, bridge-houses, etc. The under-water, or immersed, part of a ship contributes the buoyancy; the out-of-water part the reserve of buoyancy, and the ratio between the two has a most important influence upon the safety of the ship against foundering at sea. The sum of the two, in short, expresses the total “floating power” of the vessel, and the ratio of the part which is utilised to that in reserve is a matter requiring the most careful attention.

In Figs. 4–9 are given illustrations of the very various ratios which the reserve of buoyancy bears to the volume of displacement

in different classes of war-ships. As this is only a matter of ratio, a box-shaped form has been employed instead of a ship-shaped, and in all cases the volume of displacement is the same, so that the out-of-water portions can be compared with one another as well as with the displacement.

Fig. 4 represents the condition of low-freeboard American monitors, such as the *Canonicus* or *Pas-saic*, which were employed on the Atlantic coast during the civil war. The upper decks of these vessels are said to have been between 1 and 2 feet only above water; their reserve of buoyancy was only about 10 per cent. of the displacement.

Fig. 5 represents the condition of the American monitor *Miantonomoh*, with a reserve of buoyancy of about 20 per cent. of the displacement; this approximately shows her state when she crossed the Atlantic in 1866, but all openings on her upper deck, which was about 3 feet above water, were carefully closed or caulked.

Fig. 6 represents the *Cyclops* class of breastwork monitors in the Royal Navy as first completed. The upper decks of these vessels were originally about the same height above water as that of the *Miantonomoh*, but, by means of an armoured breastwork standing upon the upper deck, the reserve of buoyancy was increased to 30 per cent. of the displacement. For sea-service,

FIG. 4.

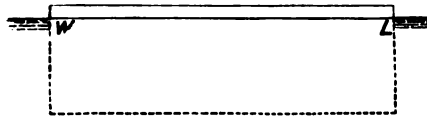

FIG. 5.

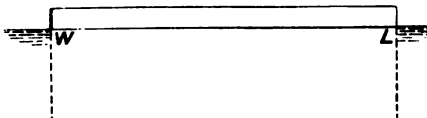

FIG. 6.

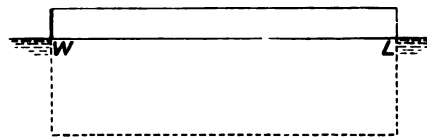

FIG. 7.

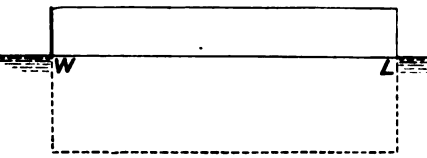

FIG. 8.

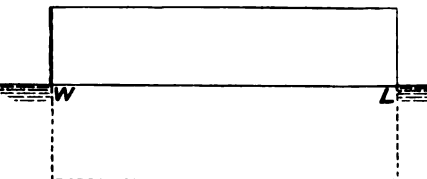
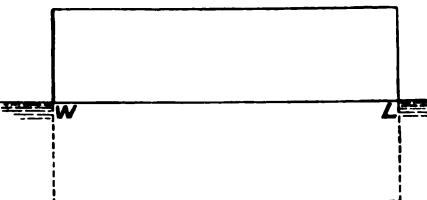

FIG. 9.



when making passages, the conditions of stability were not considered satisfactory, and light superstructures have been added, bringing the vessels into practically the same category as the *Devastation* class (Fig. 7), in which the reserve of buoyancy is 50 per cent. of the displacement.

Fig. 8 represents armoured and other vessels of high freeboard, in which the reserve of buoyancy reaches 80 or even 90 per cent. of the displacement.

Fig. 9 represents ships of high freeboard and fine under-water form, in which the reserve of buoyancy is equal to, or even greater than, the displacement.

In the foregoing examples the ratios of reserve of buoyancy to volume of displacement have been given. This is usual for war-ships. In merchant ships it is customary to express the reserve of buoyancy as a percentage of the whole buoyant volume; that is, of the sum of the buoyancy and reserve of buoyancy. The case of merchant ships is not nearly so simple as that of war-ships; chiefly for two reasons. First, in war-ships certain specified weights have to be carried in definite positions, and a fixed load-line forms part of the design; whereas, in merchant ships, with few exceptions, a varying cargo has to be provided for, and until recently there was no generally accepted rule for fixing maximum load-lines, nor any legal enactment on the subject. Second, there are very great varieties in the character and extent of superstructures and deck-erectments in different types of merchant ships; and considerable difficulties have to be overcome in assigning values to such erections when estimating reserves of buoyancy or assigning freeboards.

Rules for freeboard.—Freeboard, in its common use, means the height of the upper deck amidships at the side, above the water-line. If a thick "water-way" is fitted on the edge of the deck, the excess of its thickness above the ordinary thickness of the deck-plank would not be reckoned into the freeboard; in other words, freeboard is measured from a continuation to the side of the upper surface of the deck-planking or plating. In some special types, with light superstructures, freeboard is measured to the main deck. Ordinarily, freeboard is expressed in feet and inches. Fixing the minimum freeboard, of course, determines the maximum load-line for a ship. The oldest rules for freeboard were based on "depth of hold," ships to which these rules applied being of simple types with nearly flush upper decks. Probably these rules were intended to roughly proportion the relative volumes of the in-water and out-of-water parts of ships when floating in still water. "Lloyd's Rule," for example, was—

Freeboard = from 2 to 3 inches per foot depth in hold.

Although this rule was commonly used, it had no legal force, and took no account of varying degrees of "fulness" of form, nor of the influence upon relative freeboard which increase in the sizes of ships should have. The Liverpool underwriters attempted to correct these faults, by directing their surveyors to make allowance for form and strength when assigning freeboards, and by providing graduated scales of freeboard, ranging from $2\frac{1}{4}$ inches per foot depth in hold of small vessels, to as much as 4 inches in large vessels. Similar rules for freeboard were also employed in foreign countries, and in some cases associated with tonnage measurements. The results in working were not satisfactory, especially after the period when steam-propulsion and iron gave rise to rapid developments in the sizes and types of merchant ships.

In 1867 the council of the Institution of Naval Architects took up this question, proposing to make the freeboard of ships mainly dependent on the beam. Their rule was as follows:—

Freeboard = one-eighth the beam, with the addition of one-thirty-second part of the beam, for every beam in the length of the ship, above five beams.

For example, a ship 160 feet long, and 32 feet beam, is *five beams* in length; freeboard = $\frac{1}{8} \times 32 = 4$ feet. If she were 192 feet in length, or *six* beams (one beam in excess of the five); freeboard = $\frac{1}{8} \times 32 + \frac{1}{32} \times 32 = 5$ feet. If she were 224 feet long, or seven beams; freeboard = $\frac{1}{8} \times 32 + \frac{2}{32} \times 32 = 6$ feet. And so on. This rule obviously fails by the omission of any reference to the *depth* of the ship; deep, narrow ships, which would require exceptional freeboard in consequence of their bad proportions, would by this rule gain upon better-proportioned vessels, and have a relatively low freeboard granted to them. Moreover, in the very long vessels now commonly employed, say with a length *ten* times the beam, the allowance for the additional *five* beams would be proportionately very great—in fact, the freeboard required by the rule might be excessive. On the whole, therefore, in spite of the authority on which the proposed rule rested, it is not surprising that it never came into use.

The freeboard of war-ships is regulated largely by considerations of fighting efficiency, such as height of guns above water, distribution of armour, and intended service. No fixed rule applies to all classes. In a coast-defence vessel, such as the *Glatton*, the freeboard (to upper deck) is only about 3 feet; there is also a "breastwork" with its deck about 10 feet above water. In seagoing turret ships of moderate freeboard the upper decks are from 9 to 10 feet above water. The low ends of the barbette ships of the

Admiral class have a freeboard of about $10\frac{1}{2}$ feet, while the central portions have a freeboard of 17 feet. The latest first-class battle-ships (*Royal Sovereign* class) have freeboards of 17 feet 3 inches. It is now generally accepted that high freeboard at the extremities is essential to the maintenance of speed in a sea-way. Cruisers of the latest types and largest size have their continuous upper decks from 15 to 18 feet above water, associated in some cases with long forecastles rising about 7 feet higher. For the smaller classes of cruisers, long and high poops and forecastles are usually associated with upper decks at moderate heights above water.

No fixed rules are followed in assigning freeboards to yachts; in competing designs considerable variations occur. According to Mr. Dixon Kemp, good practice may be represented by the empirical rule—

$$\text{Freeboard (in feet)} = \text{factor} \sqrt[1.8]{\text{beam (in feet)}}.$$

The "factor" in this rule varies considerably. In a sailing yacht of about $4\frac{1}{2}$ beams in length, or a steam-yacht of 6 beams in length, the factor is said to be roughly $\frac{7}{10}$; in a sailing yacht 7 beams in length, or a steam-yacht 8 beams in length, the factor becomes unity. No coal is supposed to be on board the steam-yachts when the freeboards are measured. This attempt at methodical treatment of yacht freeboards is interesting, but no doubt differences in design will continue to prevail.

Load-line legislation for merchant ships.—During the period 1870-90 many inquiries were made by commissions and committees into matters affecting the safety and seaworthiness of merchant ships. In all cases the question of depth of loading necessarily came into prominence, and the desirability of rules for fixing freeboards was acknowledged. The difficulties involved were considered insuperable for a time, and the Royal Commission of 1874 reported that no general rules could be laid down. Ship-owners as a body were averse to legislation on the subject, and preferred to retain freedom even if associated with responsibility. By Acts of Parliament in 1875-76 their responsibility was affirmed, and they were compelled to mark on the sides of all ships engaged in oversea trade the load-line which was not to be exceeded, as well as the positions of the decks. Official surveyors had authority to detain ships considered to be overladen, subject to claims for damages by the owners. Naturally friction arose under these conditions, no authoritative or generally accepted rules being available for the guidance of either owners or surveyors. Many attempts were made to frame such rules, without success. A settlement was finally reached on the basis of action taken by the Committee of Lloyd's

Register of Shipping, on the initiative of their chief surveyor, Mr. Martell.* For nearly ten years Mr. Martell and his colleagues persevered in the compilation of data respecting the loading of various types of ships, the scientific analysis of these facts, and the framing of tables of freeboard. In 1882 Lloyd's Committee issued these tables, which were soon extensively used in assigning freeboards. A strong and representative committee was appointed by the Board of Trade at the end of 1883 to consider the practicability of framing general rules for freeboard, which would prevent dangerous overloading without unduly interfering with trade. Sir Edward Reed was chairman; the Board of Trade, the Registry Societies, the Admiralty, the Institution of Naval Architects, shipowners, and shipbuilders were all represented. In August, 1885, the committee reported in favour of adopting Lloyd's tables with limited modifications. The Board of Trade acted on this recommendation. From 1886 to 1890, certificates of freeboard issued by Lloyd's were accepted by the Board of Trade surveyors. Shipowners, therefore, who obtained Lloyd's certificates, and had their ships properly marked, were freed from the possibility of detention for overloading, provided the assigned minimum freeboards were maintained. By July, 1890, two thousand two hundred vessels had been granted Lloyd's certificates on the voluntary application of the owners. In June, 1890, an Act of Parliament was passed which made compulsory on all British vessels of above 80 tons' register the assignment and marking of a maximum load-line, determined in accordance with the tables framed by the Load-line Committee. Provision was also made in the Act for "such modifications, of any of the tables and the application thereof, as may from time to time be sanctioned by the Board of Trade." Under the terms of the Act freeboards may be assigned and certified by the Committee of Lloyd's Register; or, at the option of shipowners, any other corporation or association for the survey or registry of shipping approved by the Board of Trade, or any officer of the Board specially selected for the purpose. Up to the present time (1893), two registries besides Lloyd's have been approved by the Board of Trade; viz. the Bureau Veritas and the British Corporation. As might naturally be expected, however, from the facts above stated, the officials of Lloyd's Register have continued to perform by far the largest portion of the work of assigning freeboards.

Reference must be made to the published report of the Load-line Committee, and to the freeboard tables appended thereto, by

* See Mr. Martell's "Review of the Load-line Question." London: 1887. We have to thank Mr. Martell for much valuable information on the subject.

readers desirous of obtaining full particulars of their procedure.* The objects of the committee may be briefly summarized in the statement that they aimed at fixing load-lines so as to secure—(1) a regulated minimum percentage of the total buoyant volume as a reserve of buoyancy; (2) a sufficient height of deck above water; (3) a freedom from excessive stresses being brought upon the materials in the structures of laden ships. Although not expressly mentioned in the report, it is understood that the committee also considered the relation of the load-line to stability. In the freeboard tables, only cargo-carrying vessels are dealt with. In passenger vessels, of course, the provision of good accommodation in portions of the ships situated above water, necessitates relatively high freeboards. All classes of cargo-carriers are provided for, consideration having been given to various types, dimensions, proportions, forms, and structural arrangements. Experience gained in the actual loading and working of different classes of ships was largely drawn upon in framing the tables; but scientific analysis and investigation were also fully employed in dealing with *data* obtained from experience.

As standards of strength, the committee took scantlings such as would satisfy the highest class at Lloyd's, or be equivalent thereto. For ships more lightly built, it was laid down that their depths of lading were to be suitably diminished, and the freeboards correspondingly increased; so that the material of the hull might not be subjected to severer stresses than are accepted for vessels of the same dimensions and forms, but of the standard strength. The freeboards tabulated are understood to apply to vessels having such a relation of breadth to depth as will ensure safety at sea when homogeneous cargoes are carried. For vessels of less relative breadth, it is stipulated that either the freeboards shall be increased so as to provide a sufficient range of stability, or other means adopted to ensure that range (see Chapter III.). Detailed directions are given for dealing with unusual conditions of sheer of deck, round of beam, trim, etc., and with extreme proportions of length to depth, as well as with deck erections and superstructures. The committee, while recording the opinion that their tables could be adopted for existing types of vessels for some years, were careful to emphasise the necessity for allowing to responsible authorities

* The Board of Trade has also issued various memoranda for the guidance of authorities assigning load-lines. The latest of these (November, 1892) was based on the work of a departmental committee, who made various amend-

ments and extensions of previous rules, with a view to securing uniformity of practice. It is impossible here to give details of these matters, which leave the principles explained above unchanged.

assigning freeboards a large discretion in future applications of the tables. This is obviously essential, if there is to be no undue interference with trade, or with the development of ship-construction, in years to come.

The tabulated freeboards are for sea-water and for winter voyages. For summer voyages specific reductions of freeboard are made, and for winter voyages in the North Atlantic greater freeboards are required.

Certain standard proportions of length to depth are assumed for vessels of which the tabulated freeboards are given. There are four sets of tables, all for flush-deck vessels, and deck erections or superstructures are dealt with independently. Tables A relate to steam-vessels (such as Fig. 10) not having spar or awning decks,

FIG. 10.
FLUSH DECK VESSEL.

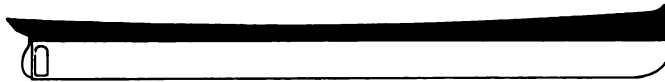

with the full strength of structure carried to the upper decks. Tables B relate to "spar-deck" steam-vessels (such as Fig 11), in

FIG. 11.
SPAR DECK VESSEL.

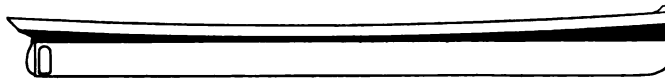

which the scantlings throughout are somewhat lighter than for the preceding class, and the scantlings from the spar to the main deck may be relatively lighter than those below the main deck. Tables C relate to "awning-deck" steam-vessels (such as Fig. 12), which

FIG. 12.
AWNING DECK VESSEL.

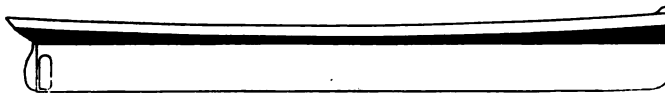

are more lightly built aloft than the spar-deck class. Tables D relate to sailing vessels, distinguishing between wood, composite, and iron or steel. In the first and fourth tables, "moulded depths" are measured, in iron or steel vessels, from the top of upper deck beam at side at the middle of the length to the top of keel; in spar or awning-deck vessels, the corresponding depth is measured from the top of the main-deck beam. The standard ratios of length to

moulded depth assumed in the tables are: In classes A and C, 12 to 1; and in class D, 10 to 1. For spar-deck ships, assuming that the spar deck is 7 feet above the main deck, the standard length is assumed to be twelve times the depth to the spar deck. Provision is made for departures from these standard ratios, by corrections for each change of 10 feet in length stated at the foot of the tables. Freeboard has to be increased if the actual length for a certain moulded depth exceeds the standard, and may be diminished if the actual length is below the standard. For class A, the correction for a change of 10 feet in length varies from $\cdot 8$ inch for ships of 10 feet moulded depth, to 1.7 inch for ships of 34 feet moulded depth. Similar corrections are specified for other classes. In spar and awning-deck vessels, the corrections are less than for flush-deck vessels; that for an awning-deck ship 34 feet in moulded depth and 408 feet long being only $\cdot 8$ inch, whereas a spar-deck vessel of the same length would have a correction of 1.4 inch.

For vessels of standard proportions, the Tables A, C, and D give the minimum percentages of reserve buoyancy. In Table A, these percentages vary from 22 per cent. for ships of 10 feet moulded depth, up to 35 per cent. of the total buoyancy in ships where that depth is 34 feet. Awning-deck vessels have their "reserves of buoyancy" estimated to the *main* deck only. Although a large volume is enclosed and made watertight by the light superstructure and awning deck, such ships cannot, with safety, be nearly so deeply laden as flush-deck ships under Table A. For awning-deck ships of 14 feet moulded depth, the percentage of buoyancy is specified as 15 per cent., and for vessels where that depth is 34 feet, it is 28 per cent. It will be seen, therefore, that a considerable allowance is made for the increased buoyant volume enclosed by the light superstructure. For sailing ships, the reserves of buoyancy vary from 23.5 per cent. in vessels of 10 feet moulded depth, to 33 per cent. in vessels 31 feet deep. Spar-deck vessels have no specified percentages of buoyancy, heights of freeboard only being tabulated.

It may be interesting to compare the freeboards assigned to vessels in classes A, B, and C, alike in length, breadth, and form, but differing in structure. Taking 360 feet as the length, a vessel of standard proportions in Table A would be 30 feet in moulded depth, and should have a minimum winter freeboard of 7 feet $3\frac{1}{2}$ inches, measured to her upper deck. A spar-deck ship of the same external dimensions and form would be required to have a freeboard of 7 feet $11\frac{1}{2}$ inches to her spar deck; that is to say, she would have 8 inches less draught of water allowed her because of her lighter construction. An awning-deck ship of the same length and form up to the main deck, would have the light superstructure rising about 7 feet above

the main deck. Her freeboard to the main deck would be about 5 feet, although her apparent freeboard (to awning deck) would be fully 12 feet, as against an apparent freeboard of 7 feet 3½ inches in the more strongly built vessel.

By means of a "curve of displacement" like that described on p. 5, but constructed so as to include the whole external volume of a ship up to the upper surface of the deck, which is assumed to bound the reserve of buoyancy, it is a very easy process to fix the load-line giving any specified percentage for that reserve. For newly designed ships this method will doubtless be followed commonly. In order to deal with existing ships when the system was introduced, and to economize labour, Mr. Martell devised an approximate method, which was adopted by the Load-line Committee, and embodied in their tables. It has been found, on investigation, that the *internal volumes* of ships under the upper decks bear a closely defined ratio to the *external bulk*. This internal capacity is known from the tonnage measurements (see p. 56), and represents the "under-deck tonnage" multiplied by 100. As a fairly accurate measure of the *form* of a ship, Mr. Martell therefore took—

$$\text{Coefficient of fineness} = \frac{\text{under-deck tonnage} \times 100}{\text{length} \times \text{extreme breadth} \times \text{depth of hold}}$$

These coefficients of fineness are tabulated, and the freeboards increase with increase in the coefficients. For instance, a flush-deck vessel 240 feet long, and 20 feet moulded depth, with a coefficient .68, would have a minimum freeboard of 3 feet 7½ inches; whereas, if the coefficient rose to .82, the freeboard would have to be 4 feet, in order to give the required reserve of buoyancy.

Deck-erectments in merchant ships, as already explained, vary greatly in extent and character. The ingenuity of shipbuilders and shipowners has been, and no doubt will continue to be, exercised in modifying practice, and endeavouring to increase earning power in relation to tonnage, while maintaining seaworthiness.* In dealing with these erectments, the Load-line Committee undertook a very difficult and laborious duty. The explanations of their freeboard tables contain rules for guidance in making allowances for erectments of all classes of ships in existence at that time. Details must be sought in the rules themselves. The broad principle followed is to take each class separately, and have regard to the length, height,

* See *inter alia* Mr. Martell's paper "On the Alterations of Types and Proportions of Mercantile Vessels:" *Transactions* of the Institution of Naval Architects, 1892; and a paper by Messrs

Jordan and Marlborough, on "Types and Proportions of Mercantile Steamers," in the *Transactions* of the North-East Coast Institution of Engineers and Shipbuilders, 1892-93.

strength, and character of the several erections. The ratio of the combined length of the erections to the length of the vessel is generally used as a guide in assessing the reduction to be allowed in the freeboard and reserve buoyancy under deck. Comparing flush-deck vessels in Table A with awning-deck vessels of the same dimensions and form (to main deck) in Table C in the manner above explained, the total diminution in freeboard corresponding to a complete awning deck can be ascertained. Then a proportion of this diminution is taken for erections covering a certain part of the length only. As an example, take the case of a vessel having a long poop, at least 4 feet in height, extending to a bridge-house amidships, and a forecastle (Fig. 13). If the combined length of these

FIG. 13.

VESSEL WITH ERECTIONS CONSISTING OF
FORECASTLE, BRIDGE HOUSE, RAISED QUARTER DECK AND POOP.

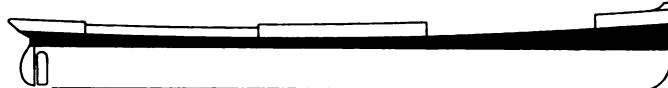

erections is 90 per cent. of the ship's length, the freeboard may be reduced from that required for a flush-deck vessel by 85 per cent. of the reduction which by the tables would be permitted if a complete awning deck were fitted. Supposing the erections to aggregate only 60 per cent. of the ship's length, the reduction in freeboard may be 50 per cent. of the reduction corresponding to an awning deck. Other combined lengths of erections carry proportionate reductions in the type of vessel used as an example. If the height of poop above the upper-deck line is less than 4 feet, the reductions in freeboard have to be suitably diminished.

These rules for deck-erections are obviously empirical to a great extent. They have been carefully framed in view of existing types of cargo-carriers, and constitute a fairly satisfactory solution of a problem for which no strictly scientific solution can be found. Revisions of these rules and of other portions of the rules and tables will be required as ship-construction is developed and new types introduced. The Act of 1890 provides the necessary powers. For certain classes of ships owners have already asked for revision, alleging that the freeboards assigned are unnecessarily great, and that earning powers are unduly diminished. To meet these difficulties and provide for necessary revisions, a majority of the Load-line Committee recommended that the scientific staff of the Board of Trade should be strengthened, and that an advisory council of shipowners and shipbuilders should be formed. The Act of 1890, however, does not affirm this recommendation; it simply specifies that the Board

of Trade shall have regard to representations made by any corporation or association for the survey or registry of shipping appointed or approved by the Board for the purposes of the Act. Action has already been taken on this provision as explained above.

At present foreign nations have not adopted laws for compulsory load-lines. It is stated that some of the most important maritime powers are considering the matter with a view to action.* Obviously it is of the highest importance that British shipping should not be unduly hampered in its competition with foreign shipping. The Load-line Committee emphasised this principle, and advised that, if compulsory load-lines should be enforced, all foreign as well as all British ships, loading in British and colonial ports, should come under the same law. The Act of 1890 was passed primarily with a view to increased safety of life and property at sea. A careful analysis of losses in 1885-89, since the freeboard tables came into use, is said to indicate a sensible increase in safety and diminution in loss. This is satisfactory, and may tend to encourage similar legislation abroad. An international agreement for fixing load-lines has been suggested. Such an agreement practically exists for tonnage measurement. If an agreement is eventually arrived at, ships of different nationalities would compete on fairly equal terms as regards depth of loading.

Submarine and Surface Vessels.—Submarine or “surface” vessels, such as have been built or proposed for use in war, are subject to the same laws as other vessels when floating freely or at rest in still water, either at the surface or at any depth below it. The second class are not designed to be wholly submerged, but are intended to show little above water and to have an extremely small reserve of buoyancy in fighting condition. For making passages it may be desired to give them greater freeboard, in which case the fighting draught is reached by admitting water into compartments or tanks built for the purpose. Submarine vessels also are sometimes constructed similarly, so that they may associate the power of making passages at lighter draught, or of operating with a very small exposure, with a capability for diving when required. The last-mentioned operation involves arrangements by which the crew may control the vertical motions, either rising to the surface when necessary or sinking to any desired depth. Supposing the vessel to have been brought by admission of water to the condition where only a very small reserve of buoyancy remains, the operator may totally submerge her by various arrangements. If she has no onward

* A special commission is dealing with the question in France, but the report is not available at the time of the writing.

motion, submergence may be attained either by admitting a quantity of water just a little in excess of the small reserve of buoyancy, or by slightly diminishing the volume of displacement by withdrawing "plungers" which protruded when the vessel floated at the surface. In either case the weight of the vessel and its contents is made to *slightly exceed* the weight of water displaced by the total volume of the vessel. This excess in weight will cause a downward motion, rapidly accelerating unless checked; and the control of the descent so as to limit it to a specified depth is not easily effected by appliances which simply *vary the displacement*. Assuming this difficulty to be overcome, and the vessel to be floating (without vertical motion) at any depth, the general law must hold good that her total weight must equal the weight of water displaced. Consequently some of the water admitted for sinking must have been expelled, or the "plungers" must have been again thrust out to a certain extent. For all practical purposes, within the greatest depths at which submarine vessels are intended to operate, water may be treated as practically incompressible. As a very simple example of the arrangements which may fulfil the foregoing objects, take the following. Conceive a small cavity to be formed in the bottom of the vessel, and that, when this cavity is about *half full* of water, the total displacement of the vessel, when entirely submerged, just corresponds to the total weight. The other half of the cavity may be then kept filled with compressed air, which is in communication with an air-chamber in the interior of the vessel. The air in the air-chamber would be compressed sufficiently to have a considerable excess of pressure over that corresponding to the maximum depth of immersion at which the vessel is to be employed. When the compressed air is withdrawn from the upper half of the cavity, by an apparatus worked within the vessel, the water rises into the vacated space, the volume of displacement becomes decreased by that space, and is therefore less than will balance the weight; as a result, the vessel sinks. The desired depth being reached, compressed air stored within the vessel may be made use of to force the water once more from the upper half of the cavity, thus restoring equality between the weight and displacement; the vessel then remains at that depth. Lastly, when it is required to rise, by means of compressed air the water is wholly expelled from the cavity; the displacement then exceeds the weight, and consequently the vessel rises.

It will be obvious that if a vessel acquires a considerable velocity while descending to any assigned depth, as she may do if the operation is performed quickly, she will probably be carried much beyond that depth, even though her original displacement be restored by

expelling water from the balancing cavity. Conversely, if to make her rise again still more water be expelled, there is a risk of too great a vertical motion being produced; and so oscillatory movements may take place about the desired depth, or she may sink to a depth which will involve a dangerous pressure on the structure. Accidents of the kind have occurred, and in some of the best examples of this class of vessel precautions have been taken against them. One simple plan adopted in a French design and by Mr. Nordenfelt is to fit small screw propellers worked by power and carried on vertical shafts. These propellers may be used either to control vertical oscillations only, or to overcome the small reserve of buoyancy left before the vessel is submerged, and to keep the vessel at any depth. If the latter plan is followed, as soon as the propellers are stopped, the small excess of buoyancy over weight causes the vessel to begin to move towards the surface. Detachable ballast has been provided in some vessels, so as to ensure coming to the surface in case of accident to the controlling arrangements; and pumps for ejecting water-ballast have also been suggested for the same purpose. The greatest care in management as well as design is obviously necessary, in order to minimize the risks incidental to service in such vessels.

In other examples the submergence has been effected by giving onward motion to the vessels. Horizontal rudders have been fitted, under the control of the operators within the vessel. By placing these rudders in suitable positions, when the vessels are moving ahead an unbalanced vertical pressure is obtained, and the vessels are made to move upwards or downwards. When the rudders are horizontal, this vertical pressure disappears. In locomotive torpedoes similar rudders are fitted and automatically governed so as to keep the torpedoes at the desired depth below the surface.

Causes of foundering.—Ships founder when the entry of water into the interior causes a serious and fatal loss of floating power. There are two cases requiring notice. The first, and less common, where the bottom of the ship remains intact, but the sea breaks over and “swamps” the vessel. The second, that in which the bottom is damaged or fractured, and water can enter the interior, remaining in free communication with the water outside. Damage to the under-water portion of the skins of iron and steel ships is by far the most fruitful source of disaster; but many ships have foundered in consequence of being swamped, seas breaking over them, and finding a passage down through the hatchways into the hold.

The older sailing brigs of the Royal Navy are believed by many competent authorities to have been specially exposed to this danger. Very many of them were lost at sea; and their loss was believed

to have resulted from the lowness of their freeboard, the height of their bulwarks, and the insufficiency of the "freeing scuttles" in the top-sides to clear rapidly the large masses of water which lodged on the decks. In consequence, water accumulated, passed into the interior, and swamped them. The case of the steam-ship *London* furnishes another illustration. She is said to have been lost in consequence of a very heavy sea having swept away the covering of the engine hatchway, and left open a large aperture, down through which the water poured, putting out the fires, and leaving the ship a log on the water. Other seas washing over the unfortunate vessel completed the disaster, and she gradually sank. The United States monitor *Weehawken* also appears to have been lost in this manner. While forming part of the blockading squadron, and lying at anchor off Charleston with her hatchway forward uncovered, the weather being comparatively fine, a sea broke on the deck, poured down the open hatchway, and caused the vessel to sink rapidly—it is said in three minutes—her extreme lowness of freeboard and small reserve of buoyancy conducing to this end. Another, and slightly different, case in point may be found amongst vessels engaged in the timber trade. When these ships have been laden very deeply, and have carried deck cargoes, large quantities of water have been shipped, and the vessels have become "water-logged," and utterly unmanageable, even if they did not sink.

The condition of a water-logged ship naturally leads to the remark, that in any ship the maximum quantity of water that can enter the interior may or may not suffice to sink her, according as it is greater or less in weight than the reserve of buoyancy which the ship possesses. The maximum quantity of water that can enter the interior is determined by the *unoccupied space*; for to space which is already occupied by any substances—cargo, coals, engines, etc.—the water can obviously find no access. If the cargo be, like timber, very light, occupying a very large portion of the internal space, then it may happen that the total volume of the space unoccupied is less than that of the reserve of buoyancy, and the ship remains afloat; but this is not the common case, and if a vessel becomes swamped, and the sea finds access into all parts of the interior through the hatchways, she will most probably founder. Properly constructed and well-laden vessels are not, however, likely to founder in this fashion. Their hatchways and openings in the decks are carefully secured, and protected by high coamings and covers; while the interior is so subdivided into compartments, especially in iron and steel ships, that, if a sea breaks on board and finds its way down a hatch, it does not gain free access from the space thus entered to all other parts of the interior. Free water

which passes thus into a ship must considerably affect her behaviour in a seaway, although it may not jeopardize her safety: this case is considered in Chapter VI.

Turning next to the case of the ship of which the skin is penetrated below water, it is needless to cite examples of the possibly serious nature of such an accident. Very many illustrations will at

FIG. 14.

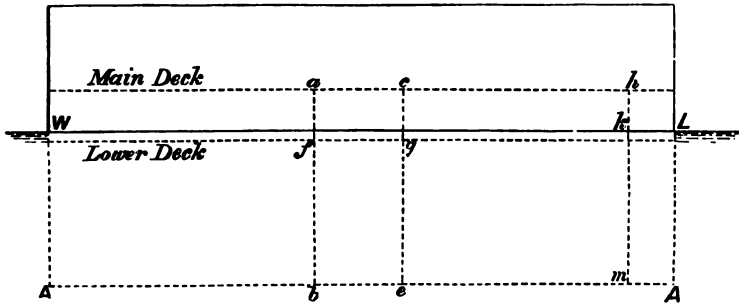

once occur to the mind of every reader, this being a very common source of loss now that iron or steel is generally used in building merchant ships. The causes of under-water damage may be various—such as accidental collision, local wear and tear, grounding, ramming, torpedo explosions, etc.—but in all cases water can enter the ship, and this water remains in *free communication* with the water outside. So long as that communication is maintained, water will

FIG. 15.

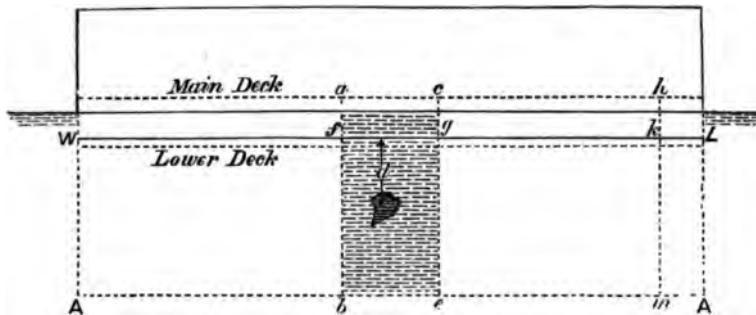

continue to pass into the ship until it can find access to no further space. If the water enters in such quantities as to exceed the reserve of buoyancy, the vessel sinks.

A simple illustration will render these statements clear. Take a box-shaped vessel, such as in Figs. 14 and 15, and suppose a hole to be broken through the skin under water. The water at once passes into the interior in quantities depending upon the area of the

hole and the depth it is below the water-level. A simple rule approximately expresses the initial rate of inflow.

Let A = area of the hole (in square feet).

„ d = the depth below water in feet (taken about the centre of the hole will be near enough for practical purposes).

Then, if v = velocity of inflow of the water in feet per second

$$v^2 = 64d \text{ (approximately); and } v = 8\sqrt{d};$$

so that, immediately after an accident, the volume of water passing into the vessel in each second

$$= 8\sqrt{d} \times A \text{ (cubic feet).}$$

Suppose, for example, the hole is 2 square feet in area, and has its centre 12 feet under water:

$$v = 8\sqrt{12} = 27\frac{1}{2} \text{ feet per second.}$$

$$\text{Water flowing in per second} = 27\frac{1}{2} \times 2 = 55\frac{1}{2} \text{ cubic feet.}$$

If the vessel floats in sea-water—

$$\text{Tons of water flowing in per second} = 55\frac{1}{2} \div 35 = 1.58.$$

Similarly, for any other depth or area of hole in the bottom of a ship, this rule will enable the rate of inflow to be determined very nearly.

Reverting to Fig. 14, it is obvious that, if the water can find free access to every part of the interior—which would be true if there were no partitions forming watertight compartments—the ship must sink: unless the power of her pumps is sufficient to overcome the leak; or some means is devised for checking the inflow, by employing a sail, or a mat, or some other “leak-stopper;” or the total unoccupied space in the interior is less than the reserve of buoyancy, a condition not commonly fulfilled. A consideration of the preceding formula for the rate of inflow will show that it is hopeless to look alone to the pumps to overcome leaks that may be caused by grounding, collision, ram attacks, or torpedo explosions; the area of the holes broken in the skin admitting quantities of water far too large to be thus dealt with.* Hence attention is directed to two other means of safety: the first, minute watertight subdivision of the interior of the ship, to limit the space to which water can find access; the second, the employment of leak-stoppers, which can be hauled over the damaged part, and made to stop or greatly reduce the rate of inflow. This latter is a very old remedy, Captain Cook having used a sail as a leak-stopper during his voyages, and many ships having

* For a full discussion of this point see a paper “On the Pumping Arrangements of War Ships,” contributed by

the author to the *Journal* of the Royal United Service Institution (1881)

been saved by similar means. It has acquired renewed importance of late, and various inventors have proposed modifications of the original plan, but all these are based upon the old principle of "stopping" the leak. Such devices are not embodied in the structure or design of ships, but form simply part of their equipment; whereas watertight subdivision is a prominent feature in the structure of a properly constructed modern iron or steel ship. It will be well, therefore, to sketch some of its leading principles. In doing so, we shall, for the sake of simplicity, make use of box-shaped vessels for purposes of illustration; but the conclusions arrived at will, in principle, be equally applicable to less simple forms, like those of ships.

Systems of Watertight Subdivision.—There are three main systems of watertight subdivision: (1) by vertical athwartship bulkheads; (2) by longitudinal bulkheads; (3) by horizontal decks or platforms. Besides these there is the very important feature of construction known as the "double bottom," the uses of which will be described further on. In Figs. 14 and 15 the hole in the skin, admitting water to the hold, is supposed to lie between two transverse bulkheads (marked *ab* and *ce*) which cross the ship and form watertight partitions rising to some height above the load-draught line (WL) and terminating at a deck marked "Main Deck." The great use of these bulkheads will be seen if attention is turned to Fig. 15, which represents the condition of the box-shaped vessel after her side has been broken through. The vessel has sunk deeper in the water than when her side was intact; and it is easy to determine what the increase in draught has been when one knows the volume (*fgeb*, in Fig. 14) of the damaged compartment, as well as the volume in that space which is occupied by cargo, or machinery, or other substances. To simplify matters, suppose this compartment to be empty; and assume the length *ac* to be one-seventh of the total length *AA*: then the volume *fgeb* will be about one-seventh of the total displacement; and when this compartment is bilged and filled with water up to the height of the original water-line WL, one-seventh of the original buoyancy will be lost. In fact, the compartment between the bulkheads no longer *displaces* water; in it the water-level will stand at the height of the surface of the surrounding water; and since the weight of the ship remains constant, the lost buoyancy must be supplied by the parts of the ship lying before and abaft the damaged compartment. For this reason we must have—

$$\begin{aligned} & \frac{2}{7} \text{ original water-line area} \times \text{increase in draught} \\ & = \frac{1}{7} \times \text{displacement} \\ & = \frac{1}{7} \times \text{original water-line area} \times \text{original draught.} \\ & \text{Increase in draught} = \frac{1}{7} \text{ original draught.} \end{aligned}$$

This very simple example has been worked out in detail because it illustrates the general case for ship-shape forms. The steps in any case are—

(1) The estimate of loss of buoyancy due to water entering a compartment; this loss being equal to the part of the original displacement which the damaged compartment contributed, less the volume in the compartment occupied by cargo, etc.

(2) The estimate of the increased draught which would enable the still buoyant portions of the vessel to restore the lost buoyancy if the entry of water were confined to the damaged compartment.

And to these, in practice, must be added—

(3) The change of trim (if any) resulting from filling the damaged compartment.

Reverting to Figs. 14 and 15, it will be obvious that, if the transverse bulkheads ab and ce did not rise above the original waterline WL, more than one-sixth of the original draught, they would be useless as water-tight partitions (unless the deck at which the bulkheads end forms a watertight cover to the compartment); because, when the compartment was bilged, their tops would be under water before the increase of draught had sufficed to restore the lost buoyancy. And when their tops are under water, the water is free to pass over the tops, or through hatchways and openings in the deck, into the adjacent compartments, thus depriving them also of buoyancy, and reducing the ship to a condition but little better than if she had no watertight partitions in the hold. Fig. 16

FIG. 16.

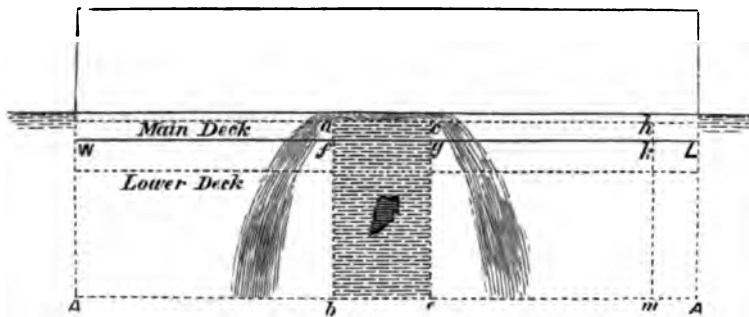

illustrates this serious defect. The main deck at which the transverse bulkheads ab and ce end is lower than in Figs. 14 and 15, all other conditions remaining unchanged; and consequently, when the compartment is bilged, the water can pour over the tops of the bulkheads into the spaces before and abaft.

Hence this practical deduction. Watertight transverse bulkheads can only be efficient safeguards against foundering when care

is taken to proportion the heights of their tops above the normal load-line to the volumes of the compartments, allowing for spaces occupied by cargo, stores, propelling apparatus, etc.; or else to make special provisions for preventing water from passing into adjacent compartments by means of watertight plating on the decks at which the bulkheads end, in association with watertight covers or casings to all hatchways and openings in the decks.

The midship compartments of a ship are usually the largest, and claim most attention; but those near the extremities are also important, because, although their volume may be small, when they are filled they cause a considerable *change of trim*. Reverting once more to our box-shaped vessel in Fig. 14, instead of supposing an empty midship compartment equal to one-seventh of the length to be filled, and to cause a loss of one-seventh of the buoyancy, let it be supposed that a compartment only half as long and half as large at one end (shown by $mkLA$ in the diagram) is filled. The increase in the mean draught due to this accident would be only one-thirteenth of the original draught, but the trim would be altered very considerably (as shown in Fig. 17); and the top of the bulk-

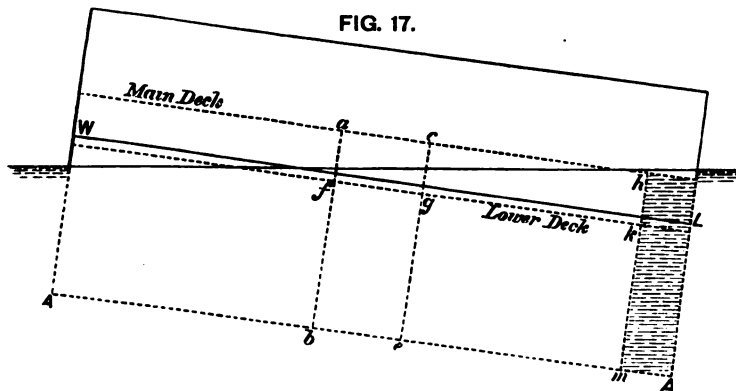

head hkm , although as high as those amidships, would be put under water by the change of trim. Consequently, unless the main deck is made watertight as far aft as the bulkhead hm , this very small compartment forward might, from its influence on the trim, be large enough to sink the ship; for when it is filled, if the deck does not form a watertight top to it, the water will pass over (at h) into the next compartment, the bow will gradually settle deeper and deeper, and at last the vessel will go down by the head. It will be in the recollection of many readers that ships which founder very commonly settle down finally either by the head or the stern, and the foregoing

simple illustration will furnish an explanation of some such occurrences.

It should be added that the assumptions made in the box-shaped vessel are fairly representative of actual ships. For example, in her Majesty's ship *Devastation*, if one of the large compartments amidships were filled, the ship would have an increased draught of about 15 or 16 inches, and her trim would be practically unaltered. If the aftermost compartments were filled, so as to give the ship an increase of 7 or 8 inches in the mean draught, the trim would be changed from $4\frac{1}{2}$ to 5 feet, and the tops of the bulkheads bounding these extreme compartments would be put under water. No evil would result, however, for these bulkheads are ended at a watertight iron deck.

Passing from transverse to longitudinal bulkheads, the same principles apply. The heights to which the bulkheads are carried should be carefully proportioned to the sizes of the compartments of which the bulkheads form boundaries; and watertight decks are no less useful as tops to such compartments when the bulkheads cannot be carried high enough to secure the restoration of the lost buoyancy. In this case, however, the longitudinal partitions, supposing only one side of the ship to be damaged, destroy the symmetry of the true "displacement," and the result is that the vessel heels over towards the damaged side. Transverse inclination takes place without change of trim if the damaged compartment is amidships; but if it be near the bow or stern, both change of trim and transverse inclination will result from the same accident. It is needless to do more than deal with the latter, as the influence of change of trim has already been described; and in this case the box-shaped vessel will once more furnish a simple illustration of what may happen in ships.

In Fig. 18, suppose the large midship compartment bounded by transverse bulkheads, *ab* and *ce* (in profile view), to be subdivided by longitudinal bulkheads, *pq*, *rs* (in section); in the positions shown, these longitudinal bulkheads fairly represent the coal-bunker bulkheads of an ironclad, being rather less than one-fourth of the breadth of the ship within the side. The "wing compartment" lying outside the bulkhead, marked *rs* in section, and *rr* in plan, Fig. 18, may be supposed to contain three-sixteenths of the total volume of the compartment between the transverse bulkheads *ab* and *ce*; reckoning up to the load-line WL, this will give—

$$\left. \begin{array}{l} \text{Loss of buoyancy when wing} \\ \text{compartment is filled with} \\ \text{water} \end{array} \right\} = \frac{3}{16} \times \frac{1}{4} \text{ total displacement} \\ = \frac{3}{112} \text{ total displacement.} \\ \text{Increase in mean draught} = \frac{3}{107} \text{ original draught.}$$

But this will be accompanied by a heel towards the damaged side, as indicated in the lower section (Fig. 18), amounting, in the

FIG. 18.

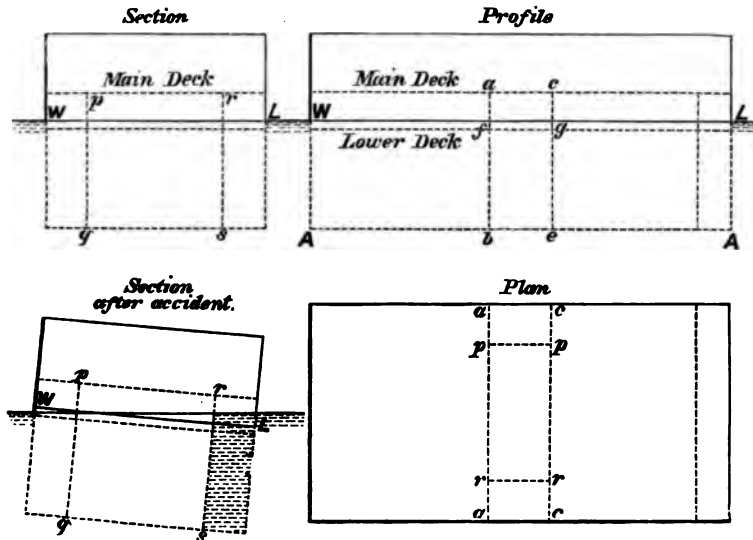

example chosen, to the immersion of the damaged side to about four times the extent of the increased mean draught due to loss of buoyancy. Hence it is clear that, in arranging longitudinal bulkheads, care must be taken either to carry them high enough to provide against heeling, or else to have watertight plating forming a top to the compartments. The amount of heel which may be produced by filling compartments bounded by such bulkheads must also be considered in connection with calculations of stability.

Lastly, attention must be directed to the usefulness of horizontal watertight decks or platforms in preventing loss of buoyancy. It is unnecessary to repeat what has been said respecting decks lying above the normal load-draught line, and forming tops to spaces enclosed by longitudinal or transverse bulkheads; consequently attention will be confined to the cases where a deck or platform lies below the load-line. In such cases either one of two accidents may be assumed to have happened: viz. the side has been broken through *below* the platform, or else *above* it. Turning to Fig. 19, let it be supposed that the large midship compartment bounded by the transverse bulkheads *ab* and *ce* has a watertight platform *pq* worked in it, at mid-draught. The volume of this compartment up to the load-line being *one-seventh* of the displacement, the buoyancy contributed by either of the parts into which it is divided by the platform will be *one-fourteenth* the displacement. If the side is broken

through below the platform, the whole of the water-line area WL contributes buoyancy when the vessel is immersed more deeply;

FIG. 19.

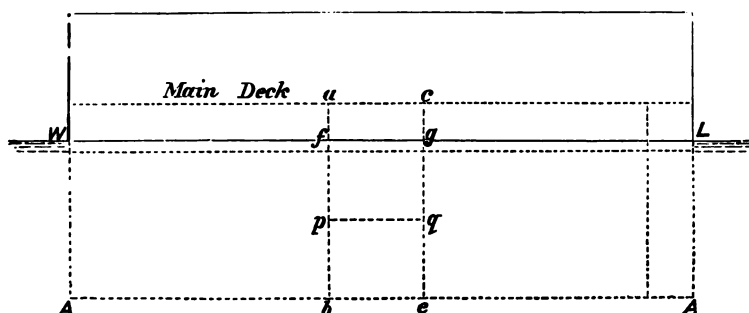

therefore, if the whole space is considered accessible to water (as shown in Fig. 20)—

FIG. 20.

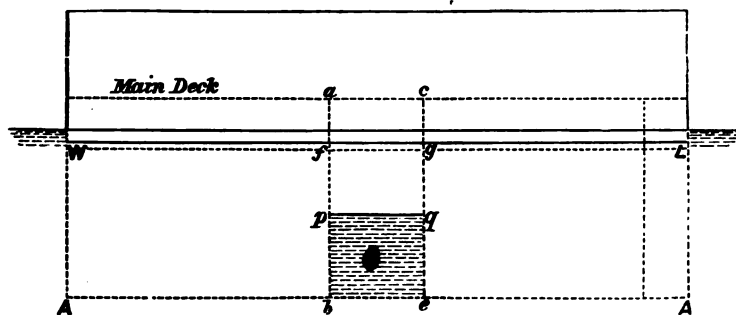

Increase in mean draught due to bilging compartment below pq } = $\frac{1}{14}$ original draught.

But if the side is broken through above the platform, only $\frac{6}{7}$ the water-line area contributes buoyancy; therefore (as shown in Fig. 21)—

FIG. 21.

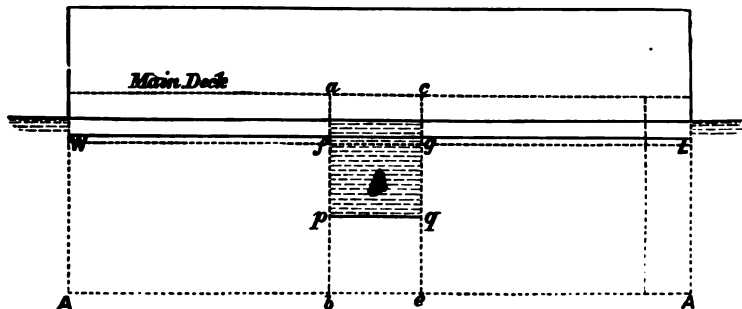

Increase in mean draught due to }
 bilging compartment above pq } = $\frac{1}{2}$ original draught.

This contrast shows how important a thing it is to take all possible measures to maintain the buoyancy of the ship at the load-line; for any decrease of that buoyancy not merely affects the draught of water, but also decreases the stability of a ship, as will be shown hereafter. It may be added that, in all cases where openings have to be made in a watertight deck or platform, either watertight covers must be fitted to the openings; or watertight trunks, carried to a sufficient height above the load-line, must be built around them.

Watertight Subdivision in War-ships.—All the methods of watertight subdivision illustrated above are associated in war-ships; and the minuteness of subdivision attained when care is taken is well exemplified in Figs. 22-29, which represent the arrangements of the water-tight partitions in a modern ironclad of the Royal Navy. Such vessels have the great safeguard of a “double bottom,” formed by a watertight inner skin fitted some distance within the outer skin. This inner skin extends from two-thirds to three-fourths of the total length of the ship; its terminations are marked cc in the profile view (Fig. 22), and the “plan of double bottom” (Fig. 24). From the keel up to the turn of the bilge, the inner skin is worked about 3 or 4 feet within the outer, as shown in the sections (Figs. 25-29), from the points a downwards. At a there is a watertight longitudinal partition (or frame), and the keel is also made watertight. Above the turn of the bilge, the inner skin (w, w in the sections) is usually worked vertically up to the height of the main-deck, thus enclosing “wing-spaces” in the region of the water-line, or, as it is termed, “between wind and water.” The inner skin is here often 8 or 10 feet within the outer. In addition to the longitudinal partitions at the bilges (a , in sections) and at the keel, the double bottom is subdivided by numerous watertight transverse partitions (shown by ff in Fig. 24), about 20 feet apart; compartments, of very moderate size, being thus formed between the two skins.

Within the limits of the double bottom, the hold-space is subdivided by means of transverse bulkheads ($b b$, Fig. 22), and longitudinal bulkheads ($l l$, Fig. 23). Before and abaft the double bottom there is only a single skin, and the subdivision is effected by means of transverse bulkheads and horizontal platforms ($p p$, Fig. 22). Although there is no inner skin at the extremities, the subdivision there is very minute, and the compartments are small owing to the fineness of form of the bow and stern. The “plan of hold” in Fig. 23, taken in connection with the profile (Fig. 22), will give a very complete view of the subdivision of the hold-space. Besides the main partitions already alluded to, it will be observed that, in

many cases, partitions required primarily for purposes of stowage or convenience are made watertight in order to make the subdivision

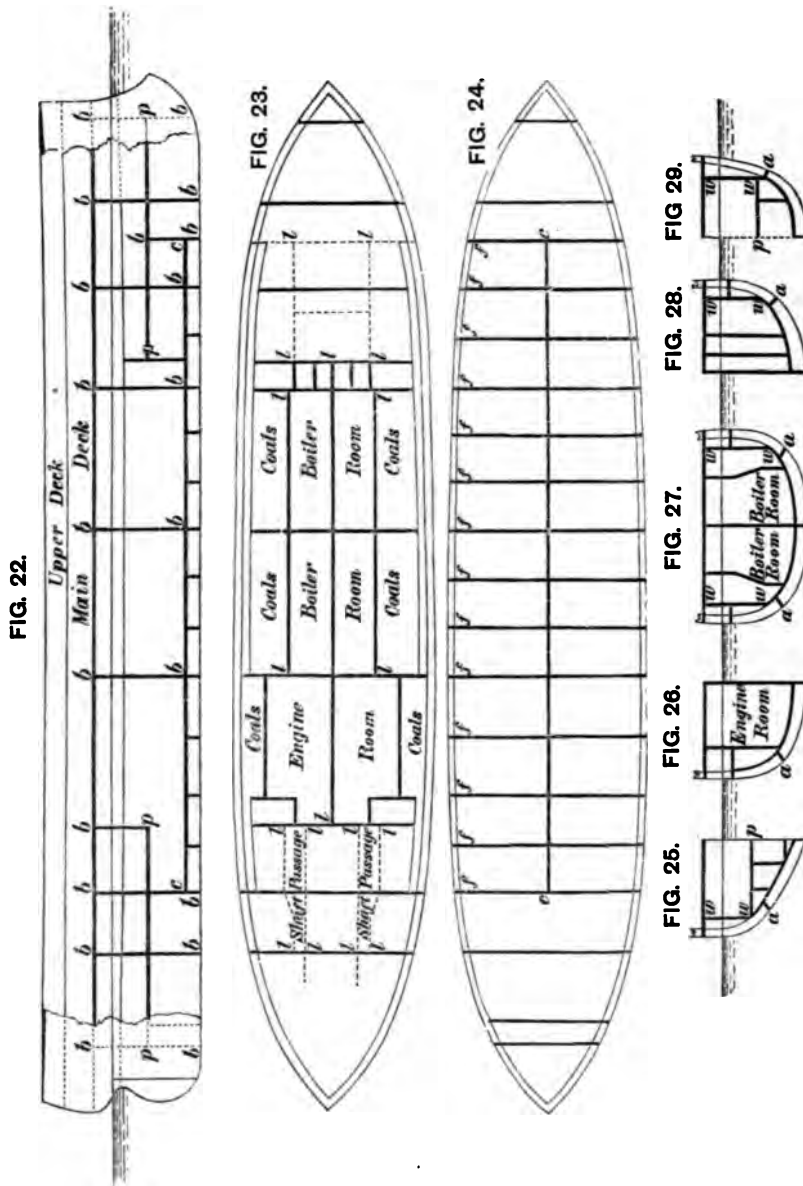

more minute. Examples will be found in the coal-bunker bulkheads, the chain-lockers (immediately before the boiler-rooms), the magazines and shell-rooms, and the shaft-passages. Slight increase of

cost and workmanship, with a very small increase in weight, are thus made to contribute to much greater safety. It will be noted that the principal bulkheads either run up to the main-deck, situated some 5 or 6 feet above water, or are ended at a watertight platform.

The spaces occupied by the machinery almost necessarily form large compartments amidships; but in recent war-ships the stokeholds have each been divided into two by means of a middle-line bulkhead (*ll* in Fig. 23); and in vessels propelled by twin-screws, as is the case in our example, the engine-room compartment is similarly halved. The great advantages resulting from this middle-line division are too obvious to need comment, especially in ships which are mainly or wholly dependent upon steam power for propulsion, and exposed to damage under water by shot or shell, ramming, and torpedo explosions.

The following table gives the number of compartments in several important ships of the Royal Navy:—

Armoured ships of Royal Navy.		Watertight compartments.		
Classes.	Names.	In hold-space.	In double bottom and wings.	Total.
Largest early types	<i>Warrior</i> . . .	35	57	92
	<i>Achilles</i> . . .	40	66	106
	<i>Minotaur</i> . . .	40	49	89
Smaller early types	<i>Hector</i> . . .	41	52	93
	<i>Resistance</i> . . .	47	45	92
Largest rigged types	<i>Monarch</i> . . .	33	40	73
	<i>Hercules</i> . . .	21	40	61
	<i>Sultan</i> . . .	27	40	67
	<i>Alexandra</i> . . .	41	74	115
	<i>Temeraire</i> . . .	44	40	84
Smaller masted types	<i>Invincible</i> . . .	23	40	63
	<i>Triumph</i> . . .	26	40	66
Belted ships	<i>Shannon</i> . . .	44	32	76
	<i>Nelson</i> . . .	83	16	99
Sea-going battle-ships (no sails)	<i>Devastation</i> . . .	68	36	104
	<i>Dreadnought</i> . . .	61	40	101
	<i>Inflexible</i> . . .	89	46	135
	<i>Royal Sovereign</i> . . .	90	55	145
Rams	<i>Hotspur</i> . . .	26	32	58
	<i>Rupert</i> . . .	40	40	80
Monitors	<i>Gorgon</i> . . .	19	20	39
	<i>Glatton</i> . . .	37	60	97

The *Devastation*, as originally built, may be taken as a good example of a modern war-ship, although she had no middle-line bulkhead in her engine and boiler rooms. Her double bottom and wings were divided into thirty-six compartments; the hold-space into sixty-eight compartments. If the three largest compartments of the hold (viz. the engine and boiler rooms) were filled, the vessel would only be immersed about $3\frac{1}{2}$ feet. With a middle-line bulkhead, like the later ships, each of these large compartments would be halved, and it would be improbable that both halves of any compartment would be filled simultaneously. The total number of compartments in the hold would then be seventy-one, and filling any six compartments amidships would immerse the vessel as before. The largest compartment in the double bottom holds only about fifty tons of water, corresponding to an increased immersion of only $1\frac{1}{2}$ inch; and the whole double bottom space will carry 1000 tons of water-ballast, the additional immersion being 28 inches.

Similar watertight subdivision is carried out in the unarmoured war-ships of the Royal Navy having iron or steel hulls; and to some extent it is applied also in composite ships. The *Iris* steel despatch vessel, for example, is built in sixty-one separate compartments; the *Edgar* class of cruiser in 140 compartments. In foreign war-ships of recent design the same principles have been applied, and in some instances carried even further than in English ships. For instance, the large armoured frigate *Admiral Duperré*, of the French Navy, is said to have nearly two hundred separate compartments; and it would appear that equally minute subdivision has been secured in the large Italian ships *Italia* and *Lepanto*. Nor are unarmoured ships exceptions to the prevalent foreign practice.

In Figs. 22-29 the double-bottom arrangements of war-ships are illustrated. Double bottoms are advantageous (1) as a means of safety, (2) as a source of economy when fitted to carry water-ballast, (3) as an efficient arrangement of the thin materials in the lower part of the structure, enabling them to resist longitudinal strains. The last-mentioned feature is discussed in Chapter IX.; respecting the other two a few remarks may be added. The lower part of any ship is most liable to injury by touching the ground, the thin bottoms of iron or steel ships being peculiarly liable to serious damage. If there be an inner skin, however, and the damage does not extend to it, fracture of the outer skin may be very extensive, but no water will enter the hold. Very many cases are on record, showing the great usefulness of the inner skin; two only will be mentioned. The first is that of the *Great Eastern*, which had a complete double bottom. Off the American coast the vessel ran ashore, and tore a hole 80 feet long in her outer skin, but the inner skin remained intact, and no

water entered the hold. The second is that of her Majesty's ship *Agincourt*, which ran on the Pearl Rock at Gibraltar; this ship has a partial double bottom, and fortunately grounded at a part where the inner skin existed, so that no serious consequences followed.

Considerations of safety and structural strength chiefly influence the adoption of double-bottoms in war-ships: their use as receptacles for water-ballast is unfrequent, although they are generally arranged for such use when required, and often used to carry fresh water for use in the boilers. In merchant ships, however, the chief inducements to use double bottoms have been found in the commercial advantages of water-ballast. Instead of having to incur delays and considerable expense in shipping and discharging rubble-ballast, the commander of a ship fitted for water-ballast can readily admit or discharge such ballast. In some trades the consequent gains are greater than in others, but it is now generally agreed that the balance of advantage is in favour of ships built with improved forms of double bottom. The older forms of water-ballast tanks used before the adoption of the cellular system were objectionable in some respects, raising the cargoes high in the ships, and decreasing the space available for stowage; yet the experience gained with these imperfect arrangements has largely influenced subsequent practice.*

The parts of the inner bottom situated above the bilges in war-ship (see sections in Figs. 25-29) are often termed "wing-passage bulkheads," and are so far inside the outer skin that they can only be broken through by heavy blows on the side. It is at this part that the greatest damage is likely to be done by ramming or torpedo explosions; and the best known remedy against either is undoubtedly internal subdivision. To attempt to keep out either a ram or a torpedo attack is hopeless; the outer skin is certain to be broken through and possibly the inner also. But whereas a grazing blow at low speed would suffice to tear a large hole in the outer skin, only the direct blow of a ram moving at good speed would be likely to penetrate the inner skin of an armoured ship.

An illustration of the usefulness of the wing-passage bulkhead against ramming or collision was afforded in the accidental collision of the *Minotaur* and *Bellerophon*; the outer skin of the *Bellerophon* was broken, and the armour driven in, but the ship remained on service for some time before the repairs were completed. Again, when the *Hercules* and *Northumberland* came into collision, a very similar advantage resulted from the existence of the wing-passage in the latter ship. In the case of the *Vanguard*, although the vessel

* See a valuable paper "On Water-Ballast," by Mr. Martell (chief surveyor to Lloyd's Register), in *Transactions of Institution of Naval Architects* for 1877.

was lost, the existence of the inner skin was an immense advantage to the ship, keeping her afloat for seventy minutes after the collision, whereas, had there been no inner skin, the vessel must have sunk in a very few minutes. So much misapprehension has existed on this matter that it may be well to adduce a few facts in support of the foregoing statement. Fig. 30 shows a cross-section of the *Vanguard*,

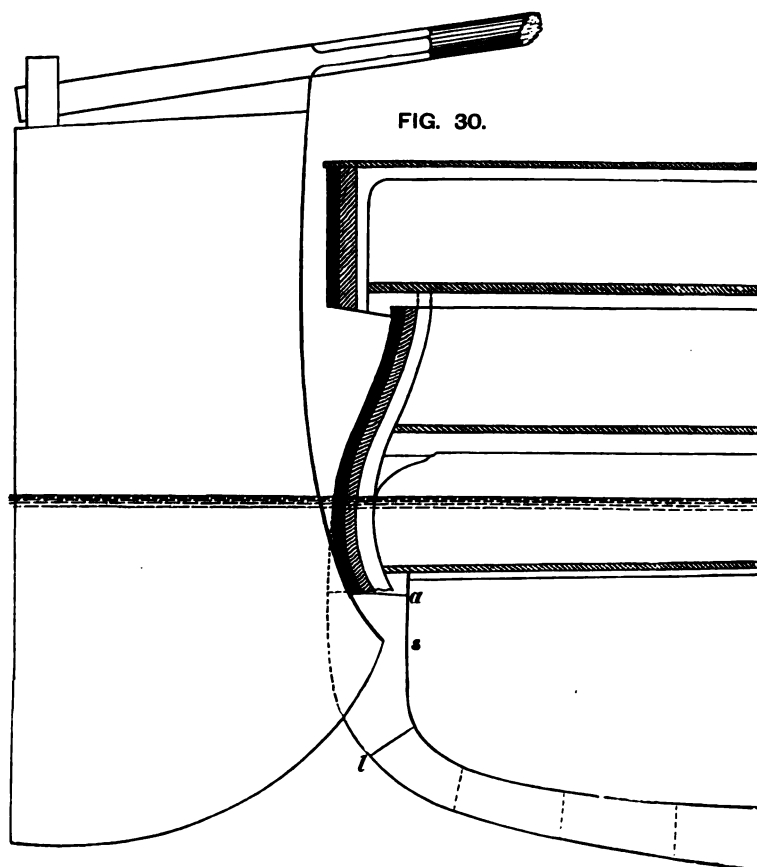

with the bow of the *Iron Duke* in the position which it probably occupied at the time of the collision. It will be noted that, although the armour was driven in, and the armour shelf (*a*) damaged, the inner skin (*s*) was not pierced. This the divers asserted after careful examination, and there is conclusive corroborative evidence that their report is correct. Evidence given before the court-martial proves that at first the vessel sank at the rate of only 8 inches in fifteen minutes, and at last at the rate of 1 inch per minute; this maximum rate of sinking corresponds to a total inflow of only 27 tons of water per minute, which would have been admitted by an

aperture less than *one square foot in area*. But the divers, after measurement, reported that the hole in the outer skin was 10 feet in depth, varying in breadth from 2 feet to 3 feet. Assuming the area to have been 20 square feet (which is probably less than the truth), the initial rate of inflow of water per minute, had there been no inner skin, would probably have been at least 1000 tons, or nearly fortyfold what it actually was at the last. It seems certain, therefore, that the damage to the armour shelf, and other parts of the ship, admitted into the hold in the aggregate no more water than a hole one square foot in area in the skin of an ordinary ship with no double bottom would have admitted, notwithstanding the fact that the *Iron Duke* struck the *Vanguard* a blow much exceeding in force that delivered by the projectile of a 35-ton muzzle-loading gun. It is noteworthy also (see Fig. 30, and the sections in Figs 25-29), that in the *Vanguard* the inner skin terminated about 4 feet under water, whereas in most of her Majesty's ships it is carried to the main deck, several feet above water—a preferable arrangement. Even her loss supplied, therefore, a most striking example of the utility of watertight subdivision, for she was kept afloat more than an hour by this means, instead of foundering in a very few minutes, as an ordinary iron ship similarly damaged in the outer skin must have done. This case also illustrated the necessity for taking all possible care in maintaining the integrity of bulkheads and other partitions intended to be watertight, as well as for keeping in thorough working order the doors or covers fitted to any apertures cut in bulkheads or platforms for ventilation or for convenient access to compartments in the hold.

The more recent case of the *Grosser Kurfürst* has been treated, by some writers, as a proof of the small value attaching to watertight subdivision. This vessel sank in less than ten minutes after her collision with the *König Wilhelm*, notwithstanding the fact that she was extensively subdivided. The circumstances of her loss are well known. She was proceeding in company with her consorts, with watertight doors open in bulkheads and no precautions taken to provide for rapidly closing the doors, such as would have been taken in action. In the endeavour to cross the bows of the *König Wilhelm*, when a collision seemed imminent, the *Grosser Kurfürst* was driven at nearly full speed; and this rapid motion aggravated greatly the injury consequent upon the entry of the spur of the *König Wilhelm* into her side, the skin-plating being torn away for a considerable distance. The access of water to the hold-space was thus made easy, and the ship sank rapidly. Possibly the damage done might have caused her to founder had all possible precautions been taken—doors closed and all watertight partitions secured. But it is clearly

unfair to omit consideration of the exceptional circumstances above-mentioned, or to depreciate the value of watertight subdivision because the *Vanguard* and *Grosser Kurfürst* were sunk. On the other side, numerous cases can be mentioned in which ships, which would otherwise have foundered, have been kept afloat by their watertight bulkheads.

It cannot be claimed for the most minutely subdivided war-ship that she is absolutely unsinkable. Comparatively large spaces have to be provided for engines, boilers, and equipment; and this puts a practical limit on the minuteness of watertight subdivision. Moreover, the damage inflicted by ramming or torpedo attacks may be so extensive as to throw several compartments open to the sea simultaneously. On the other hand, the chances of escape are obviously increased, as the subdivision is made more thorough. If the primary consideration in the design of a ship were to make her as nearly as possible unsinkable, it would clearly be desirable to associate extensive subdivision into watertight compartments with the use of cork, or other packing materials of small specific gravity. By this means, if there were no limitations of size or cost, it might be possible to produce a vessel which could sustain a very considerable amount of damage before it ceased to be buoyant. The internal spaces to which water could find access would, in the aggregate, bear a small proportion to the reserve of buoyancy; and when damaged the condition of the vessel would resemble that of a water-logged timber-laden ship. The drawbacks to this system are great; size, cost, and propulsive power would all require great increase, and it is scarcely probable that the plan will ever find favour, except on a limited scale. The system is applied, to some extent, in lifeboats, and to certain limited portions in special classes of war-ships, wherein the whole or a portion of the length is protected by a strong deck. For example, in the *Inflexible* and other "central-citadel" ships of the Royal Navy, cork packing and extensive watertight subdivision are adopted before and abaft the citadel and above the under-water armour deck. Similar methods have been used in vessels designed for torpedo service in foreign navies. In the Italian ships *Italia* and *Lepanto*, which are protected below water by strong decks, extremely minute watertight subdivision of the water-line region above those decks is trusted to preserve the buoyancy and stability. In some protected cruisers, water-excluding materials (cork, cellulose, etc.), have been fitted along the sides in the region of the water-line for the purpose of maintaining buoyancy and stability, or assisting in stopping the inflow of water through shot-holes. Suggestions have also been made to construct horizontal decks at a moderate distance under water, and to attach to the upper surfaces

a considerable thickness of light buoyant material. As a rule, however, such special arrangements for excluding water are not adopted in warships. In the *Polyphemus* of the Royal Navy, a different system is applied; the hold-space is very minutely subdivided, and any loss of buoyancy which may occur in action can be met, either wholly or partially, by letting go iron ballast carried for that purpose. The reserve of buoyancy in this vessel is small, if measured in the manner described on p. 9; but the detachable ballast represents a further reserve of about 10 per cent. of the displacement.

Watertight Subdivision in Merchant Ships.—The principles of watertight subdivision above described apply to merchant ships as well as to war-ships. In merchant ships, however, facilities for the stowage and working of cargoes as a rule exercise great influence upon the extent to which subdivision is adopted. Except in passenger steamers carrying relatively small cargoes, it is usually considered that spacious, easily accessible holds, are essential to successful working. Consequently the increase of safety admittedly attainable by the multiplication of watertight partitions has been subordinated in most iron and steel cargo-carriers to considerations of stowage. In certain special trades, for many years past, extensive subdivision has been practised. It has been maintained also by some authorities that in general trades the subdivision of holds does not prejudicially affect commercial success; but the balance of opinion lies, at present, on the opposite side. The value of watertight subdivision has, however, been increasingly recognised of late in merchant-ship construction. Various causes have contributed to this result. One which deserves mention is the action taken by the Admiralty from 1875 to 1886 in forming an official list of merchant steamers suitable for state purposes, and making a certain degree of subdivision essential to entry on that list. The condition laid down was that every ship should be so divided as to remain afloat in moderate weather with any *one compartment* thrown open to the sea; proper allowance being made for the space occupied by cargo, and for the load-draught of the ship. At first this very moderate condition was not fulfilled in many vessels. By modifications in existing ships and improved arrangements in new ships, the number of vessels qualified for admission became very large, including many cargo-carriers. Passenger-steamers were readily brought into the qualified class, and in a large proportion of the largest and swiftest vessels on the Admiralty list, the extent of subdivision suffices to keep them afloat with any *two compartments* thrown open to the sea. Since 1887 the earlier official list has not been continued, the Admiralty having instituted a system of sub-

vention for the largest and swiftest mail steamers, with a view to their employment as auxiliary armed cruisers. The condition of efficient subdivision remains in force.

For merchant ships generally there is no legal enforcement of watertight subdivision with iron or steel hulls. Prior to 1862 there were legal conditions. All iron steamers were required to have watertight bulkheads enclosing the engine-rooms; in other words, two bulkheads were essential. In 1854 it was provided that these two bulkheads should be made to divide ships into three parts, approximately equal to one another, or as nearly so as possible. A small watertight compartment was also made essential at the after end of the shaft in screw steamers. For passenger steamers at the present time, Board-of-Trade surveyors are instructed to insist on a collision bulkhead forward, an after watertight compartment in screw steamers, and the watertightness of the shaft tunnels. If more bulkheads are fitted, their condition and that of any watertight doors has to be ascertained. The officials of the Board of Trade have been strong supporters of the view that efficient watertight subdivision is of supreme value as a means of saving life and property at sea.* The department has, however, hitherto maintained the position that shipowners should deal with this matter independently, or nearly so, of legal or official restrictions.

The registration societies, while encouraging subdivision, and recording in their registers the number of bulkheads actually fitted in ships, have not insisted on the maintenance of flotation with any specified number of compartments thrown open to the sea. Lloyd's rules at present provide that all ships shall have a collision bulkhead near the bow. This is the only bulkhead required by the rules in iron or steel sailing ships. In all steamers the machinery-space has to be enclosed by bulkheads; and a fourth bulkhead has to be built at a reasonable distance from the stern. In steamers 280 feet in length and above, the fore-hold has to be further subdivided by another bulkhead; and for lengths of 330 feet and above, the after hold has to be similarly subdivided. Regulations are also laid down for the heights to which the bulkheads must be carried, and for their structural arrangements. These rules are obviously framed with reference to the provision of roomy holds, facilitating the stowage and working of cargo. The rules of the Bureau Veritas give 90 feet as the length of hold it is undesirable to exceed in any one compartment, except in vessels built to carry special cargoes of unusual length. They also recommend, but do not make obligatory,

* See *inter alia*, the Report of Evidence taken by a Parliamentary Committee on Saving Life at Sea, C. 249, 1887.

such a spacing of bulkheads as would enable ships to keep afloat with any one hold flooded.

The Council of the Institution of Naval Architects, in 1867, proposed, as a standard of efficient subdivision for merchant ships, that they should be able to keep afloat with any two compartments laid open to the sea. The Committee of 1889 on Life-Saving Appliances endorsed this standard for the highest class of ships; and so did the Committee on Bulkheads appointed by the Board of Trade, whose report was presented to Parliament in 1891.* Although this subdivision goes far beyond common practice, it is much inferior to that of war-ships, in which from three to six of the largest compartments may be filled simultaneously without bringing the tops of the bulkheads under water, or allowing water to pass into compartments adjacent to those filled.

The inquiry of the Bulkheads Committee (1890-91) is the most important step taken since iron and steel merchant ships came into use, with a view to placing on a sound and scientific basis the important questions of "the spacing and construction of watertight bulkheads in ships of the mercantile marine." The committee had regard to the exigencies of trade in various classes of ships, as well as to the provision of safety from foundering. They reported that a careful classification of ships was necessary; and a graduated system of subdivision in ships of different sizes and types. The highest standard of subdivision—flotation with two compartments bilged—they reserved for first-class ocean passenger steamers not less than 425 feet in length, and cross-channel passenger steamers. Passenger steamers from 350 feet to 425 feet in length they considered should be made capable of floating in moderate weather, with any *two* adjoining *fore-body* compartments, or any *one after-body* compartment, in free communication with the sea. Passenger steamers 300 to 350 feet in length should keep afloat with any two of the three foremost compartments, or with any one of the other compartments, in free communication with the sea. For passenger steamers less than 300 feet in length, and for sailing ships irrespective of length, carrying more than one passenger per 33 tons of registered tonnage, the subdivision recommended is identical with the preceding grade; except that the two foremost compartments are named instead of any two of the three foremost compartments. Cargo-steamers and sailing ships are still more leniently treated. The old Admiralty condition of floating with any one compartment bilged is recommended for steamers not less than 300 feet, and sailing ships not less than 275 feet, in length. For

* See Parliamentary Papers, C. 5762-89; C. 6405-91.

smaller vessels, any one compartment *in the fore-body* is substituted for any one compartment.

Omitting the last grade, including cargo-steamers from 260 to 300 feet in length, and sailing ships from 225 to 275 feet in length, the committee's recommendations, therefore, take as a minimum of subdivision the old Admiralty condition, and rise by easy stages to the condition of floating with any two compartments bilged. In other words, they confirm the view that, except in the smallest classes of ocean-going cargo-carriers, the requirements of trade are not hampered unduly by the condition that ships shall be made capable of keeping afloat with any one compartment bilged; whereas in passenger-steamers of the highest class twice that degree of subdivision is considered reasonable.

These conclusions and recommendations cannot but have great weight on future practice, even if they receive no legal sanction. They indicate a considerable advance in the appreciation of the importance of subdivision amongst shipowners. Furthermore, they emphasise a principle often previously enunciated, viz. that it is proper to make fuller provision for safety in vessels carrying passengers than can be accepted in cargo-carriers. Exception may be taken to details in the scheme proposed by the committee, but its main features will doubtless eventually command general approval. A powerful incentive to more extensive subdivision is now to be found in the fact that the Board of Trade permits a very great reduction in the outfit of boats and life-saving appliances in well-subdivided vessels, as compared with what is required (under the Life-Saving Appliances Act of 1889) in iron or steel vessels of ordinary construction.

From what has been said on p. 13, it will be obvious that the legislation of 1890 on the load-line question, fixing a maximum draught for every British merchant vessel above 80 tons, will enable the subject of spacing bulkheads to be dealt with in a more exact fashion. This spacing also requires some assumption to be made as to the densities of cargoes carried, and the spaces occupied by them, when a ship is floating at her load-line. On successive voyages a cargo-steamer, for example, may carry widely differing cargoes. After full consideration, the Committee on Bulkheads recommended that coal, occupying 47 cubic feet per ton, should be taken as the standard cargo, and they assumed that with such a cargo water could find access to 40 per cent. of the hold-space occupied by the coal. The committee further pointed out that if bulkheads were so closely spaced as to provide for keeping ships afloat with very heavy cargoes, such as iron, the holds would be made too short for general trade. Tables are given in the Appendix to the Report, enabling the bulk-

head spacing to be determined approximately in various classes of ships, so as to fulfil the conditions laid down. These tables are likely to be of much assistance to designers of merchant ships; but the process of direct calculation is very simple, and is already frequently applied in determining the positions of bulkheads, so as to estimate "sinkage" or "change of trim," with cargoes of different densities in the holds, when selected compartments are assumed to be laid open to the sea.

In merchant ships transverse watertight bulkheads naturally form the most convenient partitions. Deck-plating also, in many instances, is made to assist subdivision, particularly where necessities for accommodation in passenger-steamers cause the upper portion of a bulkhead to be carried up at some distance before or abaft the lower portion. Shaft-tunnels in screw steamers are always formed into watertight compartments. Longitudinal bulkheads are not common. They are fitted in the engine-room of some of the largest twin-screw steamers. Cellular double bottoms are very largely adopted, primarily for water-ballast, although they add greatly to safety. As a rule this cellular construction ceases at the bilges. In some cases, however, coal-bunkers are formed at the sides of boiler-rooms, and the bulkheads made watertight. There is not the same definite assignment of hold-spaces for purposes of stowage in merchant ships as in war-ships; consequently the formation of subsidiary compartments in the hold—corresponding to the magazines, shell-rooms, store-rooms, etc., of a war-ship—is not possible in merchant ships. Outside the machinery and boiler compartments, the only subdivision of the hold is usually effected by transverse bulkheads, the intermediate spaces being kept free for stowage of cargo.

This circumstance makes the provision of adequate strength in the bulkheads of merchant ships a matter of greater difficulty than the corresponding provision in war-ships, where the transverse bulkheads are succoured and supported by longitudinal bulkheads, platforms, decks, etc., abutting against them or carried through them. It is essential to effective subdivision that all partitions, in all classes of ships, shall be sufficiently strong to bear the stresses brought upon them when compartments are in free communication with the sea. The Bulkhead Committee deal with this branch of the subject very thoroughly.

Efficiency of subdivision also requires, as above mentioned, that all watertight doors or covers in partitions shall be kept in good order and be perfectly under control. Many trials have been made of plans for dispensing with such doors low down in ships, and maintaining the integrity of bulkheads. Experience has been adverse, however, to this method. In ships originally so constructed

doors have subsequently been formed, the requirements of supervision and ready communication in the engine and boiler rooms having necessitated this change. The drill in war-ships makes the rapid closing of watertight doors in case of accident or emergency a practical certainty; similar arrangements in merchant ships are obviously desirable, and are recommended by the Bulkhead Committee.

CHAPTER II.

THE TONNAGE OF SHIPS.*

AT a very early period the necessity must have been felt for some mode of measuring the sizes of ships, either for purposes of comparison, or for estimating the cost of construction, or for determining the carrying capacity, or for computing the various dues and duties from time immemorial levied upon shipping. In some ancient documents statements occur of the "tonnage," or "portage," of ships; but it is not possible to settle how this tonnage was calculated. The term "tonnage" probably originated in connection with dues levied on ships carrying wine in casks, or "tuns"; these dues being regulated by the number of tuns carried, and the sizes of ships being roughly measured by the number of tun-casks which could be stowed in their holds. In the fifteenth century, the tun had become a fixed measure of capacity, and the subject of legislation in this country; and it is interesting to note that in France also the earliest tonnage measurements were similarly connected with the stowage of wine-casks.

By an Act of Parliament of 1423, a tun of wine was not to measure less than 252 gallons old English measurement; but the standard measures of that early period were not very definitely fixed. At a much later date it is on record that two gallons, each accepted as a standard, were found to differ by as much as 18 per cent. Taking the mean of these, a tun of wine would apparently have roughly approximated in weight to a ton of 2240 lbs. avoirdupois.

* For fuller information, the following works may be consulted, to which we are indebted for many of the facts stated in the text:—

Moorsom's "Laws of Tonnage." London: 1852.

"Observations respecting admeasurement of Tonnage." 1867.

"Tonnage, Past and Present":

Nautical Magazine, 1889-90.

"Instructions to Measuring Surveyors of Board of Trade." 1891.

"Report of Royal Commission on Tonnage": Parliamentary Papers, C. 3074 and C. 3074 I. 1881.

Memoir by M.M. Kiaer and Salvesen: prepared for the International Congress at Christiania. 1876.

When tonnage measurements were first used for fiscal purposes, ships, according to present standards, were little more than large open boats, undecked except for platforms near the stem and stern. The number of tuns of wine that could be stowed in the hold was, roughly, a measure of the *internal capacity*; and the original tonnage was therefore based on *capacity*, and not *dead-weight*. For wine-cargoes, capacity and dead-weight were, however, convertible terms. With many other descriptions of cargo the limit of earnings, and the dues levied, must have been fixed by the maximum dead-weight which could be safely carried. For such cargoes the dues, reckoned by weight, were known as "poundage."

Some approximate but recognised system of expressing the sizes of ships in tuns clearly existed before any legal enactments of methods of measurement for fiscal purposes. Until 1694 no Act of Parliament enforced a rule for tonnage measurement on English ships, with the exception of "keels" and vessels loading coals on the Tyne and Wear. Yet in statements relating to naval forces, to taxation, and to trade, dating many centuries before the Tonnage Act of 1694, tonnage statistics appear. These early tonnages were probably only rough approximations made in terms of the principal dimensions of the ships, and not according to any established rule. They were usually stated in "round figures"; and for the earlier ships of the Royal Navy, considerable discrepancies appear between the nominal tonnage given for the same ship in different documents.

Legal Tonnage of Coal-carrying Vessels.—The earliest English tonnage law was passed in 1422, and applied exclusively to "keels" used in carrying coals at Newcastle-on-Tyne. Its object was to measure accurately the "portage" of each keel, and to mark that portage on the vessel, so that the king's due of "two pence" per chaldron might be secured. The "chaldron" was a measure of capacity, or "heap measure," and not of weight. With coal-cargoes the two modes of measurement, of course, were convertible; and with the stipulated number of chaldrons on board, any keel would float at a certain draught of water, which could be marked on the stem or sternpost. In 1679 another Act was passed, applying the law to the Wear as well as the Tyne, and in 1694 dead-weight was substituted for chaldron-measure. Actual weights of iron or lead were then directed to be put on board each keel, 26½ tons being the maximum load permitted; and the load water-line corresponding was marked with nails on the stem, stern, and each side amidships. An Act of 1775 extended this law to vessels used in loading coal in all ports of the United Kingdom, the vessels coming under the law being limited to harbour or river service, and fairly described as barges rather than seagoing ships.

Early Rules for estimating Tonnage.—Apart from legislation, and by gradations of which no sufficient record remains, the necessities of shipowners and shipbuilders led to the gradual acceptance of rules for estimating tonnage in terms of the principal dimensions of ships. Early in the seventeenth century such rules are known to have been in use, and to have been intended to express approximately the *maximum dead-weight* of the cargoes which could be carried. In 1694 the first Act of Parliament embodying such a rule for English seagoing and coasting ships was passed, but repealed in 1696. It ran as follows:—

L=length of keel (so much as she treads on the ground).

B=breadth amidships (inboard from plank to plank).

D=depth of hold (from plank below keelson to under part of plank of upper deck up to which cargo is stowed).

$$\text{Tonnage} = \frac{L \times B \times D}{94}$$

This rule was known to be approximate only, and instructed writers of the period remarked that the displacement of a ship between her light and load lines could be estimated, and would give the true “dead-weight capability.”

Another Act, passed in 1719-20, was intended to prevent smuggling of spirits in small vessels of “thirty tons’ burthen and under”; and contained a rule for estimating tonnage which differed from that of 1694 chiefly in substituting half the breadth for the measured depth of hold. This assumption of the ratio of depth to beam was probably fairly accurate at the time, but it eventually led to very evil results, which are indicated hereafter.

Builder’s Old Measurement Tonnage.—The next English tonnage law, enacted in 1773, applied to all classes of merchant ships. It continued in force until 1835, and its employment by shipbuilders for their own purposes was common long after it ceased to have legal sanction, while it remained in use as the official mode of measurement for ships of the Royal Navy until 1872. This mode of estimating tonnage is known as “Builder’s Old Measurement” (B.O.M.), and closely resembled the rules embodied in the two preceding Acts, being, like them, intended to express approximately the *dead-weight capability* of ships, that being the basis of tonnage universally regarded as the fairest when the law was passed. Up to that time, also, there is reason to believe that the intention was fairly well fulfilled; but subsequently it was the object of shipbuilders and shipowners to increase, as much as possible, the ratio of the dead-weight capability to the legal tonnage, and the empirical

character of the rule made this an easy matter. The rule may be briefly stated as follows:—

(a) The *length* was taken on a straight line along the rabbet of the keel of the ship from the back of the main sternpost to a perpendicular line from the fore part of the main stem, under the bowsprit. Fig. 31 shows this; CA is the perpendicular line, and

FIG. 31.

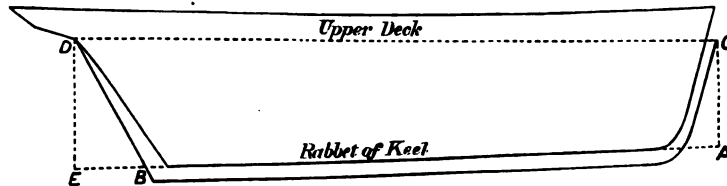

AB is the length required. If the ship was afloat when the measurements for tonnage were made, the length AB could not be taken; and to allow for the rake of the sternpost (BE), and the consequent shortening of the keel, as compared with the length along the deck or water-line, a reduction was permitted (by an Act passed in 1786) of 3 inches for every foot of draught of water from the length measured along the water-line from the perpendicular line AC to the back of the sternpost. Long after raking sternposts ceased to be used in war-ships, a deduction continued to be made for the "rake" of a post which was upright, in order to secure a small diminution of the tonnage. By an additional Act, passed in 1819, the length of the engine-room was also deducted in ascertaining the length for tonnage of merchant steamers; but no similar deduction was made in steamships of war.

(b) The *breadth* was taken from the outside of the outside plank in the broadest part of the ship, exclusive of any additional thickness of planking or doubling strakes that might be wrought at that part. This reduction from the extreme breadth to obtain the "breadth for tonnage" amounted to 10 or 11 inches in large vessels, decreasing to 3 or 4 inches in small vessels; it expressed the excess in thickness of the "wales," worked in the neighbourhood of the water-line, over the ordinary bottom planking. In iron ships the breadth extreme and breadth for tonnage would usually be identical.

(c) From the length obtained as described in (a) was deducted three-fifths of the breadth for tonnage, the remainder being termed the "length for tonnage." This was multiplied by the breadth, and their product by half the breadth, and dividing by 94, the quotient expressed the tonnage—

In algebraical language, if L = the measured length along the rabbet of keel; B = breadth for tonnage—

$$\begin{aligned} \text{Length for tonnage} &= (L - \frac{3}{8}B); \\ \text{Tonnage B.O.M.} &= \frac{(L - \frac{3}{8}B) \times B \times \frac{B}{2}}{94} \end{aligned}$$

As an example, take a ship for which $L=200$ feet, $B=50$ feet ;

$$\begin{aligned} \text{Tonnage B.O.M.} &= \frac{(200 - \frac{3}{8} \times 50) \times 50 \times \frac{50}{2}}{94} \\ &= \frac{170 \times 50 \times 25}{94} = 2260\frac{60}{94} \text{ tons.} \end{aligned}$$

The continued product in the numerator expresses capacity ; and it is probable, as remarked above, that the divisor 94 was chosen with reference to the carrying power of the ships in tons of dead-weight. The following explanation has been suggested as to the choice of the divisor. In the older classes of sailing ships the length was commonly about four times the breadth ; consequently the "length for tonnage" was about 3·4 times the breadth. The mean draught was about one-half the breadth ; and the coefficient of fineness for displacement (see p. 4) was about *one-half*. Hence it followed that the displacement in cubic feet was not very different from the product—

$$\cdot 5 \times \text{length} \times \text{breadth} \times \cdot 5 \text{ breadth} ;$$

Introducing the value for the length for tonnage stated above, this expression was supposed to resolve itself finally into the approximate equation—

$$\begin{aligned} \text{Displacement (in cubic feet)} &= \frac{62}{100} \times \text{length for tonnage} \\ &\quad \times \text{breadth} \times \frac{\text{breadth}}{2} \end{aligned}$$

$$\begin{aligned} \therefore \text{Displacement in tons} &= \frac{62}{3200} \times \text{length for tonnage} \\ &\quad \times \text{breadth} \times \frac{\text{breadth}}{2} \end{aligned}$$

The hulls of these vessels are said to have weighed about 40 per cent. of the displacement, 60 per cent. representing the carrying power. Hence—

$$\begin{aligned} \left. \begin{array}{l} \text{Approximate carrying power} \\ \text{(in tons, dead-weight)} \end{array} \right\} &= \frac{3}{8} \times \frac{62}{3200} \times \text{length for tonnage} \\ &\quad \times \text{breadth} \times \frac{\text{breadth}}{2} \\ &= \frac{1}{84} \times \text{length for tonnage} \\ &\quad \times \text{breadth} \times \frac{\text{breadth}}{2} \end{aligned}$$

which agrees with the B.O.M. rule. This investigation will be seen

to proceed upon certain fixed proportions of breadth to length and draught, as well as of weight of hull to displacement. Departures from these proportions rendered the rule useless as a measure of carrying power, and it was evaded when its legal enactment supplied a motive for so doing. In order to produce vessels of small nominal tonnage but great carrying power, raking sternposts and other small devices were employed; but the adoption of great depth, in association with very full forms under water, was most influential. Instead of the depth of hold being 50 per cent. of the breadth, it was increased to 70 or 75 per cent. in many cases; and such full forms were adopted that the dead-weight capability ordinarily exceeded the tonnage by one-third. These deep heavy-laden "box-shaped" vessels were, of course, far inferior to vessels of good proportions as regards speed, safety, and good behaviour at sea. The numerous disasters which resulted, and the obvious inferiority of British to foreign merchant ships, being distinctly traceable to the bad influence of the tonnage law, led to an agitation for its repeal.

Tonnage Legislation and Enquiries, 1821-53.—An Admiralty committee investigated the subject in 1821, and reaffirmed the principle that dead-weight capability was the fairest basis for tonnage. They clearly understood that this could be exactly determined for any ship if the light and load lines were fixed; but they reported that it was impossible "to ascertain the position of these lines in a "satisfactory manner," and suggested the estimate of dead-weight capability by means of an approximate rule, based on a few internal measurements. This rule would have been easily evaded, and was not adopted. A second commission was appointed in 1833, and reported in favour of "internal capacity as the fairest standard of "measurement, including all those parts of a vessel which, being "under cover of permanent decks, are available for stowage." Great opposition was raised to any change in the law; but finally, in 1835, another tonnage law was enacted known as the New Measurement, in general accordance with the recommendations of the commission.

The change of basis from dead-weight to internal capacity thus made was a step of the highest importance, having been accepted in all subsequent legislation. It will be seen, from the explanations given above, to have been a reversion to the earliest system of estimating the sizes and earnings of ships. All English tonnage laws from 1694 to 1836 had been designed to approximate to dead-weight capability, but at a very early date French laws had based tonnage on internal capacity. The *Ordonnance de la Marine* of 1681 fixed 42 cubic feet of internal space, as 1 ton of tonnage; this unit corresponding to the space required for the stowage of four wine-casks. In finding the internal volume three

cross-sections were taken in the ships; the areas of these sections were estimated roughly, and a mean area found, which, multiplied by length, and divided by forty-two, gave the tonnage. The process was rough, and it appears that here also the final result gave a tonnage fairly approximating to the dead-weight capability of the ships to which the rule applied when it was framed. Bouguer, with his usual discrimination, pointed out the weak points of this system, and proposed improved methods, anticipating by his suggestions (made in 1746) most of the proposals for tonnage measurements since made. If internal capacity was to be the basis of tonnage, he proposed to make the measurements in a strictly scientific manner, much as is done under the Moorsom system now in use; and, if dead-weight capability was to be used, he proposed to determine it by estimating the displacement between the light and load-lines. For port dues he proposed to take the volume of the parallelepipedon circumscribing the ship, since that practically measured the space she occupied.*

The "New Measurement" was the legal tonnage for British merchant ships from 1836 to 1854. The rules for estimating internal capacity were intended to give a fair approximation to the volume of "all those parts of a vessel which, being under cover of permanent decks, are available for stowage," on the basis of the smallest number of measurements which would yield trustworthy results. Taking a considerable number of ships as examples, it was arranged that their aggregate tonnage should be about the same under the old and new systems, by selecting an appropriate division for use in the new measurement. For steam-ships, the estimated cubic contents of the part between the engine-room bulkheads divided by 92·4 gave the deduction allowed from the gross tonnage. It is unnecessary to reproduce the rules for this measurement, but it may be stated that they involved the measurement of certain lengths, breadths, and depths in a few specified positions, and were, consequently, open to evasion. By means of various devices, shipbuilders were able to secure a considerable excess in the true capacity over the nominal capacity, amounting to as much as 15 per cent. in some cases. Mr. Moorsom summed up his review of the operation of this law as follows: "Although it has suppressed the premium hitherto given to the building of short, deep ships, and although great improvements in our commercial navy have accrued under it, yet as it offers so many facilities for evasion, and is not, from the very nature of its constitution, to be depended on generally in its results, it cannot be expected to possess either the confidence or approbation of the

* See the *Traité du Navire*.

“public.” A third commission on tonnage was appointed in 1849, and it recommended that the “entire cubic contents of all vessels “externally” should be carefully measured, and made the basis of dock, light, harbour, and other dues. Poops, forecastles, and other covered-in spaces were also to be measured and included in the tonnage. The total volume in cubic feet was to be divided by 35, and 27 per cent. of the quotient was to be the register tonnage of sailing vessels. In steamers the tonnage due to the engine-room was to be deducted; this was to be done because corresponding deductions had been made in preceding laws, but the commission expressed a doubt as to the propriety of making any such deduction. This proposal was not adopted, and it is mentioned here chiefly because it has been many times repeated since it was first made.

The principal objection urged to this system of external measurement was, that the fairest measure of the earnings of a ship was to be found in her *internal capacity*, as affirmed by the commission of 1833. This view received the support of leading shipowners, whose views were pithily expressed by Mr. Moorsom in the following passages: “It is alleged,” he writes, “that light merchandise “(meaning thereby such merchandise as fills the hull of the vessel “without wholly loading her to the load-draught of water) forms the “predominant cargoes of commerce, and constitutes for the most part “the profits of the ship; and, therefore, it is maintained that the “internal capacity, on which the stowage of this merchandise entirely “depends, must be the fair and proper basis for assessment. Besides, “the poops, spar-decks, etc., which are appropriated entirely to “passenger traffic, frequently form a large item in the profits of the “ship.” Again he says, “Having assumed, as affirmed to be the case “by the generality of shipowners, . . . that the profits of a vessel “are, for the most part, directly dependent on the quantity of space “for the stowage of cargo and accommodation of passengers—having “assumed this as an incontrovertible condition of the question—all “further investigation of the subject has gone to prove the superior “eligibility and desirableness of internal measurement.”

Tonnage Law of 1854 (Moorsom System), and its Amendments.—The rules for tonnage measurement devised by Mr. Moorsom and embodied in the Merchant Shipping Act of 1854, were intended to give a practically correct estimate of the internal cubic capacity of vessels under their upper decks, and of the “permanent closed-in “spaces on the upper decks available for cargo or stores, or for the “berthing or accommodation of passengers or crew.” Mr. Moorsom had been trained in the Admiralty School of Naval Architecture, and his rules, while simple in character and involving only a moderate amount of labour, rest upon scientific principles of

mensuration, and make evasion difficult. They have now been in use for nearly forty years, and have been accepted, with certain modifications in detail, by all the maritime nations of the world, as well as for international purposes on the Danube and the Suez Canal. A Royal Commission in 1881, after reviewing the working of the Act of 1854, almost unanimously recorded the opinion that the Moorsom system of tonnage had been favourable to the progress of merchant shipping, and was preferable to any other system that had been tried or suggested. Certain modifications were recommended by the commission in matters of detail, and in regard to deductions from gross tonnage; to some of these reference is made hereafter. In the main, however, the Moorsom system of measurement is almost universally approved as having practically fulfilled the intentions of its framer.

This is the more remarkable when it is remembered that in 1854 iron shipbuilding was in its earlier stages, and that steam propulsion for seagoing vessels was but little developed. Since that date there have been remarkable changes and improvements in the sizes, speeds, types, and structures of merchant ships; and there has been a great advance in scientific knowledge on the part of persons engaged in shipbuilding. Under these circumstances, it was inevitable that differences of opinion should from time to time arise in the interpretation of the rules. The technical terms in the Act of 1854 related to wood ships such as were then chiefly built; and the rules were devised for vessels of moderate size and simple types as compared with present practice. There have been appeals to the law courts in typical cases, and decisions as to the applications of the rules which have been much discussed. Exception has been taken to the deductions made on account of propelling machinery in steamers, and many proposals have been submitted to Parliament for amendment. In the main, however, the Act of 1854 still stands, and the amending Acts of 1867, 1876, and 1889 only deal with a few points of importance that have arisen in working the original Act.

Details of the rules for estimating internal capacity cannot be given here. A brief summary of the principal steps must suffice. Moorsom arranged to calculate separately: (*a*) Capacity under the "tonnage" deck; (*b*) capacity of space (if any) between the tonnage deck and the upper deck; (*c*) capacity of all "permanent closed-in" spaces on upper deck available for cargo or stores, or for the "berthing or accommodation of passengers or crew." The sum of these capacities in cubic feet, divided by 100, expressed the "gross tonnage." A ton of Moorsom tonnage is 100 cubic feet, or 2·83 cubic metres. The divisor 100 was chosen because of its con-

venience, and because it was found to give a close approximation to the tonnages of a number of ships under both the preceding law and the new law.

The "tonnage" deck was defined as the upper deck in ships of less than three decks, and the second deck from below in all other ships. Most of the ships of 1854 had no more than two decks. The conditions are entirely different in large ships now built. Moorsom's rules for under-deck tonnage closely resemble those adopted by naval architects in calculating the volume of displacement for a ship. Actual half-breadth measurements are taken by the surveyors of the Board of Trade, at specified positions in the interior of the ship, if that is accessible. The longitudinal and the vertical intervals between these measurements are varied with the length and depth of the ship, the intention being to space them sufficiently close to indicate fairly the true shape of the interior, and to prevent evasions of the law by any local thickening of the inside lining or other devices. Having obtained these measurements, the first step in the calculation is to find the areas of a series of equidistant vertical transverse sections of the hold-space below the tonnage-deck; and, secondly, to use these areas in estimating the volume of hold-space.

When the Act of 1854 was framed, ships were of moderate dimensions and simple construction. The developments which have since taken place could not have been foreseen, but it was provided that the department administering the Act should have power "to make such modifications and alterations as may from time to time become necessary in the tonnage rules, . . . in order to the more accurate and uniform application thereof, and the effectual carrying out of the principle of admeasurement therein adopted." This was undoubtedly a wise provision, since a close approach to the true internal capacity ought to be secured, and stereotyped methods of calculation might introduce difficulties or favour evasion. The competent officials of the Tonnage Department under the Board of Trade, whose duty it is to closely scrutinize the working of the rules, appear to have satisfied themselves that no wide departures from Moorsom's methods were necessary. Until March, 1890, those methods remained unaltered. Amended rules were then issued for securing greater accuracy in the computation of the transverse sectional areas in tonnage measurements, and for separately calculating the volumes of subdivisions of the hold when "break or breaks" occur "in a double bottom for water-ballast." In other respects Moorsom's rules still hold good. He provided that in ships of "225 feet and above" only *thirteen* equidistant transverse sectional areas should be measured. No more are

measured now, even in ships 600 feet long, unless there is a break in the double bottom. It has been urged that more transverse sections should be measured in ships of great length. Several foreign nations have acted on this view, and made from 16 to 20 intervals obligatory in long ships instead of 12. No doubt this closer spacing of measured sections gives somewhat greater accuracy; but the fact that the Board of Trade officials have not insisted on the change indicates that it has no great relative importance, as the subject has been carefully investigated.

Many disputes have occurred respecting the fair assessment of under-deck tonnage in ships fitted for water-ballast. The matter occupied the attention of the Royal Commission of 1881, which made a recommendation thereon. By the Act of 1889 the question has been settled, in a sense contrary to that recommendation, but apparently in agreement with the spirit of the Act of 1854. The law now provides that "in the case of a ship constructed with a double bottom for water-ballast, if the space between the inner and outer plating thereof, is certified by a surveyor appointed by the Board of Trade to be not available for the carriage of cargo, stores, or fuel, then the depth . . . shall be taken to be the upper side of the inner plating of the double bottom." In other words, the volume of the ballast-tank is not included in the under-deck tonnage; and shipbuilders are left free to choose their methods of constructing the hulls for water-ballast purposes.

The estimate for capacity of spaces between the tonnage deck and the upper deck ('tween-deck tonnage) is a very simple matter, requiring no description. Differences of opinion have arisen, however, as to which was the *upper* deck in certain types, and a definite decision on the point was given by the House of Lords in 1875: "the kind of upper or spar deck mentioned in the Act of Parliament is a continuous deck from stem to stern, fastened up and water-tight, sealing up the cylinder formed between the two decks, and making it a fit place for the stowage of cargo like a hold." Before the commission of 1881, evidence was given that this decision bore hardly on "awning-decked" ships (Fig. 12, p. 15), in which a light covering-deck is built all fore-and-aft, and carried by light bulwarks extending down to the true upper deck. Such vessels are not loaded so deeply in relation to their total depth as would be done if the full scantlings were carried to the uppermost deck. It is asserted that this arrangement is chiefly favoured because it prevents the lodgment of water on the decks, gives a greater free-board and increased stability, thus adding to the safety as well as the comfort of ships. Further, it is stated that the internal spaces between the awning and upper decks cannot be fully utilized even when the

lightest cargoes are carried. On these grounds it is maintained that the total internal space is not a measure of the earnings in such ships, but unfairly raises their tonnage upon which dues are paid, as compared with the tonnage of ships in which the erections above the upper deck are discontinuous—such as poops, bridge-houses, forecastles, etc. On the other side it is argued that increased comfort and safety ought to result in larger earnings, and that if the spaces are permanently enclosed there can be no effectual guarantee that cargo or passengers will not be carried above the upper deck. The Board of Trade, therefore, have resisted the endeavour to obtain some reduction of the tonnage of the spaces between upper and awning decks, and, the majority of the Royal Commission having supported this action, no change in the law has been made. So long as a space is not permanently closed in, gaps being left in a deck, or openings in the sides, it is not included in the tonnage, even though it may be readily, but temporarily, closed after admeasurement.

The sum of the tonnages under the tonnage deck and in the 'tween decks is commonly termed the "under-deck tonnage," representing the gross tonnage of a ship exclusive of deck-erections. Under the Act of 1854, an approximate rule was given for measuring the gross under-deck tonnage of laden ships or foreign ships entering British ports, in terms of their external dimensions. It runs as follows according to an amendment made in 1858: The length is taken at the upper deck from the fore point of the rabbet of the stem to the after point of the rabbet of the post. The extreme breadth of the ship is also taken, and a chain is passed under her at this place in order to determine the girth of the ship as high up as the upper deck. Then the approximate gross tonnage under the upper deck is estimated by the formulæ—

$$\begin{aligned} (1) \text{ For wood and composite ships . } & \left. \begin{array}{l} \\ \end{array} \right\} = \frac{17}{10000} \left(\frac{\text{girth} + \text{breadth}}{2} \right)^2 \times \text{length.} \\ (2) \text{ For iron ships . } & = \frac{18}{10000} \left(\frac{\text{girth} + \text{breadth}}{2} \right)^2 \times \text{length.} \end{aligned}$$

In the Act of 1854, larger coefficients were given, namely, $\frac{18}{10000}$ for wood ships, and $\frac{21}{10000}$ for iron ships; but enlarged experience led, many years ago, to the substitution of the coefficients still in use. This approximate rule for the gross under-deck tonnage is now but seldom used, for two reasons—First, all new British ships are measured by the more exact method; and, secondly, so many foreign nations, including all the most important mercantile marines, have now adopted the Moorsom system for gross tonnage, that their legal tonnage, inscribed on the certificates of foreign ships, can be accepted.

Other approximate rules have been given for estimating gross under-deck tonnage. Mr. Moorsom proposed the following rules: If L be the inside length on upper deck from plank at bow to plank at stern; B, the inside main breadth from ceiling to ceiling; D, the inside midship depth from upper deck to ceiling at limber-strake: then the gross tonnage under deck may be approximately expressed by the equation—

Tonnage = $L \times B \times D \times \text{a decimal factor} \div 100$, wherein the decimal factor has the following values:—

	Decimal factor.
Sailing ships of usual form7
Steam vessels and clippers {two decked65
{three decked68
Yachts {above sixty tons5
{small vessels45

These factors cannot be regarded as applying to ships of the present day. It may be interesting, therefore, to give another approximate rule for gross under-deck tonnage in the form most useful in making rough estimates of the tonnage in new steam-ships, for which the principal dimensions are known. Let L be the length, at the load-line, from the front of the stem to the back of the stern-post; B, the extreme breadth to the outside of the plating; D, the depth from the top of the upper-deck amidships to the top of the keel: then, if ordinary methods of construction are followed, the following rules hold fairly well for iron or steel steam-ships of modern types:—

Gross tonnage under deck = $L \times B \times D \times \text{decimal factor} \div 100$

Wherein the decimal factor has the following values:—

	Decimal factor.
Passenger steamers of high speed and sailing ships6 to .65
Passenger and cargo steamers7 to .72
Cargo steamers and oil-tank steamers72 to .8

Special structural arrangements may sensibly modify the values of these factors; and it will be understood that they are useful only in rough estimates, not as substitutes for exact calculations of tonnage.

All *deck-erectments* coming under the terms of the Act of 1854 are separately measured, and the sums of their capacities divided by 100 gives the tonnage to be included in the gross tonnage. In this case also *permanent* enclosure is a necessary condition for the measurements, and facilities for temporary enclosure do not bring

erections under the terms of the Act. There have been differences of opinion in many cases between the Board of Trade and shipowners, especially for new types of ships, as to the inclusion or exclusion of particular erections; and there have been instances where two official surveyors have treated sister ships differently as regards erections. Shipowners and shipbuilders naturally desire to obtain the greatest carrying capacity and comfort on the smallest registered tonnage, and consequently ingenious devices and modifications of previous methods are continually being introduced in the upper works of ships. The Royal Commission of 1881 fully considered the matter, and proposed to amend the law of 1854 as follows: "Gross tonnage should be made to include all permanently covered and closed-in spaces above the uppermost deck; and erections, with openings either on deck or coverings or partitions that can readily be closed in, should also be included in the gross tonnage; but the skylights of saloons, booby hatches for the crew, light and air-spaces for the boiler and engine-rooms when situated above the uppermost deck, as well as erections for the purposes of shelter, such as turtle-backs open at one end, and light decks supported on pillars and unenclosed, should not be measured for the purpose of their contents forming part either of the gross or registered tonnage."

The Act of 1889 does not give effect to these recommendations, and leaves the question of deck-erections as before, except in relation to crew-space and the casing above engine-rooms.

As the law now stands, *crew-spaces*, whether situated on deck or not, will be measured, and included in the gross tonnage. Under the Act of 1854, these spaces, if situated on deck, were not included in the gross tonnage, unless they exceeded 5 per cent. of the remaining tonnage, and in case of such excess, the excess only was added to the gross tonnage. Under the Act of 1867, it was provided that if crew-spaces did not fall below 72 cubic feet per man, or 12 square feet of deck area, and were officially approved as regards sanitation, light, and ventilation, as well as kept free from cargo or stores, the total tonnage of the crew-spaces should be deducted from the gross tonnage. Although the clauses in the Act of 1854 were not formally repealed, the Board-of-Trade officials acted as if they were, and from 1867 to 1879 included the crew-spaces on deck in gross tonnage, making the deduction subsequently in accordance with the Act of 1867. This action was challenged in the law courts, and it was decided that the non-repeal of the clauses of 1854 left both Acts in force. Consequently for ten years the curious anomaly existed that, in many ships with crew-spaces on deck, they were not included in the gross tonnages, and yet were deducted therefrom in estimating nett tonnages. The Act of 1889 repealed the clauses of 1854, and

provided that in future, when estimating register tonnage, no deduction shall be allowed in respect of any space, which has not first been included in the measurement of gross tonnage. Certain specified classes of ships are exempt from the application of the Act until 1894, but it is unnecessary to give details of temporary exceptions.

The Act of 1854 remains in force respecting shelters for deck-passengers, in river or coasting steamers, which shelters are exempted from measurement, if approved by the Board of Trade. Hatchways over cargo holds are also measured, and if their total tonnage exceeds one-half per cent. of the remaining gross tonnage, the excess is included in the gross tonnage. As to other casings over engines, etc., explanations are given hereafter.

The foregoing items of tonnage: (1) under "tonnage-deck"; (2) between tonnage and upper decks; and (3) deck-erectments, make up the gross tonnage in the Register of British merchant ships. By the Act of 1876, however, if a ship engaged in the over-sea trade carries cargo in any space on the upper deck which has not been measured into the tonnage under the Act of 1854, the tonnage of the space occupied is to be measured and added to the taxable tonnage. This law aimed at the discouragement of deck-cargoes, and the increase of sea-worthiness. Its effect is to give a possible variation in the taxable tonnage from one voyage to another.

Passing from gross tonnage to the "nett" or "register" tonnage of British merchant ships, a short statement must be made of the deductions from the gross tonnage allowed by the existing law. Many authorities have supported the view that there should be no deductions, and that gross tonnage should be the legal measurement on which dues should be assessed. Mr. Moorsom is said to have favoured this view, only he had to face the fact that deductions had been permitted under earlier laws. The Suez Canal Company attempted at first to levy dues on gross tonnage, but were overruled. The United States also, from 1865 to 1882, used the Moorsom system on a gross tonnage basis, but since the latter date allow deductions similar to those of other nations. Certain dock-dues in this country and abroad are still based on gross tonnage. For fiscal purposes generally the system of deductions is now universally accepted, and its continuance was supported by the weight of evidence given before the Royal Commission of 1881. It may be accepted, therefore, that the system is practically fair in its operation, taken in association with existing methods of charging dock and harbour dues. These methods might be revised, of course, if the tonnage laws were altered; but dockowners do not appear to desire such legislative revision and its accompanying inconveniences.

Deductions for *crew-spaces* are permitted in all ships. The character of these deductions, and the conditions on which they are allowed, have already been explained. From a careful analysis it has been estimated that the actual deduction for crew-space varies from nearly 10 per cent. in small sailing-ships to $3\frac{1}{2}$ per cent. in sailing vessels of 2000 tons gross tonnage; the average deduction being from 4 to 5 per cent. in both sailing ships and steamers.

The Act of 1889 legalizes the following deductions from "the space included in the measurement of the [gross] tonnage":—

- (a) In the case of a ship wholly propelled by sails, any space set apart and used exclusively for the storage of sails.
- (b) In the case of any ship—
 - (1) Any space used exclusively for the accommodation of the master.
 - (2) Any space used exclusively for the working of the helm, the capstan, and the anchor gear, or for keeping the charts, signals, and other instruments of navigation, and boatswain's stores.
 - (3) The space occupied by the donkey-engine and boiler, if connected with the main pumps of the ship.

These deductions are to be allowed subject to the following provisions:—

- (a) The space deducted must be certified by a surveyor appointed by the Board of Trade, as reasonable in extent, and properly and efficiently constructed for the purpose for which it is intended.
- (b) There must be permanently marked in or over every such space a notice stating the purpose to which it is to be applied, and that whilst so applied it is to be deducted from the tonnage of the ship.
- (c) The deduction on account of space for the storage of sails must not exceed $2\frac{1}{2}$ per cent. of the tonnage of the ship.

This legislation is a practical endorsement of the recommendations made by the Royal Commission of 1881, and is generally approved.

The most important deductions made from gross tonnage are those for *spaces occupied by or necessary for the working of the machinery* in steamships. Such allowances have been made by law from 1819 onwards; their justice has been questioned repeatedly, but the principle has been maintained so far, and probably will be adhered to. The Act of 1854 still remains in force, notwithstanding many attempts to amend its provisions. The Commission of 1881 dwelt upon the anomalies of the existing law, and proposed important changes, but no action has been taken to embody their recommenda-

tion in the Act of 1889. The provisions of the Act of 1854 may be briefly summarized. Spaces "solely occupied by and necessary for the proper working of the boilers and machinery" are measured. These spaces include the internal volume of the ship, below the deck forming the "crown" of the engine and boiler-rooms; the casings for engine-hatches, ventilation, funnels, etc., from this crown to the upper deck; and the shaft trunks in screw-steamers. The sum of these volumes in cubic feet, divided by 100, gives the tonnage of the machinery-space. If this tonnage, in screw-steamers, is above 13 per cent. of the gross tonnage and under 20 per cent., the total deduction permitted, for machinery and coal-space, is 32 per cent. of the gross tonnage. In paddle-steamers, if the measured space has a tonnage above 20 per cent. and under 30 per cent. of the gross tonnage, the total deduction permitted is 37 per cent. This is the first, or "percentage," method supposed to be applicable to all ordinary steamers. A second method is applied where the space occupied for the machinery falls below 13 per cent. or above 20 per cent. of the gross tonnage; the space may then be measured (as before), and the total deduction from the gross tonnage is to be 50 per cent. more than the measured space in paddle-steamers, and 75 per cent. in screw-steamers.

Mr. Moorsom explained that the intention of the law of 1854 was to make a fair allowance for the space occupied by propelling machinery and fuel; or unfitted for other purposes, such as stowage of cargo or accommodation of passengers, because of the presence of the propelling machinery. This intention was not realized, and the failure soon became apparent. In 1860 the Board of Customs made a rule for engine-room allowance, which was intended to give effect to the original idea, and to deduct a tonnage representing the actual machinery-space. This rule was applied until 1866, when it was decided by the law courts to have no legal force, and the law of 1854 has since continued in operation. Under it shipowners have every inducement to arrange the machinery-space in the majority of ocean-going screw-steamers, so as to bring it a little above 13 per cent. of the gross tonnage, and to secure the 32 per cent. deduction. Take, for example, two screw-steamers, each of 3000 tons gross, and suppose that in one the machinery-space is $12\frac{2}{3}$ per cent. of the gross tonnage, while in the other it is $13\frac{1}{3}$ per cent. The deductions would be as follows:—

First steamer :		Tons.
Actual machinery-space . . .		380
Add 75 per cent. of ditto . . .		285
		—
Total deduction		<u>665</u>

Second steamer :	Tons.
Actual machinery-space	400
Deduction allowed (32 per cent. of } gross tonnage)	960

That is to say, the shipowner, by increasing the machinery-space 20 tons, and diminishing the cargo-space equally, secures an increase in the deduction from the gross tonnage of 295 tons, and saves largely on the dues paid on nett tonnage.

It has been estimated that in ocean-going cargo-steamers coming under this percentage rule, the actual tonnage-space available for stowage exceeds the space corresponding to the register tonnage by from 10 to 12 per cent.; and the owners of sailing ships, as well as the proprietors of docks, have not failed to complain of these anomalies. No practical result has followed these criticisms; and the Act of 1889 provides that for existing screw-steamers, the present allowance of 32 per cent. for engine-room shall be continued, even in cases where the addition of the crew-spaces on deck to the former gross tonnage, would make the engine-room space less than 13 per cent. of the amended gross tonnage. This allowance, taken with the crew-space deduction above described, gives a register tonnage of about 64 to 65 per cent. of the gross tonnage to the great majority of sea-going screw-steamers built for cargo-carrying.

The second rule for engine-room deductions in the Act of 1854 is also open to serious objection as applied to certain classes of steamships. For steamers making passages of 3000 to 4000 knots between coaling-stations, 75 per cent. of the measured machinery-space is said to be a fair average allowance for the space actually occupied by coals. It will be obvious that if this is true now, it could not have been true when the law was framed, marine engineering having been so greatly developed in the direction of economy in coal-consumption (see Chapter XIV.); and it is also evident that further improvements may sensibly affect the space required for coals or fuel. Passing this difficulty by, however, and accepting the foregoing statement, it will appear that for many steamers employed on coasting or short sea voyages, the coal-space actually required falls much below 50 or 75 per cent. of the machinery-space. In channel or river passenger-steamers of high speed and in tugs the anomaly is greatest. By an interpretation of the Act of 1854, which has been upheld in the law courts, cases have occurred in which the nett tonnage of swift passenger-steamers has been reduced to little more than 22 per cent. of their gross tonnage, and 30 to 40 per cent. is quite a common value. Tugs of considerable gross tonnage, by the application of the same rules, have had *less than no* register tonnage assigned to them, entirely escaping the payment of many dues, although enjoying

the privileges of harbours, rivers, etc., and earning large sums by towing.

It has been estimated by competent authorities that in sea-going screw-steamers, where the measured machinery-space falls below 13 per cent. of the gross tonnage, the nett tonnage averages about 77 per cent. of the gross. In swifter vessels, having machinery-space exceeding 20 per cent. of the gross tonnage, the nett tonnage averages about 57 per cent. In passenger-steamers of the first class and highest speed the corresponding percentage varies from 44 to 54. Individual vessels may, of course, depart considerably from these averages.

Various proposals have been made by the Board of Trade for the purpose of removing these anomalies; and it is but right to add that the officers of that department have consistently endeavoured to improve the law of 1854, while maintaining its fundamental principle in the directions indicated by experience of its working. In 1866 the department issued a circular requesting consideration of a proposal to make the deduction for engine-rooms as follows: To measure the machinery-space, exclusive of bunkers, and to allow $1\frac{1}{2}$ times that space in all paddle-steamers, and $1\frac{3}{4}$ times in all screw-steamers, the total deduction in any case not to exceed 50 per cent. of the gross tonnage, except in tugs. This method was afterwards accepted by the Commissioners for the Danube Navigation, and is usually termed the "Danube Rule."

Again, in 1867, the Board of Trade submitted for consideration a proposal to measure coal-bunkers as well as machinery-space, and to make the total space thus occupied the allowance for engine-room, etc., it being provided that such allowance should not exceed 50 per cent. of the gross tonnage, excepting in tugs. This proposal was embodied in the Merchant Shipping Code of 1871, which was introduced into Parliament, but not proceeded with. It was subsequently adopted in Germany, and is now commonly termed the German Rule. This plan is specially applicable to ships with permanent coal-bunkers; but many cargo-carrying steamers are constructed with shifting coal-bunker bulkheads; the space assigned to the coal varying with the quantity required to be carried for the particular voyage, and the space sometimes included in, and at others excluded from, the bunkers being respectively unavailable or available for cargo-stowage. Since the nett register tonnage cannot be allowed to vary with the coal-space, some modification of the rule would be necessary. The Danube Rule meets such cases.

The majority of the Royal Commission in 1881 reported in favour of a combination of the Danube and German Rules, with certain modifications, as will appear from the following extract: "The deduction for propelling space in steamers should be the actual space

“set apart by the owner at his discretion for the engine and boiler room and permanent bunkers, provided that such space be enclosed, separated from the hold of the ship by permanent bulkheads, and that the bunkers be so constructed that no access can be obtained thereto otherwise than through the ordinary coal-shoots on deck or in the ship's side, or from the openings in the engine-room or stokehold; but that to meet the varying requirements as to fuel of steamers engaged in long voyages, and to encourage ample ventilation to boiler and engine rooms in hot climates, owners of steamers should have the option to claim as deduction for propelling-space the actual contents of engine and boiler space, plus 75 per cent. thereon in the case of screw-steamers and 50 per cent. in the case of paddle-steamers, without restriction as to extent, construction, and use of bunkers, provided always that the deduction for propelling-space shall not exceed 33 per cent. of the gross tonnage of any screw-steamer, and shall not exceed 50 per cent. of the gross tonnage of any paddle-steamer.” It will be remarked that the limit of deduction for screw-steamers is made considerably lower than in the German or Danube Rules, and that clauses are introduced with the intention of preventing cargo from being carried in the permanent bunkers.

The Act of 1889 touches the question of engine-room allowances only in two points. That relating to the retention of 32 per cent. allowance in cargo steamers has been mentioned above; the second amendment deals with a difficulty which has arisen in recent years in connection with casings over the machinery-spaces, and above the level of the upper deck. The Board-of-Trade surveyors, under the Act of 1854, measured the volumes of the cased-in spaces from the crown of the engine and boiler rooms up to the level of the upper deck. They did not measure the continuations of these cased-in spaces situated above the upper deck, or include the corresponding tonnage in the gross; neither did they reckon the corresponding tonnage into the machinery-space when estimating the percentage allowance, under the second rule of 1854. An appeal was made to the law courts, whose decision was that the whole volumes of the cased-in spaces, although not included in the gross tonnage, must be reckoned into the machinery-space; in other words, that the register tonnages, as estimated by the Board of Trade, must be diminished by $1\frac{1}{2}$ times in paddle-steamers and $1\frac{3}{4}$ times in screw-steamers, the tonnage of closed-in spaces above the upper deck not reckoned into the gross tonnage. This blemish in the law is corrected by two clauses in the Act of 1889. The first, already quoted with reference to crew-spaces, provides that in future no deduction shall be allowed in respect of any space which has not first been

included in the measurement of tonnage. The second provision is as follows:—

“In the case of any ship built or measured after the passing of this Act, such portion of the space or spaces above the crown of the engine-room and above the upper deck as is framed in for the machinery, or for the admission of light and air, shall not be included in the measurement of the space occupied by the propelling power, except in pursuance of a request in writing to the Board of Trade by the owner of the ship, and shall not be included in pursuance of such request unless—

“(a) That portion is first included in the measurement of the gross tonnage; and

“(b) A surveyor appointed under the fourth part of the Merchant Shipping Act of 1854 certifies that the portion so framed in is reasonable in extent, and is so constructed as to be safe and seaworthy, and that it cannot be used for any purpose other than the machinery, or for the admission of light and air to the machinery or boilers of the ship.”

International Tonnage.—This extract completes all that need be said respecting existing tonnage laws for British merchant ships, and attention will next be directed to the use of the Moorsom system for *international* purposes. This was first done in connection with the Danube navigation. In 1860 the English law of 1854 was adopted, factors being used to convert the tonnages of other than English ships into approximate English measure. Subsequently the allowances for propelling machinery-space were modified as above described. In 1873 an International Commission on Tonnage met at Constantinople, specially with reference to the assessment of Suez Canal dues, and the settlement of the tonnage on which dues should be paid. While adopting the Moorsom system, the Commission proposed stricter regulations in regard to deck-erections and a different method of engine-room allowance than are contained in the English law. The Suez Canal Rules respecting enclosed spaces are as follows:—

“By permanently covered and closed-in spaces on the upper deck are to be understood all those which are separated off by decks, or coverings, or fixed partitions, and therefore represent an increase of capacity, which might be used for stowage of merchandise, or for the berthing and accommodation of the passengers or of the officers or crew. Thus any one or more openings either on the deck or coverings, or in the partitions, or a break in the deck, or the absence of a portion of the partition, will not prevent such spaces being comprised in the gross tonnage if they can easily be closed in after admeasurement, and thus better fitted for the transport of goods and passengers.”

The essential difference from the English law will be seen to lie in the addition to gross tonnage of spaces which "can easily be closed in." It was also provided that "spaces under awning decks without other connection with the body of the ship than the props necessary for supporting them, and which are permanently exposed to the weather or the sea, will not be comprised in the gross tonnage, although they may serve to shelter the ship's crew, the deck passengers, and even merchandise known as deck-loads." The regulations for deck-loads under the Act of 1876 are therefore in excess of Suez Canal measurement.

The spaces measured for the gross tonnage in all ships are: Space under the tonnage deck; space or spaces between tonnage deck and uppermost deck; all covered or closed-in spaces, such as poop, forecastle, officers' cabins, galleys, cook-houses, deck-houses, wheel-houses, and other enclosed or covered-in spaces employed for working the ship. The deductions permitted in all ships are: Berthing accommodation for the crew in forecastle and elsewhere—not including spaces for stewards and passengers' servants; berthing accommodation for the officers, except the captain; galleys, cook-houses, etc., used exclusively for the crew; covered and closed-in spaces above the uppermost deck employed for working the ship. In none of these spaces must cargo be carried or passengers berthed, and the total deduction under all these heads must not exceed 5 per cent. of the gross tonnage. In steamers with *fixed* coal-bunkers the German Rule (see p. 63) may be followed, or the owners may choose to have their vessels measured by the Danube Rule. Vessels with *shifting* bunkers would be measured by the Danube Rule. In no case, except in tugs, must the deduction for the propelling power exceed 50 per cent. of the gross tonnage; so that the minimum tonnage upon which a vessel can pay dues in passing through is 45 per cent. of her gross tonnage. The actual average deduction from the gross tonnage of merchant steamers using the canal is estimated at about 30 per cent. Owing to the different methods of making the deductions, a British ship has to pay Suez Canal dues upon a tonnage exceeding by about 10 to 12 per cent. that on which she is assessed in home ports. War-ships, as well as merchantmen, use the canal, and have to pay dues. For this purpose all the ships of the Royal Navy are measured by surveyors of the Board of Trade, and furnished with special tonnage certificates. In them the deductions from the gross tonnage vary from 30 to 50 per cent., according to the class of ship. In 1876 the Danube Commission officially adopted the Suez Canal Rules, so that the same certificates are now available for both navigations.

In 1874 a bill was introduced into the House of Commons to

assimilate the English tonnage law to the Suez Canal Rules, but it did not pass. Some of the recommendations of the Royal Commission of 1881 were in the same direction; these have not been acted on. It is curious to note that the Suez Canal Rules are, in the main, based on proposals made by our own Board-of-Trade officials, many of which have been presented to but not accepted by Parliament.

International tonnage has many obvious advantages, and if ever a universal law is arranged by maritime nations, it will probably be based on the Suez Canal regulations. Even as matters now stand, much advance has been made during the last thirty years by the general adoption of the Moorsom system. The United States, Denmark, Austro-Hungary, France, Germany, Italy, Spain, Sweden, the Netherlands, Norway, Finland, Greece, Russia, Hayti, Belgium, Japan, Chili, and the Argentine Republic have followed the lead of this country, although they have dealt with engine-room deductions, enclosed spaces, etc., in a manner differing from the Act of 1854, and in some cases have laid down different rules for computing under-deck tonnage. Crew-space deductions for nearly all these countries are limited to 5 per cent. of the gross tonnage. According to the latest information in our possession, engine-room deductions are dealt with as follows: Austria, Italy, Finland, France, Hayti, and Japan use the English Rules; Germany, Sweden, Norway, Russia, and Belgium adopt the "German" Rule; the United States, Denmark, Spain, the Netherlands, and Greece use the "Danube" Rule. For convenience, and the avoidance of the necessity for remeasurement, the tonnage of the measured machinery-spaces and permanent coal-bunkers (if any) might be officially recorded by all countries, as they are on the Suez Canal certificates. It is stated on good authority that for steamers above 1000 tons (gross tonnage) the nett registered tonnages by British Rule have been found to average about 10 per cent. less than the corresponding tonnage by the Danube Rule, and about 16 per cent. less than by the German Rule.

Alternative Systems of Tonnage for Merchant Ships.—Although the Moorsom system of tonnage is now almost universally accepted, there are not wanting advocates of change, on the ground that internal capacity is not a fair basis for taxation. These views were strongly expressed in evidence given before the Royal Commission of 1881, in dissentient reports by two eminent commissioners, and have been endorsed by French writers of repute. Undoubtedly the greatly preponderating weight of opinion amongst shipbuilders and shipowners is contrary to change in the basis of measurement; and the inconveniences attaching to such a change are very serious. This feeling has had much to do, no doubt, with the opposition shown

to the amendments in the Act of 1854, above described, although they are undoubtedly desirable on many grounds. To an entire alteration in the basis of tonnage, which has worked well, on the whole, for nearly forty years, much greater opposition may be anticipated. It may be interesting, however, to indicate briefly the nature of some of the alternative proposals which have been brought forward in recent years.

The first, supported by the late Mr. Waymouth, then secretary to Lloyd's Register, and a member of the Commission of 1881, was to return to a *dead-weight* basis of measurement.

Mr. Waymouth maintained that, as the great majority of ships are engaged in carrying cargo and not passengers, the tonnage laws should be especially suitable to them. Freights, as a rule, are now based upon the dead-weight capability of ships; and when light measurement goods are carried, the rates are raised proportionately. In other words, it is asserted that the fundamental principle laid down by Mr. Moorsom no longer holds good; that *internal capacity* in the present conditions of the shipping trade is not the fair measure of the possible earnings of ships under most circumstances, whereas *dead-weight capability* is. This view of the matter is disputed, but the question cannot be discussed here. It may be observed, however, that the special mechanical appliances for packing in small compass many descriptions of light goods, have produced remarkable reductions in the space required for their stowage since the date when Mr. Moorsom wrote; while the change from wood to iron and steel, and the modifications introduced in modern types, have tended to increase the internal capacity available for stowage. Starting from this assumption, Mr. Waymouth proposed to ascertain the *light-line* to which a ship would be immersed when equipped for sea, but without cargo on board. For sailing vessels, no consumable stores would be on board; for steamers, the engines would be complete, and the water in the boilers, but no coals would be on board when the light-line was ascertained. A maximum load-line would be fixed by some central authority for each ship. The dead-weight capability would then be easily and accurately estimated, being the number of tons of sea water displaced by the ship between her light and load-lines. For passenger-ships it was proposed to place the load-lines exactly as if they were cargo-ships, and at the maximum height above the keel compatible with safety; although it is admitted that these vessels would never in their regular service load so deeply. The reason given is "that no shipowner will carry light freight, passengers, or cattle unless he earns at least as much as if he were carrying a dead-weight cargo."

A "register ton" according to this system would be 20 cwt.

avoirdupois, and it may be interesting to inquire how it would be related to the register ton under the existing system. There is, of course, no constant ratio between the two, the relative accommodation assigned to cargo or passengers in different classes of ships, the variations in the relative weights of machinery in various types of steamers, and other circumstances affecting the ratio. In 1860 Mr. Moorsom gave the following rule: "To ascertain approximately the dead-weight cargo which a ship can safely carry on an average length of voyage, deduct the tonnage of the spaces appropriated to passenger accommodation from the nett register tonnage, and multiply the remainder by the factor $1\frac{1}{2}$." At present in iron and steel sailing ships the corresponding ratio usually lies between $1\frac{1}{4}$ and $1\frac{1}{2}$; in cargo steamers, $1\frac{3}{4}$ is a fair average, but 2 to $2\frac{1}{4}$ is said to occur. For passenger steamers the ratio of dead weight to nett tonnage varies greatly with differences in the speed as well as in the proportionate importance of cargo and passengers, and in some of the swiftest seagoing vessels is less than unity.

Hence it will appear that difficulties would arise in changing from the present basis to a dead-weight basis, if it were desired for statistical purposes to leave unchanged the nominal aggregate tonnage of the British mercantile marine. This has been considered a matter of some importance in all revisions of the tonnage laws so far made. Mr. Waymouth did not have regard to this consideration: his system would make the aggregate tonnage considerably greater than at present. It would be possible, no doubt, to keep the aggregate register tonnage of the mercantile marine unchanged, if the labour of determining the total dead-weight tonnage were incurred, and a divisor found expressing the ratio of that total to the present total register tonnage. But it would still remain true, for the reasons given above, that the nominal tonnage of different classes of ships would be very differently affected by the use of this divisor in all cases, because the ratio of the dead-weight capability to the present register tonnage varies so greatly.

Since Mr. Waymouth made his proposal, one of the great objections raised to his scheme has been removed by the settlement of the load-line question for merchant ships (see p. 13). This does not dispose, however, of the objection that for passenger-steamers and for vessels built to carry light cargoes he proposed to have a "tonnage load-line" deeper than the vessels would ever be sailed at, and based upon perfectly hypothetical conditions. Here lay the novel feature of the scheme, and it does not commend itself. In other respects the plan is identical with that favoured by writers of the seventeenth century.

Another method of estimating tonnage by dead-weight has been

proposed at different times, but never adopted. The tonnage on which dues were to be paid was to be governed by the number of tons of cargo carried on each voyage; and to assist in ascertaining the dead-weight on board, an officially guaranteed "curve of displacement" was to be carried by each vessel (see p. 5). It will be seen, therefore, that the tonnage of a ship would be a variable quantity. Moreover, the attempt to assess earnings by the dead-weight carried could not possibly succeed, since it leaves almost untaxed the extremely valuable earnings obtained from the carriage of passengers, and treats too favourably the cases where light cargoes are carried. As regards statistical uses, this form of dead-weight tonnage would be more objectionable than that described above.

The second proposal for a change in the tonnage law was embodied in a separate report by the late Mr. Rothery (Wreck Commissioner), who was also a member of the Royal Commission of 1881. It may be shortly described as a proposal to make "displacement tonnage" the basis of all dues. This also was a revival of a proposal made years ago, and, like dead-weight measurement, it required the fixing of a load-line for each ship, either by the ship-owner or by some central authority. It was further suggested that, for the purpose of bringing the register tonnage obtained on the new basis into approximate agreement with the present register tonnage, the actual displacement (in tons avoirdupois) should be divided by some factor. Here, however, difficulties must arise, corresponding to those mentioned in connection with the attempt to deal similarly with dead-weight measurement and the present register tonnage. The factor to be used would have very different values in different classes of ships, with different structural arrangements, and different reserves of buoyancy. Even in comparisons between the gross tonnages and the displacements of ships considerable variations occur, due to the wide divergencies in reserves of buoyancy and methods of construction. In ocean-going steamers the gross tonnage may vary from *two-thirds* to *one-half* of the displacement (in tons); in sailing ships, between *one-half* and *five-elevenths* of the displacement. When we pass from gross to nett tonnage on the present system, these ratios of tonnage to displacement are very little altered in sailing ships, but very considerably and unequally affected in different classes of steamers, owing to the nature of the deductions for propelling-space. For statistical purposes, therefore, the change to a displacement basis would involve some difficulty.

Mr. Rothery advocated a displacement basis for tonnage, on the grounds that, if the load-line is fixed, the tonnage can be accurately estimated, without difficulties arising as to structural arrangements,

propelling-space, erections on deck, etc.; and that this tonnage is the fairest for assessing dock and harbour dues, because it corresponds to the water-space actually occupied. Recognising the fact that in both the Moorsom system and in dead-weight measurement, an endeavour is made to roughly assess the *earnings* of ships, Mr. Rothery contended that the true basis for canal, river, dock, and harbour dues is to be found, not in the earnings of ships, but in the *service rendered* to them.* This service is supposed to be measurable by the *space occupied* by a ship, represented by her displacement, and by the *time* during which it is occupied. Light dues are treated as of minor importance when compared with dock and harbour dues.

Turning to the objections to this proposal, independently of those connected with fixing the load-line, which have been removed by recent legislation, it must first be noticed that the displacement is not a fair measure of the space required by a ship in dock or harbour. That space is more fairly measured by the parallelepipedon of which the length equals the length of the ship "over all," the breadth is her extreme breadth, and the depth her mean draught, unless she trims excessively by the stern. For it is evident that if these three leading dimensions are the same, the possibility of berthing other ships in a dock or harbour is not altered by variations in the "coefficient of fineness" for displacement (see p. 3). And we have seen that the coefficients of fineness may vary from 78 down to 40 in ships of different classes, but with the same extreme dimensions.

Next, it is said that a displacement basis would furnish strong inducements to the construction of excessively light hulls and engines, in order that on a given displacement the greatest dead-weight carrying power might be secured. There is force in this argument, but it applies with practically equal force to ships built to carry dead-weight cargoes under the present tonnage law. The tendency to undue lightness of construction is always kept in check by careful surveys, such as are made on nearly all merchant ships by officers of the great registration societies.

A third proposal put before the Royal Commission was to base dock-dues, etc., upon either the area of the rectangle having the length over all and breadth extreme of a ship, or upon the volume

* The reader interested in this subject may turn with advantage to the evidence given by Sir Thomas Farrer, late secretary to the Board of Trade, before the House of Commons Com-

mittee on the Tonnage Bill of 1874, where this distinction between the two systems of taxation is admirably stated and illustrated.

obtained by multiplying that area by the draught. This class of proposal will be seen to approximate to that made by Bouguer in 1746.

It proceeds upon the assumption that dock and harbour dues should be paid on service rendered, and not on the earning powers of ships; and this assumption, as has been shown, is not generally admitted. While the circumscribing parallelopipedon is a moderately fair measure of water-space occupied, it is very properly urged that varying circumstances affect the cost of construction of docks greatly, making quay-space very expensive of provision in some cases, or depth of water in others. In other words, a complete revision of dock dues and much legislation would have to be effected if on other grounds such a radical change of system were made. These and international obligations are the most serious objections raised. It has been urged, further, that for statistical purposes the change would be objectionable, and this must be admitted. The objection that the parallelopipedon system would encourage the production of box-shaped vessels does not seem to have much force; for it is not probable that under existing conditions shipowners would sacrifice speed, economy under steam, and good behaviour at sea simply to increase the ratio of dead weight or capacity to nominal tonnage.

In view of the full discussion of the subject in 1881, and the recommendations of the Royal Commission, as well as the continuous extension of international obligations, it is obvious that the Moorsom system is now more thoroughly established than ever, and that no change seems probable, except as regards improvement in details.

Freight Tonnage.—A few words will suffice respecting another kind of tonnage measurement commonly employed in the mercantile marine. *Freight tonnage* is simply a measure of cubical capacity. Merchants and shipowners make considerable use of this measurement, although it has no legal authority; it is also used in the Admiralty service in connection with store ships and yard-craft. A freight-ton, or "unit-of-measurement cargo," simply means in most cases 40 cubic feet of space available for cargo, and is therefore two-fifths of a register ton.

In some cases the internal capacity of a ship available for freight is expressed in tons of 50 cubic feet, this unit having especial reference to import goods loaded in India. The freight-ton is, of course, a purely arbitrary measure, but has a definite meaning, and is of service in the stowage of ships.

Mr. Moorsom estimated that in the ships built thirty years ago for an average length of voyage the nett register tonnage, less the tonnage of the passenger space, when multiplied by the factor $1\frac{2}{3}$,

would give a fair approximation to the freight-tons for cargo stowage. This rule cannot be applied to ships of the present day, which differ greatly from their predecessors in structural arrangements and propelling apparatus. It is now the practice of shipbuilders, however, to furnish drawings showing the capacity of the several holds in cubic feet; and this information, taken in association with the form and structure of a ship, is of great value in dealing with stowage.

War-ship Tonnage.—It has been stated above that until 1872 the official tonnages of British war-ships continued to be estimated by "Builder's Old Measurement"; this was simply for *Navy List* and statistical purposes. The defects of the old measurement were fully recognized, and often taken advantage of in giving small nominal tonnages to ships of large displacements. For example, deductions were made for "rake" of stern-posts long after these were upright. In other cases the "breadth for tonnage," when armour projected beyond the hull, was made 4 feet less than the extreme breadth. Similar action was taken to even a later date in the United States navy; but in most foreign navies *displacement tonnages* (for the fully laden and equipped condition) had been used for many years previously to our change of system in 1872. The designers of British war-ships had also long worked on a displacement basis, although bound to the official measurement in published lists. For a few years both displacement and B.O.M. tonnages appeared in the *Navy List*; now only displacements are given.

Displacement tonnage, as explained on p. 2, expresses the total weight of a ship (in tons) when immersed to her maximum draught or "load-line." For war-ships this measurement is especially suited, since they are designed to carry certain maximum weights, and to float at certain load-lines, which are fixed with reference to the character of the service. It will be obvious, however, that a simple comparison of displacements affords no means of judging the relative powers of two war-ships. A displacement of given amount may be very differently distributed in different ships. For example, one may be an armoured coast-defence vessel of low speed, small free-board, heavily protected and armed, but carrying small weights of coal or equipment. Another may be a sea-going armoured ship with high sides, large coal-supply and equipment, higher speed, with lighter armour and armament. A third may be an unarmoured cruiser of very high speed, intended to keep the sea for long periods with large coal-supply, good equipment, and light armament. In each of these cases and others which might be mentioned the distribution of the constant displacement into the various percentages assigned to hull, machinery, coals, armament, armour, and

equipment will necessarily vary greatly. Consequently it is desirable, when using displacement tonnage as a means of comparison for war-ships, and in order to estimate the skill displayed by designers, to restrict the comparison to ships of similar types, built for similar service.

Since the opening of the Suez Canal all British war-ships have been measured by surveyors of the Board of Trade, and furnished with official certificates of their "gross" and "nett" tonnages according to Suez Canal Rules. Dues in passing through are paid on the "nett" tonnage of a ship. When war-ships are docked in private docks abroad, the charges are usually based on the "gross" tonnage.

Prior to the financial year 1874-5 the programmes for tonnage of new ships building or to be built appeared in the Navy Estimates, as "Tons B.O.M." From 1875 to 1885 another tonnage-unit appeared in the Estimates; it has now been abolished, but it may be useful to explain what this statistical "ton" meant. When a new ship is designed, an estimate is made of the total weight (in tons) of her hull and fittings, as well as the cost of the labour to be expended on her construction. The *average cost of the labour* to be expended in building *one ton weight of hull* was ascertained from these estimates; and in the period 1875-85 that "average expenditure per ton" was called a "ton" in the shipbuilding programmes. It is unnecessary to criticize an arrangement which was open to grave misconception, and has been abandoned. For purposes of information, it may be added that on an average a "ton" in the shipbuilding programmes 1875-84 about equalled 91 per cent. of a "ton" for armoured ships in preceding programmes, and 144 per cent. of a "ton" for unarmoured ships.

Yacht Tonnage.—All British yachts are measured by surveyors of the Board of Trade, and their "register tonnages" are determined. For the purposes of regulating time allowances in racing, or classifying yachts, special tonnage rules are employed. A brief description of some of the most important of these rules will now be given.

Up to the year 1880 the "Thames Rule," or some modification thereof, was generally adopted in this country. It ran as follows:—

(a) The length is measured on the deck from the fore part of the stem to the after part of the stern-post (CD in Fig. 31, p. 48); let this be called L.

(b) The breadth is measured to the outside of the outside plank at the broadest part wherever found; let this be called B.

(c) From the length the breadth extreme is deducted, the remainder being the "length for tonnage." This length for tonnage

is multiplied by the breadth, and their product by half the breadth; the result divided by 94 gives the tonnage. In algebraical language—

$$\text{Tonnage (Thames measurement)} = \frac{(L - B) \times B \times \frac{B}{2}}{94}$$

As an example, take the case of a yacht for which the length (L) is 102 feet; breadth extreme (B) 21 feet.

$$\begin{aligned} \text{Tonnage (Thames Measurement)} &= \frac{(102 - 21) \times 21 \times \frac{21}{2}}{94} \\ &= \frac{81 \times 21 \times 21}{94 \times 2} = 190 \text{ tons.} \end{aligned}$$

The Yacht Racing Association adopted the Thames Rule in 1876, and up to 1882 used it with the following modification: The length was measured from out to out on the load-line, it being provided that "if any part of the stern or stern-post or other part of the vessel below the load water-line project beyond the length taken as mentioned, such projection or projections shall, for the purposes of finding the tonnage, be added to the length taken as stated." It will be noted that these rules were based upon the B.O.M. rule; only the yacht-owner, naturally seeking to secure speed, and consequently favouring good form and ample stability, had not the same inducements to malform his vessel which the owner of the cargo-ship had under the B.O.M. rule.

These rules put a severe penalty on beam as compared with length; and, since they took no account of depth, designers were not slow to avail themselves of the possibility afforded them to use large weights of ballast placed low down for the purpose of securing large sail-carrying power on vessels of great length, small beam, and small nominal tonnage. It is admitted that this deep, narrow type of vessel is practically uncapsizable and very well-behaved at sea (see Chapter III.). It is also claimed for the Thames Rule, and its modification, that it brought the type of yacht built specially to sail under it into fair competition with other types of yachts, such as the American, built to sail under other tonnage rules. Furthermore it appears that the Thames Rule approximately expressed the sail-carrying power of yachts (see Chapter XII.). But notwithstanding all these considerations, and the dislike of many yachtsmen to a change of rule, the Yacht Racing Association have introduced new systems of measurement, designed especially to check the tendency to greater length, narrower beam, and more ballast in yachts of different classes.

The Yacht Racing Association Rule of 1882 measured the length and breadth as before, and expressed the tonnage by the equation—

$$\text{Tonnage} = \frac{(\text{length} + \text{breadth})^2 \times \text{breadth}}{1730}$$

A fraction counts as a ton. The divisor was so chosen as to keep the tonnage of existing yachts very nearly the same as under the previous rule. It will be observed that no actual measurement of depth appears in the amended rule, which is in this respect no improvement upon its predecessors. It continued in use until 1886, and was then cancelled in favour of a rule proposed by Mr. Dixon Kemp, which estimates "rating" or tonnage for racing purposes) in terms of the water-line length and sail-area only. This amended rule is—

$$\text{Tonnage (rating)} = \frac{\text{length on water-line} \times \text{sail-area}}{6000}$$

Length measured in feet; sail-area in square feet. The fundamental ideas on which it rests are that speed is largely dependent upon length, and also upon "driving-power," or sail-area. It is claimed for this rule that it gives greater latitude to designers in the choice of proportions of yachts which may be fairly sailed together if of equal rating, and that it encourages greater ratios of breadth to length than under previous rules.

At the end of 1892, after six years' experience of the working of this rule, and a thorough inquiry conducted by a special committee, the council of the Association came to the conclusion that "no sufficient reason has been given for at present altering the existing "rule," and recommended its retention. They decided, further, not to tax "overhangs" at the bow and stern above water, nor to interfere in any way with the forms of yachts. They recommended that the load water-line which is to be measured for rating should be marked at the bow and stern, and proposed certain amended methods for measuring the sails. In all essentials they maintained the rule of 1886, which may be expected, therefore, to remain in use for some time longer, as it has given satisfaction on the whole.

Besides these rules for yacht-tonnage, there are many others which have been proposed or employed to a limited extent. None of these are free from objection, but a few of the principal alternative rules may be described. In 1874, the Corinthian and New Thames Yacht Clubs adopted the following rule for a short time, but eventually abandoned it, in consequence of the objections raised by yachtsmen:—

$$\text{Tonnage} = \frac{\text{length} \times \text{breadth} \times \text{depth}}{200}$$

In this rule the length and breadth for tonnage were measured as in Thames measurement, the depth being the *total depth* up to the top of the covering board. One obvious objection to the use of the total depth is that owners desiring to decrease the nominal tonnage would be tempted to decrease the height out of water to an objectionable, although not to a dangerous, extent.

Displacement tonnage has been advocated for British yachts, and was formerly in use for American yachts. It is urged in favour of this mode of measurement that it would bring yachts into the same category as other classes of ships, for which economical propulsion is measured by the power required to drive a given weight at a given speed. Also that the designer would then have absolute freedom in choosing forms and proportions. On the other hand, it is argued that displacement tonnage favours the construction of mere "racing machines," vessels broad in relation to length, with shallow hulls, deep keels, and small range of stability, although exceedingly stiff (see Chapter III.). These objections are emphasized by reference to the yachts actually built in America to sail under displacement rules, which had a very small displacement in proportion to their extreme dimensions, great "stiffness," large sail-areas, and high speed in smooth water, but which proved inferior to the English type of yachts when sailing in strong winds and heavy seas. This displacement rule has now been abandoned in America, and there is no probability of its adoption in this country. Minor objections to its use have been raised on the grounds that variations in the amount of ballast carried at different times would necessitate variations in time-allowance; also that many owners would object to having their yachts measured accurately, fearing that their forms might be reproduced or improved upon. Little weight attaches to these objections, however, as compared with those stated above.

Another proposal which has found much favour, and has even been temporarily adopted, is to base time-allowances upon the *sail-areas* of yachts. One of the strongest advocates of this method used the following arguments: "If, with smaller sails, we outsail our rival, who can say that an improvement in the form of the vessel is not the cause? we have given the owner a yacht of equal size and greater velocity." Further, it is asserted as an observed fact that, when two well-designed yachts of dissimilar forms are sufficiently near to equality of size to permit of competitive sailing, their speeds will be about equal under most conditions, if the sail-spreads are of equal area. A very common practice has been to proportion the total sail-spread of yachts to the area of the load water-plane, or to the product of the extreme length and breadth of that plane. The New York Yacht Club, therefore, formerly based time-allowances

upon the product of these two extreme dimensions, instead of upon sail-area, which would have involved greater difficulties in measurement. It will be observed, however, that the reasoning upon which the proposal is based takes account of size or displacement as well as sail-areas; and that some definite regulation would be needed as to the "classes" in which yachts should be ranged for competitive sailing. Hence would arise considerable difficulty in practically applying the proposal.

The Seawanhaka Yacht Club of New York and the New York Yacht Club have used rules based upon length on water-line (L), and sail-area (S), but differing from the Yacht Association Rule.

$$\text{Seawanhaka "corrected length"} = \frac{L + \sqrt{S}}{2}$$

$$\text{New York " " " } = \frac{(L \times 2) + \sqrt{S}}{3}$$

These are clearly empirical rules, although they may serve the purpose intended for a time.

The French *Union des Yachts* during 1892 held a congress for the consideration of the rules for tonnage-rating. After considering a large number of proposals, the congress approved the following rule:—

$$\text{Tonnage} = \frac{\left(L - \frac{P}{4}\right) \times P \times \sqrt{S}}{130}$$

In this formula—

L = the length at the water-line (in metres), with any projections under water, except the rudder, added. This water-line has to be marked on the yacht. "Overhangs" (knees of the head and counters) are not to be reckoned except the sums of their lengths (taken at the deck) exceed half the lengths at the water-line. All such excesses to be added to the length.

P = the perimeter (in metres), measured as follows: A chain to be passed under the yacht at the place where the girth (measured to top of deck) is greatest. To this add the greatest beam to outside of planking (excluding special projections or thick strakes).

S = area of sails (in square metres) measured in a manner of which the details are prescribed.

There is an obvious intention here to take account of depth as well as beam, length, and sail-spread. It will be interesting to see how this new rule works.

Some eminent authorities in yacht-construction have favoured the determination of time-allowances on the basis of the "sail-carrying powers." It is clearly of the greatest importance to the speed of yachts that they should be capable of "standing-up" under their canvas; but before any rule of this kind could be used, much more care would have to be bestowed upon the exact determination of the stability of yachts.

Other methods for estimating yacht tonnage for time-allowances proceed on the assumption that the length, or some function of the length, should be the basis of measurement. Rules of this kind have been used in America, but in this country they have been applied only to boats or small yachts. External bulk, measured to the top of the upper deck planking, has also been used in America and advocated here. Another proposal has been to use the register (or fiscal) tonnage of yachts—a measure of their internal capacity. This last suggestion is simple; but variations in the structures of yachts, affecting the thicknesses of their sides, would make the "register tonnage" a very unfair comparison of their external bulk, and there would be a temptation to decrease the freeboard, in order to lessen the tonnage, whether measured by internal capacity or by accurate determination of the outside shape. Besides these various rules there are many others in force, for small boats, canoes, and yachts. Space fails, however, for the further discussion of this interesting subject; and it must suffice to add that each rule inevitably tends to produce its special type of vessel, adapted to derive the greatest advantage by the combination of small nominal tonnage with large driving-power.*

* The reader desirous of pursuing the subject further will find a full discussion of existing tonnage-rules used in estimating time-allowances in Mr. Dixon Kemp's "Manual of Yacht and Boat Sailing," and "Yacht Architecture."

CHAPTER III.

THE STATICAL STABILITY OF SHIPS.

A SHIP floating freely and at rest in still water must fulfil two conditions: first, she must displace a weight of water equal to her own weight; second, her centre of gravity must lie in the same vertical line with the centre of gravity of the volume of displacement, or "centre of buoyancy." In the opening chapter the truth of the first condition was established, and it was shown that the circumstances of the surrounding water were unchanged, whether the cavity of the displacement was filled by the ship or by the volume of water displaced by the ship. When the ship occupies the cavity, the whole of her weight may be supposed to be concentrated at her centre of gravity, and to act vertically downwards. When the cavity is filled with water, its weight may be supposed to be concentrated at the centre of gravity of the volume occupied (*i.e.* at the centre of buoyancy), and to act vertically downwards; the downward pressure must necessarily be balanced by the equal upward pressures, or "buoyancy," of the surrounding water; therefore these upward pressures must have a resultant also passing through the centre of buoyancy. In Fig. 32, a ship is represented (in profile and trans-

FIG. 32.

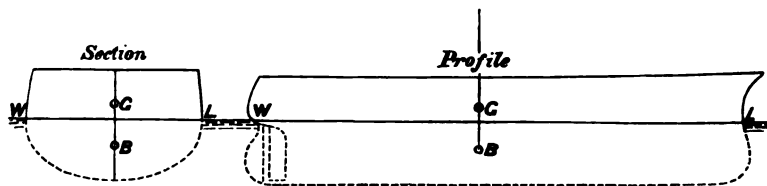

verse section) floating freely and at rest in still water. Her total weight may be supposed to act vertically downwards through the centre of gravity G , the buoyancy acting vertically upwards through the centre of buoyancy B . If (as in the diagram) the line joining the centres G and B is vertical, it obviously represents the common line of action of the weight and buoyancy, which are equal and

opposite vertical forces; in that case the ship is subject to no disturbing forces, and remains at rest, the horizontal fluid pressures which act upon her being balanced amongst themselves. But if (as represented in Fig. 33) the centres G and B are not in the

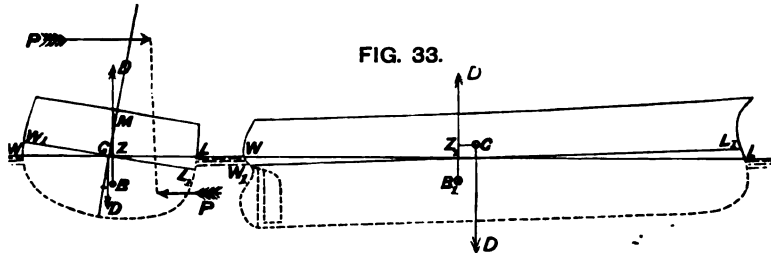

same vertical line, the equal and opposite forces of the weight and buoyancy do not balance each other, but form a "mechanical couple," tending to disturb the ship, either by heeling her or by producing change of trim or causing both these changes. If D = total weight of the ship (in tons), and GZ = perpendicular distance between the parallel lines of action of the weight and buoyancy (in feet)—

$$\text{Moment of couple} = D \times GZ \text{ (foot-tons).}$$

If the vessel is left free to move from this position, not being subjected to the action of external forces other than the fluid pressures, she will either heel or change trim, or both heel and change trim until the consequent alteration in the form of the displacement brings the centre of buoyancy into the same vertical with the centre of gravity G . It is important to note that, for any specified distribution of weights in a ship, supposing no change of place in those weights to accompany her transverse or longitudinal inclinations, the centre of gravity is a *fixed point in the ship*, the position of which may be correctly ascertained by calculation. On the contrary, the centre of buoyancy varies in position as the ship is inclined, because the form of the displacement changes. Hence, in treating of the stability of ships, it is usual to assume that the position of the centre of gravity is known, and to determine the place of the centre of buoyancy for the volume of displacement corresponding to any assigned position of the ship. The value of the "arm" (GZ) of the mechanical couple formed by the weight and buoyancy can then be determined. If it is zero, the vessel floats freely and at rest, in other words, occupies a "position of equilibrium"; if the arm (GZ) has a certain value, the moment of the couple ($D \times GZ$) measures the effort of the ship to change her position in order to reach a position of equilibrium. In this latter case the vessel can only be retained in the supposed position by

means of the action of external forces; and if her volume of displacement is to remain the same as when she floats freely, these external forces must also form a mechanical "couple," the equal and opposite forces acting in parallel lines. For example, suppose a ship to be sailing at a steady angle of heel, and the resultant pressure of the wind on the sails to be represented by the pressure P in Fig. 33 (section) acting along a horizontal line. When the vessel has attained a uniform rate of drift to leeward, the resistance of the water will contribute a pressure, P , equal and opposite to the wind-pressure; and if d be the vertical distance between the lines of action of these pressures, we have—

Moment of couple formed by horizontal forces = $P \times d$ (foot-tons);

which moment will be balanced by that of the couple formed by the weight and buoyancy. Hence—

$$D \times GZ = P \times d,$$

is an equation enabling one to ascertain the angle of steady heel for a particular ship, with a given spread of sail, and a certain force of wind.

Supposing a ship, when floating upright and at rest, to be in a position of equilibrium, which is the common case: let her be inclined through a very small angle from the initial position by the action of a mechanical couple. If, when the inclining forces are removed, she returns towards the initial position, she is said to have been in *stable equilibrium* when upright; if, on the contrary, she moves further away from the initial position, she is said to have been in *unstable equilibrium* when upright; if, as may happen, she simply rests in the slightly inclined position, neither tending to return to the upright nor to move from it, she is said to be *neutral* or *indifferent equilibrium*. A well-designed ship floats in stable equilibrium when upright; but many ships, when floating light, without cargo or ballast, are in neutral or in unstable equilibrium when upright, and consequently "loll over" to one side or the other when acted upon by very small disturbing forces. Damage to the skin of a ship which was in stable equilibrium when intact, and the entry of water into the hold, may also produce unstable or neutral equilibrium in the upright position. It will be shown hereafter that there is a marked distinction between such instability and the conditions which lead to the capsizing of ships.

The *statical stability* of a ship may be defined as the effort which she makes when held steadily in an inclined position by a mechanical couple to return towards her natural position of equilibrium—the upright—in which she rests when floating freely. This effort, as explained above, is measured by the moment of the couple formed

by the weight and buoyancy. Hence we may write, for any angle of inclination—

$$\text{Moment of statical stability} = D \times GZ.$$

But in doing so, it must be noted that in all ships, angles of inclination may be attained for which the line of action of the buoyancy, instead of falling to the right of G (as in section, Fig. 34), and so tending to restore the ship to the upright, will fall to the left and tend to *upset* her or make her move away from the upright position.

Starting from the upright, a ship may be inclined transversely, or longitudinally, or in any "skew" direction lying between the two. It is only necessary, however, to consider transverse and longitudinal inclinations in connection with statical stability; the innumerable possible skew inclinations being easily dealt with when the conditions of stability for the two principal inclinations have been ascertained. The *minimum* stability of a ship corresponds to transverse inclinations; the *maximum* stability, to longitudinal inclinations. It is, therefore, of the greatest importance to thoroughly investigate the changes in the statical stability of ships as they are heeled to greater and greater transverse inclinations, especially for ships which have masts and sails. Longitudinal stability is less important, but claims some notice, especially as regards its influence on changes of trim and pitching motions.

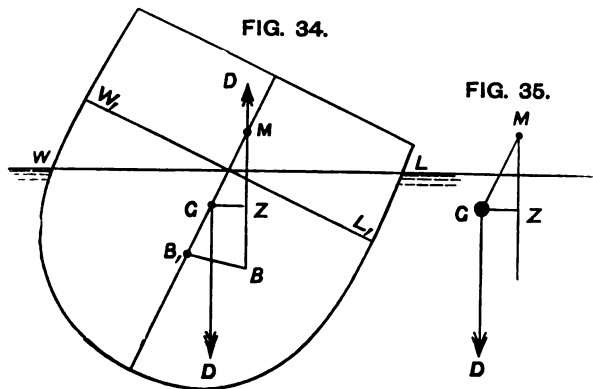

Taking first transverse inclinations, let them be supposed to be small; it is then easy to estimate the statical stability when the position of the *metacentre* is known. For our present purpose the metacentre may be defined, with sufficient exactitude, as the intersection (M in the cross-section, Fig. 34) of the line of action (BM) of the buoyancy when the ship is inclined through a very small angle, with the line of action (B_1GM) of the buoyancy when the ship is upright and at

rest. In vessels of ordinary forms, no great error is introduced by supposing that, for angles of inclination between the upright and 10 or 15 degrees, all the lines of action of the buoyancy (such as BM) pass through the same point (M)—the metacentre. For any angle of inclination α within these limits the perpendicular distance (GZ) of the line of action of the buoyancy from the centre of gravity is determined by—

$$GZ = GM \sin \alpha.$$

Hence by what is usually termed the “metacentric method,” it follows that—

$$\text{Moment of statical stability} = D \times GM \sin \alpha.$$

As an example, take a ship weighing 6000 tons, for which the distance $GM = 3$ feet, and suppose her to be steadily heeled under canvas at an angle of 9 degrees. Then—

$$\begin{aligned} \text{Moment of statical stability} &= 6000 \text{ tons} \times 3 \text{ feet} \times \sin 9^\circ \\ &= 18,000 \times .1564 = 2815 \text{ foot-tons.} \end{aligned}$$

For most ships the angles of steady heel under canvas lie within the limits for which the metacentric method holds; and consequently this method may be used in estimating the “stiffness” of a ship, *i.e.* her power to resist inclination from the upright by the steady pressure of the wind on her sails. It must be noticed that this term “stiffness” is used by the naval architect in a sense distinct from “steadiness.” A *stiff* ship is one which opposes great resistance to inclination from the upright, when under sail or acted upon by external forces; a *crank* ship is one very easily inclined; the sea being supposed to be *smooth and still*. A *steady* ship, on the contrary, is one which, when exposed to the action of waves in a seaway, keeps nearly upright, her decks not departing far from the horizontal. Hereafter it will be shown that frequently the *stiffest* ships are the *least steady*, while crank ships are the *steadiest* in a seaway. At present we are dealing only with still water, and must limit our remarks to stiffness.

From the foregoing remarks it will be evident that, so far as statical stability is concerned, and within the limits to which the metacentric method applies, a ship may be compared to a pendulum, having its point of suspension at the metacentre (M, Fig. 34), and its weight concentrated in a “bob” at the centre of gravity G. Fig. 35 shows such a pendulum, held steadily at an angle α . The weight (W) acting downwards produces a tendency to return to the upright, measured by the moment $D \times GM \sin \alpha$, which is identical with the expression for the righting moment of the ship at the same angle. But this comparison holds only while the ship and the pendulum

are at rest; as soon as motion begins, the comparison ceases to be correct, and the failure to distinguish between the two cases has led some writers into serious error. If the centre of gravity of the ship lies *below* the metacentre, she tends to return towards the upright when inclined a little from it; that is, her equilibrium is *stable*. If the centre of gravity of the ship lies *above* the metacentre, she tends to move away from the upright when slightly inclined; that is, her equilibrium is *unstable*. If the centre of gravity coincides with the metacentre, and the ship is inclined through a small angle, she will have no tendency to move on either side of the inclined position, and her equilibrium is *indifferent*. The metacentre, therefore, measures the height to which the centre of gravity may be raised, without rendering the vessel unstable when upright; and it was this property which led Bouguer, the great French writer to whom we owe the first investigations on this subject, to give the name metacentre to the point.

Changes in the height (GM) of the metacentre above the centre of gravity produce corresponding changes in the stiffness of a ship; in fact, the stiffness may be considered to vary with this height—usually termed the “metacentric height.” If it is doubled, the stiffness is doubled; if halved, the stiffness is reduced by one-half and so on. Care has, therefore, to be taken by the naval architect, in designing ships, to secure a metacentric height which shall give sufficient stiffness without sacrificing steadiness in a seaway. In adjusting these conflicting claims, experience is the best guide.

The vertical position of the centre of gravity of a ship depends upon the distribution of the weights of structure, equipment, and load. Over this distribution the designer has usually but little control. In war-ships, for example, the distribution of weights is governed largely by the freeboard, armament, protection, speed and coal-supply considered suitable in various types. In merchant ships, and especially in cargo-carriers, the case is even more difficult, as the loads vary in amount and character on different voyages; and the designer can have little or no influence upon the stowage of cargo. The weight of cargo in the majority of merchant ships bears a considerable ratio to the weight of hull, propelling apparatus, and equipment. Passenger-steamers, in which the weight of cargo is relatively less, present a simpler problem than cargo-carriers; but in them also the designer has to work within specified conditions, and has little power to vary the vertical position of the centre of gravity.

The vertical position of the metacentre depends upon the form of a ship, especially near the water-line at which she floats, and the extent to which she is immersed. Hence it is possible for the naval

architect to exercise considerable control over its position by means of changes in form. For every water-line at which a ship can float, between her fully laden condition and the extreme light condition, the corresponding vertical position of the metacentre can be determined by exact calculations.

Other requirements have to be fulfilled, of course, concurrently with the provision of the amount of stiffness considered desirable in a new ship, under certain assigned conditions of lading. Questions of propulsion necessarily exercise great influence upon the selection of forms and dimensions. Limitations of draught have to be accepted; and frequently limitations of breadth, in view of the dimensions of dock-entrances. In some instances, other considerations impose such forms and ratios of draught to breadth, as give to vessels a higher position of the metacentre and greater stiffness than would be preferred for good behaviour. Speaking broadly, however, it is true that the naval architect can and does exercise control over the position of the metacentre by changes in forms and proportions.

It has been explained above that when the position of the metacentre is known, it affords a ready means of determining the line of action of the buoyancy for a moderate inclination of a ship of ordinary form, and of avoiding the necessity for determining the place of the corresponding centre of buoyancy. But in practice the position of the metacentre is fixed with reference to the centre of buoyancy, corresponding to the upright position of the ship. The distance (B_1M , Fig. 34) is given by the formula *—

$$B_1M = \frac{\text{moment of inertia of water-line area}}{\text{volume of displacement}}$$

For transverse inclinations, such as we are now considering, the moment of inertia would be calculated about the middle line of the water-line section; and this may be expressed in terms of the length (L) and breadth extreme (B) of that section. It may in fact be written—

$$\text{Moment of inertia} = K \times L \times B^3,$$

where K is a quantity ascertained by calculation for the particular ship. Since the *cube* of the breadth appears in the expression for the moment of inertia, and only the first power of the length, any increase in the breadth must be most influential in adding to the

* The "moment of inertia" of an area about any axis may be defined as the sum of products of each element of that area, by the square of its distance

from the axis. The proof of the formula given above involves mathematical treatment which would be out of place here.

value of the height (B_1M) of the metacentre above the centre of buoyancy.

The drawings of a ship furnish the naval architect with *data* for exact calculations of the volume of displacement, the position of the centre of buoyancy, and the moment of inertia of the water-line area, corresponding to any assigned draught of water. Details of the method of calculation would be out of place here; but it may be of interest to state certain approximate rules derived from such calculations, by means of which rough estimates may be made of the vertical positions of the centre of buoyancy and transverse metacentre in ships of ordinary form.

I. For the approximate depth of the centre of buoyancy below the water-line from *two-fifths* to *nine-twentieths* of the mean draught may be taken. The larger coefficient should be used for ships of full form. If the draught is increased by an unusually deep keel or false keel, the centre of buoyancy will lie higher than in ships of ordinary form. In yachts, for example, it is sometimes distant from the water-line only from 27 to 30 per cent. of the mean draught.

II. For the coefficient K in the formula for the moment of inertia of the water-line area, or plane of flotation, the following approximate values may be taken:—

	K
Ships with extremely fine forms of load } water-lines }	.04 to .045.
Ships with moderately fine forms of ditto } Ships of full forms of ditto }	.05 to .055.
A rectangle }	.06 to .065.
	.083.

In applying these coefficients it must be noted that the length and beam, in the formula for the height of the metacentre above the centre of buoyancy, are to be measured at the load-line; so that these dimensions may differ from the extreme length and breadth.

As an example, take her Majesty's ship *Iron Duke*, for which length (L) is 280 feet, breadth extreme (B) 54 feet, mean draught 22 feet, displacement 6000 tons. Here K should about equal $\frac{11}{200}$. Hence—

$$\begin{aligned} \left. \begin{array}{l} \text{Moment of inertia of water-} \\ \text{line area} \end{array} \right\} &= \frac{11}{200} \times 280 \times (54)^2. \\ \text{Volume of displacement} &= 6000 \times 35. \\ \left. \begin{array}{l} \text{Height of metacentre above} \\ \text{centre of buoyancy } (B_1M) \end{array} \right\} &= \frac{11 \times 280 \times (54)^2}{200 \times 6000 \times 35} = 11.5 \text{ feet.} \\ \left. \begin{array}{l} \text{Also (by Rule I.) approxi-} \\ \text{mate depth of centre of} \\ \text{buoyancy below water} \\ \text{surface} \end{array} \right\} &= \frac{2}{5} \times 22 \text{ feet} = 8.8 \text{ feet.} \end{aligned}$$

Hence the metacentre should be situated about 2·7 feet above the water surface. Exact calculation showed it to be about 2·4 feet above the water surface.

A still more rapid method of approximating to the height of the metacentre above the centre of buoyancy is based upon a combination of the preceding formula, with the rules for "coefficients of fineness" given on p. 3. Calling these coefficients C , and using the same notation as before, we have—

$$B_1M = \frac{K \times L \times B^3}{C \times L \times B \times D}$$

neglecting any small difference there may be between the length between perpendiculars and breadth-extreme of the ship and her greatest dimensions at the load-line. Reducing this expression, it appears that—

$$B_1M = \frac{K}{C} \cdot \frac{B^2}{D} = a \cdot \frac{B^2}{D}$$

which is an expression of the simplest character, and shows how influential upon the height B_1M is the ratio of breadth to mean draught.

It will be noted that the coefficient a increases with increase in the value of K , and decreases with increase in C , the coefficient of fineness for displacement. Consequently the values of a may be practically identical in ships of very different degrees of fineness of form. In the extremely fine cruiser *Blake*, for example, the value of a is ·078, and in the *Royal Sovereign* armoured battle-ship is ·08. Taking a large number of examples, the values found for a range from ·08 to ·1. The latter value applies fairly to the older classes of unarmoured ships in the Royal Navy, and to some merchant ships. For the majority of armoured ships, and for many classes of merchant ships, a has the value ·09. In vessels, like yachts, with very fine under-water forms or deep keels, a rises to ·15. In some vessels of full under-water form, and in others with very fine ends, a has the value ·08. Hence it will be evident that, while the foregoing approximate rules are useful in making rough estimates, the naval architect must adhere to exact calculations for fixing the position of the metacentre in any new design.

By means of a series of such calculations, it is possible to construct a diagram—termed the "metacentric diagram"—showing the vertical positions of the metacentre and the centre of buoyancy for any mean draught of water between the deep load-line at which the vessel floats when fully laden, and the light-line at which she floats when empty. Such diagrams are very useful, especially for merchant

ships subjected to great variations of draught. The construction is very simple. Any horizontal line W_1L_1 (Fig. 36) is taken to represent the maximum load-line of the ship. Through any point W_1 on it a vertical line B_1M_1 is drawn: the depth of the centre of buoyancy corresponding to the load-line is then set down below W_1L_1 on a certain scale, and this fixes the point B_1 . The length B_1M_1 represents, on the same scale, the corresponding height of the metacentre M_1 , above the centre of buoyancy B_1 . Through W_1 the straight line $W_1W_2W_3$ is also drawn, making an angle of 45 degrees with W_1L_1 . Then, for some other water-line parallel to the load-line W_1L_1 (say W_2L_2 , Fig. 36), a corresponding construction is performed. The

FIG. 36.

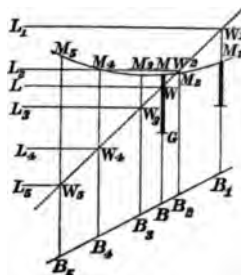

known distance between the two water-lines is set down from W_1L_1 and W_2L_2 is drawn parallel to W_1L_1 ; through the point W_2 , where W_2L_2 cuts the line $W_1W_2W_3$, a new vertical B_2M_2 is drawn. On this vertical are set off, to scale, the calculated depth of the centre of buoyancy (B_2) below the line W_2L_2 , and the height (B_2M_2) of the corresponding metacentre above the centre of buoyancy. A similar process is applied to several other parallel water-lines at still lighter draughts: and so finally a series of points, $B_1B_2B_3\dots$, are determined, through which a curve is drawn, showing the *locus of the centre of buoyancy* for variations in mean draught from the extreme load condition to the extreme light condition. In a similar manner a curve $M_1M_2M_3\dots$ is drawn, giving the corresponding *locus of the metacentres*. Having obtained these curves, it is possible by means of simple measurement to determine the vertical positions of the centre of buoyancy and metacentre corresponding to any water-line parallel to the load-line W_1L_1 and intermediate between it and the light-line. For example, let WL (Fig. 36) represent such a line at a given distance below W_1L_1 . Where WL cuts $W_1W_2W_3$ draw the vertical BWM ; the intersection of this vertical with the metacentric curve gives the position M of the metacentre corresponding to WL ; and its intersection with the curve of centres of buoyancy fixes the position B of the centre of buoyancy. The metacentric locus is the more important, and the other curve is chiefly valuable as the means of constructing that locus. It should be remarked that the metacentric locus only applies accurately to water-lines drawn parallel to W_1L_1 . If, as commonly happens, a ship changes trim considerably as she lightens, then the vertical positions of both centre of buoyancy and metacentre corresponding to the lighter line may not be accurately represented by the points fixed on the metacentric diagram by means

of the *mean draught*, obtained by taking half the sum of the draughts forward and aft.

From the preceding explanations, it will be obvious that in different classes of ships the forms of metacentric curves (such as $M_1M_2M_3$, Fig. 36) may vary considerably.

FIG. 37.

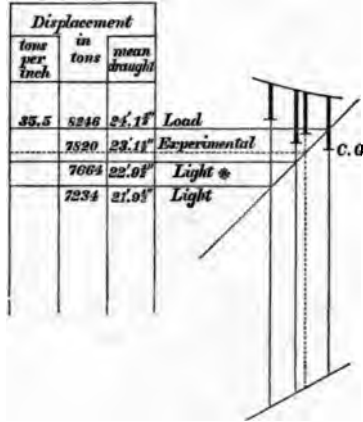

Note.—This diagram represents the variations in metacentric height of H.M.S. *Monarch*. In the Light* condition 430 tons of water-ballast are supposed to be placed in the double bottom.

The only safe course in practice is, therefore, to construct the metacentric diagram for each class. But it may be interesting to give a few typical illustrations of such curves.* Fig. 37 shows a very common case for war-ships of ordinary form; the metacentric curve gradually rises from the load towards the light draught. On the same diagram is indicated a convenient arrangement for the most important *data*—displacement, and tons per inch—at each draught.

Another form occurring less frequently in war-ships makes the metacentric curve almost horizontal between the extreme draughts. In vessels with “peg-top” forms of cross-sections—such as the *Symondite* type of the Royal Navy—the metacentre occupies its highest position in the ship when she is at the load-draught, and falls gradually as the draught lightens (see Fig. 38). Another variety of metacentric locus appears in Fig. 36, where the metacentre first falls as the draught lightens, then passes through a position of minimum height, and gradually rises again. This frequently occurs in merchant ships of deep draught (in proportion to their beam) when fully laden, and with approximately vertical sides in the region between the load and light lines. The highest position of the metacentre in these ships usually corresponds to the light-line; and the lowest to a draught intermediate between the load and light lines: very frequently the heights at the load and light lines are nearly equal, and (as indicated on Fig. 36) the metacentric locus for all variations in draught occurring on service lies wholly below the load-line. In war-ships, on the contrary, that locus usually lies wholly above the

* For further details on this subject see a paper by the author on “The Geometry of Metacentric Diagrams”:

Transactions of the Institution of Naval Architects for 1878.

load-line, the ratio of breadth to load-draught being greater than the corresponding ratio for merchant ships. The range of draught from the load to the light condition is much less for war-ships than for merchant ships.

Metacentric diagrams are chiefly useful as a means of rapidly determining the stiffness of a ship when floating at a certain water-line, and with the centre of gravity in a certain position, which is fixed by an independent investigation. For a certain mean draught and trim, the metacentre remains at a constant height in the ship; and variations in the stowage of a given amount of dead weight can only affect the stiffness by the changes they produce in the vertical position of the centre of gravity. When that position has been ascertained for any given condition of stowage, it is usually shown on the metacentric diagram. For instance, in Fig. 36, when the ship floats at WL with M as the meta-

FIG. 38.

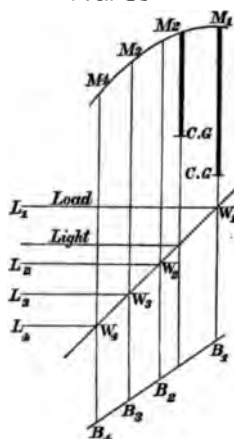

centre, suppose the point G to represent the ascertained position of the centre of gravity. Then GM represents (to scale) the "metacentric height," which measures the stiffness of the ship. For war-ships it is customary to perform this construction for both the load and light conditions, as well as for the condition of the ships when inclined (see p. 103), for the purpose of ascertaining the vertical position of the centre of gravity. For merchant ships the light condition only can be dealt with accurately in the same fashion; since the stiffness in the load condition varies with changes in stowage. In many cases, however, the volumes and common centre of gravity of the total volume of the spaces assigned to cargo are estimated; the maximum load-line is fixed; the corresponding dead weight is ascertained, and thence the number of cubic feet of space available for stowing each ton of dead weight is ascertained. A homogeneous cargo of this density is then supposed to be placed on board, with its centre of gravity at the centre of gravity of the cargo-space. The weight of the ship when floating light, as well as the position of her centre of gravity in that condition, can be readily ascertained by an inclining experiment. Hence, combining the assumed cargo with these experimental data, a final result is obtained for the vertical position of the common centre of gravity of the fully-laden ship; and her metacentric height is determined for the assumed conditions of stowage, which are about as little favourable to stiffness as any conditions likely to occur in actual service, and lie outside the range

of probability in some classes of ships. An interesting extension of this method is shown on Fig. 39.* The metacentric locus is drawn from light to load lines in the usual manner. In the light condition M_1 is the metacentre, and G_1 the centre of gravity of the

FIG. 39.

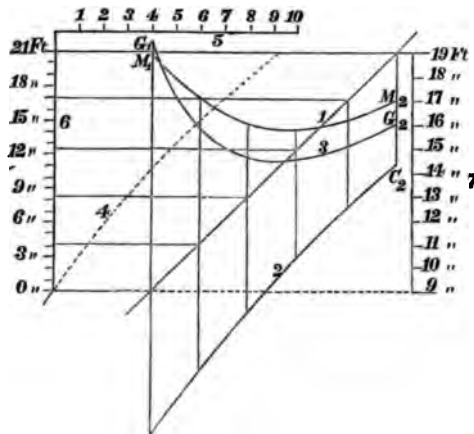

References.—1, Curve of metacentres; 2, curve of centre of gravity of homogeneous cargo; 3, curve of centre of gravity of hull and homogeneous cargo; 4, curve of capacity for space occupied by cargo; 5, scale of capacity (in units of 1000 cubic feet); 6, scale for height of cargo above ceiling; 7, scale of mean draught of water.

ship lies above it, so that the vessel is in unstable equilibrium. It is found that a homogeneous cargo occupying about 58·5 cubic feet per ton of dead weight would just fill the cargo-spaces and bring the ship to her intended maximum load-line. If fully laden in this manner, the homogeneous cargo has its centre of gravity at C_2 , the common centre of gravity of ship and cargo is at G_2 , and the metacentre is at M_2 , about 15 inches above the centre of gravity G_2 . As the ship has taken in cargo, she has therefore acquired stiffness. So far the diagram represents the common practice described above; but it furnishes further information of a valuable character. First, there is a "curve of capacity" giving the volume of the cargo-space corresponding to various heights of cargo in the hold; second, there is a curve giving the locus of the centre of gravity of the cargo-space as the height of the cargo is increased. The curve of capacity resembles in its construction the curve of displacement described on p. 5; and the curve of centres of gravity of cargo-spaces resembles the locus of the centres of buoyancy on metacentric diagrams. Having this data graphically recorded, another step may be taken. Suppose the ship to be taking in cargo of the assumed average specific gravity, and, while her lading is incomplete, to be floating at a given water-line intermediate between the load and light lines. Her displacement at this given line is known; thence the dead weight on board her is easily estimated, also the volume it occupies; the height of its surface and that of its centre of gravity can then

* The author is indebted for this diagram to his friend Mr. John Inglis.

be read off on the appropriate curves of capacity and centres of gravity of homogeneous cargo. Finally, the common centre of gravity of hull and homogeneous cargo can be found for the given water-line. A curve passed through the points G_1 , G_2 , etc., gives the locus of this common centre of gravity of hull and cargo throughout the period of loading; and the relation of this curve to the metacentric curve shows how the stiffness varies, under the assumed conditions, as the loading goes on.

Such a graphic record as that in Fig. 39 can scarcely fail to be of value; although it does not strictly correspond to the conditions of ordinary service, it enables any other conditions to be readily estimated for. The greatest interest, of course, attaches to the two extreme draughts; and of these the fully-laden condition is the more important, as previously indicated.

Fig. 40 contains another example of this method applied to a cargo-steamer; but in this case the curves of capacity and heights of centres of gravity of cargo are omitted. The reference letters agree with those on Fig. 39. Under the assumed conditions of stowage the vessel is in neutral equilibrium when light, and unstable when fully laden, whereas for a considerable range of draught between these extremes she possesses a positive metacentric height, reaching a maximum value of 1 foot about midway between load and light draught. This vessel represents a class which is successfully employed in certain trades, with the frequent use of water-ballast when homogeneous cargoes are carried.

If the coal in a cargo-steamer is stowed low in the hold, it may happen that, as it is burned, and the ship lightens, she will become unstable unless water-ballast is admitted. This actually occurs in some types of ships, and will be readily understood by reference to Fig. 39.

In the case supposed, the metacentre *falls* as the coal is burnt out; while the removal of the coal from the lower hold causes a sensible *rise* in the centre of gravity, and may cause it to rise

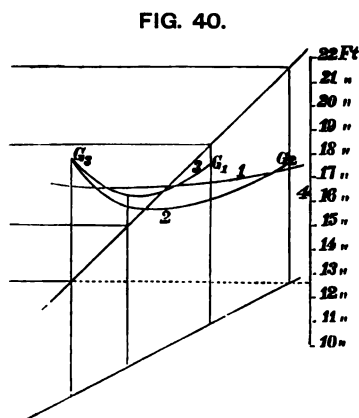

References.— G_3 , centre of gravity of ship without cargo; G_2 , centre of gravity of ship and cargo, supposing the latter to be homogeneous, to fill the holds, and to weigh 2250 tons; G_1 , centre of gravity of ship and cargo, the dead weight being 1430 tons and other conditions as before; 1, curve of metacentres; 2, curve of centre of gravity of ship and cargo as the 2250 tons are discharged; 3, curve of centre of gravity of ship and cargo as the 1430 tons are discharged; 4, scale for mean draughts of water.

above the corresponding metacentre. The necessary instructions for the admission of water-ballast and the maintenance of stability are easily prepared, and may be given in a simple form for the guidance of commanding officers.*

Summing up the foregoing remarks on the metacentric method of estimating stability, it may again be stated that the metacentre is simply a fixed point through which the buoyancy of a ship may be supposed to act for all angles of inclination up to 10 degrees or 15 degrees in vessels of ordinary form. This is tantamount to saying that the metacentre may be taken as a hypothetical point of suspension for a ship in order to estimate the righting moment when she is steadily heeled to any angle within the limits named, as indicated on Fig. 34, p. 83.

For vessels of unusual form—as, for example, the monitor type with extremely low freeboard—the metacentric method cannot be trusted for such considerable inclination as in ordinary types. On the other hand, there are certain forms for which the metacentric method applies to even greater inclinations, or even for all possible inclinations. The well-known cigar-ships exemplify the last-named condition. All transverse sections of these ships are circles. Suppose Fig. 41 to represent the section containing the centre of buoyancy B for the upright position, WL being the water-line. Then obviously for any inclined position (such as is shown in Fig. 42, where the

FIG. 41.

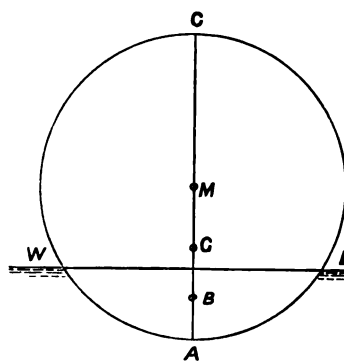
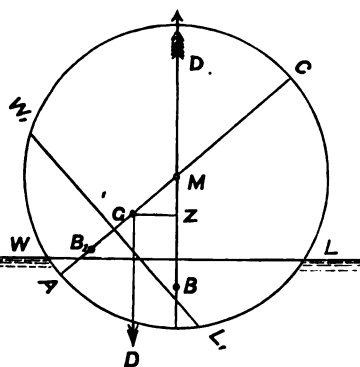

FIG. 42.



original water-line is marked W_1L_1 , and the original centre of buoyancy B_1 the new centre of buoyancy B determines the vertical line of action (BM) of the buoyancy, which intersects the original

* See a paper by Mr. A. Denny, on "The Practical Application of Stability Calculations": *Transactions of the Institution of Naval Architects for 1887.*

vertical (B_1M) in the centre (M) of the cross-section. Hence, if G be the centre of gravity, we shall have for any angle of inclination α ,

$$\text{Moment of statical stability} = D \times GM \sin \alpha.$$

In other words, the cigar-ship may be regarded as a pendulum turning about the point of suspension M throughout the whole range of its transverse inclinations; instead of limiting that comparison to 15 degrees, as is done for ordinary ships.

The conditions of stability of a wholly submerged or submarine vessel are as simple as those of the cigar-ship. In Fig. 43 a cross-

section of such a vessel is given; B is the centre of buoyancy, and for a position of equilibrium B and the centre of gravity G must lie in the same vertical line. When this condition is unfulfilled (as in the diagram), the weight and the buoyancy form a mechanical couple, just as in the case of a ship having a part of her volume above water. For the submarine vessel, however, inclination produces no change in either the

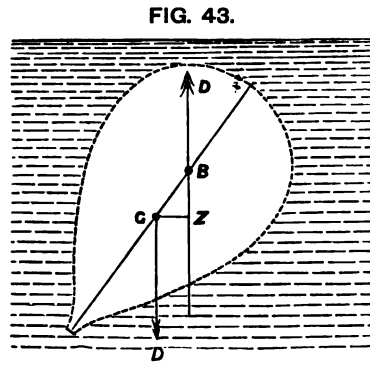

form of the displacement or the position of the centre of buoyancy; for all positions the buoyancy acts upwards through the same point B , and the total weight downwards through the centre of gravity G . Consequently stable equilibrium is only possible when the centre of gravity lies (as in the diagram) below the centre of buoyancy; for obviously, if G were placed vertically above B , and the vessel were inclined ever so little, no position of rest could be reached until G was placed vertically below B . For wholly submerged floating vessels, therefore, the centre of buoyancy takes the place of the metacentre in vessels partially immersed, and for all angles of inclination (such as α)—

$$\text{Moment of statical stability} = D \times GB \sin \alpha.$$

It has been remarked above that experience is the best guide for naval architects in selecting the values of “metacentric heights” (GM , Fig. 34) for various classes of ships, when circumstances permit of such selection. The following information respecting the actual metacentric heights in different classes will be of interest. Taking, first, *war-ships*, two tables summarize the facts for armoured, protected, and unarmoured vessels respectively; and for the *fully laden* conditions. When the coals and consumable stores are not on board,

the change in metacentric height varies in different classes, being affected both by the character of the metacentric locus and by the manner in which the consumable weights were originally stored. In some cases there is practically no change in "stiffness" with consumption of coals, etc. This is true of armoured vessels like the *Inflexible*, with large proportions of the coal carried near the height of the load-line. It is also true in most classes of modern swift protected cruisers in the Royal Navy, and this practical constancy in stiffness is advantageous. Other classes with lower stowage of coal, etc., lose in stiffness as they lighten to the extent of from 6 inches to 1 foot, or even more. Calculations are always made for the stiffness in the extreme load and light conditions, and often for intermediate conditions of coal expenditure.

The tables on p. 97 require few explanatory remarks. Experience has led to the common selection of metacentric heights of from $2\frac{1}{2}$ to 4 feet in vessels of war possessing moderate sail-power as well as steam-power. Such heights gave a fair amount of stiffness under sail, in association with good behaviour in rough water. As the speeds of war-ships have been increased, and sail-power has been either abolished or greatly diminished, the metacentric heights have also been diminished, especially in the cruiser classes. These heights now commonly vary from $1\frac{3}{4}$ to $2\frac{1}{2}$ feet, and this amount of stiffness is found sufficient for all manœuvring, while it favours steadiness at sea. In certain special classes of armoured ships, with limited lengths of the water-line protected by vertical armour, it has been deemed desirable to accept much larger values of the metacentric heights, in order to provide against possible losses of stability due to damage in action. These very stiff ships are not as steady gun-platforms as their predecessors with more moderate metacentric heights. The latest types of battle-ships are designed in accordance with the earlier models, and the anticipation that they would be steadier in consequence has been realized on service.

Merchant ships, especially cargo-carriers, as above explained, are subjected to considerable variations in the character and stowage of their cargoes, over which the designer has no control. Consequently, the stiffness of an individual ship may vary greatly on different voyages; and the stevedores who regulate the stowage, chiefly by practical rules deduced from experience, to a large extent control the stiffness of the laden ship. Under these circumstances it is not possible to give exact particulars of metacentric heights, such as have been given for war-ships. From facts recorded, it appears that in fully laden merchant steamers the metacentric heights sometimes fall as low as 6 or 8 inches; frequently they lie between $1\frac{1}{2}$ and 3 feet, and occasionally have still higher values.

Armoured ships.	Metacentric height (GM).
	Feet.
A. Sail-power and steam—	
1. Converted frigates (formerly two-deckers): <i>Prince Consort</i> class, Royal Navy; <i>Gloire</i> class, French Navy	6 to 7
2. <i>Warrior</i> and <i>Minotaur</i> classes, Royal Navy; <i>Flandre</i> class, French Navy	4 to 4½
3. Central-battery ships: <i>Bellerophon</i> , <i>Hercules</i> , <i>Alexandra</i> , Royal Navy; <i>Alma</i> class, French Navy	2½ to 3½
4. Ocean class, French Navy	1¾ to 2½
B. Steam-power only—	
5. Seagoing turret-ships, Royal Navy (moderate freeboard): <i>Devastation</i> , <i>Dreadnought</i> , <i>Tra-</i> <i>falgar</i>	3½ to 4½
6. Barbette-ships, Royal Navy: <i>Admiral</i> and <i>Im-</i> <i>perieuse</i> classes	4¾ to 6
7. Barbette-ships, Royal Navy and French Navy: latest types	2¾ to 3¾
8. Central citadel turret-ships, Royal Navy: <i>Inflex-</i> <i>ible</i> and <i>Ajax</i> classes	5½ to 8¼
9. Coast-defence ships: <i>Glatton</i> , Royal Navy; <i>Belier</i> , French Navy	6 to 8
10. American type of coast-defence monitor	About 14

Unarmoured and protected ships.	Metacentric height (GM).
	Feet.
A. Sail-power and steam (single screws)—	
1. Obsolete screw line-of-battle ships	4½ to 6½
2. Obsolete screw frigates and corvettes	4 to 5
3. Wood and composite corvettes and sloops (types still on service)	2¾ to 4
4. Wood and composite gun-vessels and gunboats	2¼ to 3
5. Swift frigates and corvettes: <i>Inconstant</i> and <i>Active</i> classes, Royal Navy; <i>Tourville</i> and <i>Seignelay</i> classes, French Navy	2½ to 3
B. Steam only, or very light rig (twin screws)—	
6. Swift despatch-vessels (unprotected): <i>Iris</i> class.	2¾ to 3
7. Protected cruisers of recent construction, Royal Navy: <i>Mersey</i> , <i>Medea</i> , and <i>Apollo</i> classes; and unprotected torpedo cruisers: <i>Archer</i> class	1¾ to 2½
8. Sloops and small protected cruisers, torpedo gun-boats	2 to 2½
9. Coast-defence and river-service gunboats (unpro- tected)	7 to 12
10. Troop and store ships	2 to 3
11. Tugs and small vessels not seagoing	1 to 2
12. Torpedo-boats (1st class), earlier types	0·8 to 1¼
" " later types	1¼ to 2
13. " (2nd class), earlier types	0·4 to 0·8
" " later types	0·8 to 1·0

Not a few instances have occurred where, with heavy dead-weight cargoes improperly stowed, vessels have been made unduly stiff, and heavy rolling at sea has resulted with serious damage in some cases. On the other hand, large ocean-going passenger-steamers with metacentric heights of from 1 to $2\frac{1}{2}$ feet have gained high reputations for steadiness. For cargo-carriers, homogeneous cargoes, such as grain, are usually considered to favour stiffness least with a given dead-weight. Under this condition cargo-steamers have been found to possess metacentric heights of $\frac{7}{10}$ to $\frac{8}{10}$ of a foot; others have had $1\frac{1}{2}$ to 2 feet; but some types cannot carry such cargoes without ballast, although they require no ballast in actual service with miscellaneous cargoes.

Sailing merchant ships, when laden, must possess sufficient stiffness to stand up under their canvas, and this fact furnishes a valuable practical test of the *minimum* amount of metacentric height which is permissible. It is stated on good authority that with ordinary stowage these vessels may possess metacentric heights of 3 to $3\frac{1}{2}$ feet. On the other hand, it must be noted that the dead-weight carried by such vessels frequently exceeds two-thirds of their load displacements; so that differences in stowage may produce very considerable variations in stiffness. As a rule a sailing-ship laden with a homogeneous cargo would not possess a metacentric height exceeding 1 foot or 18 inches; and would require to carry ballast, or dead-weight serving as ballast, low down in the hold in order to obtain sufficient stiffness. There are, however, exceptions to this rule, in which metacentric heights of 2 to 3 feet can be secured with a homogeneous cargo, and without ballast; in order to increase the stiffness even in such vessels some dead-weight or ballast would usually be carried, although less in proportion than in ships of ordinary form. The opposite extreme to a homogeneous cargo is, of course, that where the cargo consists of heavy materials, such as pig-iron, rails, etc.; and if care is not exercised in stowing such cargoes excessive stiffness may be obtained, causing heavy rolling at sea.

The comparatively large metacentric heights of the obsolete classes of sailing war-ships doubtless tended to increase their rolling; but these vessels had to fight under sail, and had large sail-power, so that a considerable degree of stiffness was essential, in order to prevent excessive heeling and consequent inefficiency of the guns fought on the leeward broadside. Only a few experiments were made to determine the actual stiffness of these vessels. The best information available gives them metacentric heights of from $4\frac{1}{2}$ to $6\frac{1}{2}$ feet when fully laden, and about $1\frac{1}{2}$ to 2 feet less when light. Considerable weights of ballast and water in tanks were carried

permanently to give this stiffness. As much as one-seventh to one-eighth of the total displacement was often assigned to water and ballast, and sometimes a large proportionate weight of ballast was carried.

In sailing-yachts metacentric heights of 3 to 4 feet are common; there are, however, some classes of broad shallow yachts in which the corresponding heights rise to 8 or 10 feet. Small yachts of from 3 to 5 tons (Thames tonnage) have metacentric heights, in some instances, of from $1\frac{3}{4}$ to $2\frac{1}{4}$ feet. Yachts possessing steam as well as sail power, and having good reputations as sea boats, have been found by experiment to have metacentric heights of 3 to 4 feet. Examples occur where the corresponding heights are only about 2 feet.*

The systematic experimental determination of the metacentric heights of war-ships belonging to the Royal Navy may be said to date from 1870. Prior to that time many experiments were made on typical ships, but the practice was not general. In private shipyards similar experiments were but rarely conducted until a much later date. Now many leading firms regularly make inclining experiments, and there is reason to hope that the practice will become general. Already a great mass of information has been obtained, and constant additions are being made thereto. Most of this information is naturally in the private records of shipowners and shipbuilders, although much has been published. From the designer's point of view, interest chiefly centres in the condition of merchant ships when floating light with no weights on board other than those belonging to hull, equipment, or machinery. Having ascertained the vertical position of the centre of gravity for this condition, it is an easy matter to approximate to the change in that position produced by putting any weights on board, and thus to estimate the "metacentric height" for a given stowage of dead-weight. This will appear more clearly from the explanations given on p. 117. Confining attention for the present to the *light condition* of merchant steamers, the following table will be of some interest, containing as it does results deduced from experiments made to determine the actual stiffness of a number of vessels of various classes.†

* See Mr. Dixon Kemp's "Yacht Architecture," for details of experimental results.

† For many of the facts in this table the author is indebted to gentlemen connected with some of the leading private shipbuilding firms—including Messrs. Laird, of Birkenhead; Messrs.

Denny, of Dumbarton; Messrs. A. and J. Inglis, of Glasgow; Messrs. R. Napier and Sons, of Glasgow. The remaining examples are taken from the results of inclining experiments made on mercantile steamers bought into the Royal Navy.



TABULAR STATEMENT OF THE RESULTS OF INCLINING

Reference number.	Length between perpendiculars.		Breadth, extreme.	Depth from upper side of keel to top of upper-deck beam at side amidships (D).	Experimental data for ships floating light, with water in boilers, but no cargo or other dead-weight on board.						
	ft.	in.			ft.	in.	tons.	feet.	feet.	Ratio, $h : D$.	
1	440	0	46	0	36.25	13	2	4570	-1.0	22.5	.62
2	350	0	44	6	34.5	18	8	4240	1.2	20.5	.594
3	390	0	39	0	30.8	13	6	3200	-.7	17.9	.58
4	340	0	46	2	34.0	16	6	3140	2.3	20.0	.588
5	320	0	40	0	28.5	9	7	2110	2.9	18.0	.63
6	320	0	40	0	22.7	11	5	1900	5.2	15.8	.696
7	320	0	34	0	26.5	11	4	1880	-1.25	17.0	.64
8	313	0	33	6	25.5	11	6	1760	.2	15.4	.6
9	285	0	35	0	26.5	9	10	1610	2.1	14.85	.56
10	290	0	34	0	25.8	9	2	1530	1.5	14.9	.577
11	290	0	32	0	16.6	10	3	1410	2.4	12.7	.765
12	264	0	32	0	23.0	8	11	1240	1.5	14.5	.63
13	253	0	33	2	26.3	9	10	1130	2.0	14.1	.536
14	234	0	29	0	19.6	10	6	1100	1.5	11.2	.57
15	195	0	29	2	18.0	12	11	1040	1.3	12.0	.67
16	227	0	28	0	20.6	8	9	860	.7	11.9	.577
17	210	0	28	0	15.0	9	4	780	.83	11.5	.77
18	220	0	27	6	22.0	9	0	780	-.3	12.8	.58
19	220	0	30	0	22.5	8	3	750	1.8	12.7	.565
20	200	0	26	0	13.9	8	5½	630	1.8	10.4	.75
21	178	0	27	0	20.0	9	6	600	1.4	11.5	.575
22	125	0	20	0	9.5	4	9	180	3.2	7.4	.78
23	60	0	12	0	6.3	3	11	32	1.8	4.3	.68

It will be remarked from the table that there are very considerable differences in the stiffness, as well as in the vertical position of the centre of gravity (in relation to the total depth) of different ships. Many of these vessels are sufficiently stiff, when floating



EXPERIMENTS MADE ON VARIOUS TYPES OF MERCHANT STEAMSHIPS.

Reference number.	REMARKS.
1	{ Trans-Atlantic mail steamer; new type; cellular double bottom; large deck-houses; light rig.
2	{ Mail steamer (old type); good speed; good sail-spread; fore-castle, poop, and deck-houses; 180 tons of permanent ballast.
3	{ Cargo and passenger steamer; good speed; light rig; deck-houses and turtle covers at ends.
4	{ Same type as (2); with 75 tons of permanent ballast; deck-houses only.
5	{ Cargo and passenger steamer; good speed; light rig; poop and fore-castle; continuous double bottom.
6	{ Cargo and passenger steamer; good speed; light rig; awning deck; and heavy deck-houses.
7	{ Cargo steamer; moderate speed; light rig; turtle covers at end, and deck-houses; water-ballast tank above ordinary floor.
8	{ Passenger and cargo steamers; high speed; light rig; deck-houses.
9	{ Cargo steamer; moderate speed; light rig; fore-castle and deck-houses; continuous double bottom.
10	{ Ditto ditto ditto.
11	{ Passenger steamer (paddle-wheel); high speed; light fore-castle and full poop.
12	{ Cargo steamer; low speed; light rig; flush deck.
13	{ Ditto ditto.
14	{ Cargo and passenger steamer; moderate speed; light rig; fore-castle, poop, and deck-house.
15	{ Armed sloop; composite built; good speed; full rig; light armament; 150 tons of permanent ballast.
16	{ Cargo and passenger steamer; moderate speed; brig rig; awning deck and deck-houses above.
17	{ Cargo and passenger steamer; moderate speed; moderate rig; fore-castle, poop, and deck-houses.
18	{ Cargo steamer; moderate speed; light rig; deck-houses.
19	{ Ditto ditto.
20	{ Cargo and passenger (Channel service); good speed; light rig; poop, fore-castle, and deck-house.
21	{ Cargo steamer; low speed; light rig; deck-houses; 80 tons of ballast.
22	{ Cargo boat; low speed; light rig; fore-castle and raised quarter-deck.
23	{ Steam-launch.

light, to permit of their being shifted from berth to berth in port without requiring ballast. Others are so stiff that they might, as far as this quality is concerned, be safely trusted from port to port with little or no ballast. Others, on the contrary, require to be ballasted

in order that they may stand up without cargo; although when fully laden they may have sufficient metacentric heights without ballast. Some of the steamers in this last category are worked without ballast, coals being shipped as cargo is discharged in order to preserve sufficient stiffness; while others use water-ballast as the most convenient method of meeting the requirements of the case, and others of older type require rubble-ballast, or pig-iron, to be put on board as cargo is discharged. The explanatory notes attached to the table will enable the effect of forecastles, poops, and deck-houses upon the vertical position of the centre of gravity to be traced, as well as the influence of differences in the rig or structure of various ships. For purposes of guidance in design fuller details would be required, but for the present purpose the particulars given will suffice.

Another table (pp. 104, 105) contains results of experiments made on several classes of sailing-ships, to determine their metacentric heights and the positions of the centres of gravity. For the obsolete classes of war-ships both the load and light conditions are given; for the merchant ships only the light condition; and for yachts only the load condition, the weight of consumable stores, etc., carried in them being comparatively small.*

Practical Applications of Metacentric Stability.—Attention will next be directed to some of the more important practical applications of the metacentric method of estimating stability for transverse inclinations. The first to be noticed will be the *inclining experiment*, by means of which the vertical position of the centre of gravity of a ship is ascertained after her completion. In designing a new ship the naval architect makes an estimate for the position of the centre of gravity, and with care can secure a close approximation to accuracy. On the other hand, a lengthy and laborious calculation is required in order to fix the position of the centre of gravity accurately; and it is now generally agreed that, for purposes of verifying estimates, as well as of obtaining trustworthy data for future designs, inclining experiments are desirable. These experiments are simple as well as valuable, and it may be of service to indicate the manner in which they are usually conducted in ships of the Royal Navy.

The ship being practically complete—with spars on end, the bilges dry, the boilers either empty or quite full, no water in the

* This table is compiled from information given in the "Papers on Naval Architecture" (1827-33); "Reports," by Messrs. Read, Chatfield, and Creuze (1842-46); "Reports on Masting," made to the Committee of Lloyd's Register (1877); and (for yachts) chiefly from

Mr. Dixon Kemp's publications. Special thanks are due to Mr. John Inglis and the late Mr. Henry Laird for facts respecting merchant ships. The particulars for the *Sunbeam* are published with the permission of Lord Brassey.



interior free to shift, and all weights on board well secured so that they may not fetch away when she is inclined—is allowed to come to rest in still water. A calm day is desirable, but if there be any wind, the ship should be placed head or stern to it and allowed to swing free, the warps being so led that they may practically have no effect in resisting the inclination of the ship. For the purpose of producing inclination, piles of ballast are usually placed on the deck (see *W, W*, Fig. 44), being at first equally distributed on either side, but in some cases the guns of a ship have been traversed from side to side instead of using ballast. Two or three long plumb-lines are hung in the hatchways, and by means of these lines the inclinations from the upright are noted. All being ready, and the ship at rest, the positions of the plumb-lines are marked, and the draught of water is taken. The position of the metacentre corresponding to this draught can then be ascertained by calculation from the drawings. Next, a known weight of ballast (*W*, Fig. 44) is moved across the deck through a known distance. The vessel becomes inclined, and after a short time rests almost steadily in this new position; in other

FIG. 44.

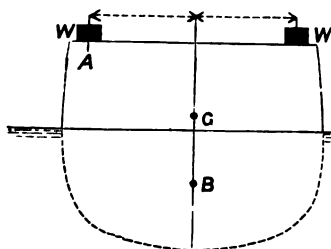
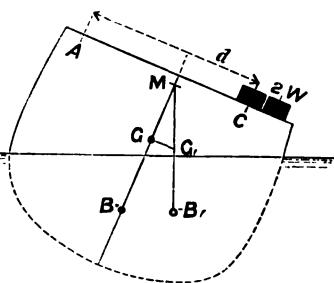

FIG. 45.



words, is once more in *equilibrium*, as shown in Fig. 45. Consequently, for this new position, the metacentre *M* must be vertically above the new centre of gravity (G_1); for obviously the shift of ballast has moved the centre of gravity of the whole ship through a certain distance GG_1 parallel to the deck, and it is this movement of the centre of gravity that produces the inclination. Suppose α to be the angle of inclination noted on the plumb-lines when the ballast *W* has been moved through the transverse distance d . Then (since GG_1 is perpendicular to GM) we have—

$$GG_1 = GM \tan \alpha; \text{ or } GM = GG_1 \cot \alpha.$$

And if GG_1 can be determined, the distance of the centre of gravity below the known position of the metacentre can be found, and the true vertical position of the centre of gravity is ascertained for the experimental condition of the ship. Any subsequent corrections

TABULAR STATEMENT OF THE RESULTS OF INCLINING

Reference number.	Length between perpendiculars.	Breadth, extreme.	Depth from upper deck at side amidships. (See note.) (D).	Mean draught.	Displacement.	Meta-centric height.	Height of centre of gravity. (See note.) (h)	Ratio, h : D.
War-ships—								
	feet.	feet.	feet.	t. in.	tons.	feet.	feet.	
1	113	35·4	19·2	15 4	670	4·85	15·4	·8
2	100	30·9	15·4	13 8	495	4·77	12·2	·79
3	100	32·3	17·7	13 9	475	5·65	12·5	·7
	—	—	—	12 9	405	4·23	13·5	·76
4	141	38·8	27·5	16 7	1075	4·5	18·0	·65
	—	—	—	15 0	875	2·5	19·9	·72
5	131	40·6	27·5	17 4	1055	6·2	17·6	·64
	—	—	—	16 0	890	4·3	19·3	·7
Merchant ships (light condition)—								
6	273	43·1	25·4	9 7	1440	2·7	20·1	·79
7	263	38·3	24·6	9 2	1100	·75	19·5	·79
8	225	37·5	24·6	9 3	1010	-1·5	21·0	·85
9	217	35·5	22·7	8 7	860	·0	18·8	·83
10	215	35·0	22·3	9 0	810	-·5	18·4	·825
11	148	26·9	15·0	6 5	290	2·0	12·2	·81
Yachts—								
12	86·0	18·7	14·2	10 9	160	3·5	7·5	·528
13	100·0	16·7	13·2	9 4	158	3·3	5·7	·43
14	90·5	18·9	14·4	10 1	155	3·4	8·2	·57
15	95·75	19·3	13·2	10 10	150	3·7	8·4	·64
16	81·25	20·6	12·3	9 5	128	4·0	8·9	·72
17	79·5	17·3	13·7	10 6	115	3·0	8·4	·62
18	103·0	20·8	12·9	9 7	135	4·0	8·2	·64
19	154·75	27·5	17·3	13 0	576	3·45	12·4	·72

* For the vessels named in this table, except the yachts, the depth (D) is The height, *h*, of the centre of gravity is also estimated above the top of this draught and the least freeboard; and the height of the centre of gravity is measured mean draught. The lengths and breadths extreme for the yachts are taken at the

consequent on the removal of the ballast, addition of water in the boilers, or other alterations in the condition of the ship when fully equipped, can be easily made.

The value of GG_1 can be readily estimated by means of a simple

EXPERIMENTS, ETC., MADE ON VARIOUS CLASSES OF SAILING-SHIPS.*

Reference number.	REMARKS.
1	18-gun corvette of 1832; load condition.
2	18-gun sloop of 1830; load condition.
3	Brig; load condition.
	Brig; light condition.
4	Frigate; load condition.
	Frigate; light condition.
5	Frigate; load condition.
	Frigate; light condition.
6	Full ship rig; estimate by Lloyd's surveyors; registered length and breadth.
7	Ditto ditto ditto.
8	{ Poop, forecastle, and exceptionally heavy rig; result of inclining experiment.
9	{ Poop, forecastle, and full ship-rig; result of inclining experiment.
10	{ Forecastle, deck-house, and full ship-rig; ditto.
11	{ Three-masted schooner; estimate by Lloyd's surveyors; registered length and breadth.
12	<i>Miranda</i> , schooner; 78 tons of ballast
13	<i>Jullanar</i> , yawl; 79.5 " "
14	<i>Seabelle</i> , schooner; 73 " "
15	<i>Florinda</i> , yawl; 54 " "
16	<i>Rose of Devon</i> , yawl; 57 " "
17	<i>Kriemhilda</i> , cutter; 54 " "
18	Revenue cutter; 48 " "
19	{ <i>Sunbeam</i> , three-masted schooner; 75 tons of ballast; Lord Brassey's yacht, with good steam-power.

The stability of these vessels has been fully investigated by Mr. Dixon Kemp.

reckoned to the top of the projection of keel, false keel, etc., beyond the garboards. projection. For the yachts, the *total depth* is taken; i.e. the sum of the mean from a line drawn parallel to the load-line, at a distance below it equal to the load-line.

calculation, the character of which may be better seen by means of an illustration. A uniform lever (Fig. 46) is loaded with two weights, W, placed at equal distances from the middle; it will then balance upon a support placed at the middle (G) of the length.

Now let one of the weights W be moved to the opposite end (as in Fig. 47) through a distance d . Obviously the point about which

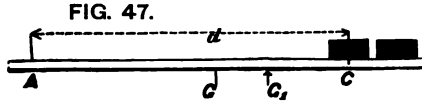
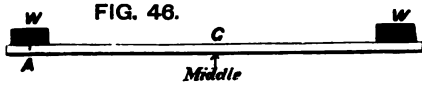

the lever will balance (that is, the *centre of gravity* of the lever and the weights W) will no longer be at the middle, but at some point (G_1 , Fig. 47) to the right of the middle. If D be the total weight of

the lever and the weights it carries, by the simplest mechanical principle it follows that—

$$D \times GG_1 = W \cdot d; \text{ whence } GG_1 = \frac{W \cdot d}{D}$$

What is true in this simple case is true also for the ship; the line GG_1 , in Fig. 45, joining the old and new positions of the centre of gravity, must be parallel to the deck-line, across which the weight W is moved, and the above expression for GG_1 holds. Hence, since—

$$GM = GG_1 \cdot \cot \alpha, \text{ while } GG_1 = \frac{W \cdot d}{D}$$

it follows that—

$$GM = \frac{W}{D} \cdot d \cot \alpha,$$

an equation fully determining the position of the centre of gravity G in relation to the known vertical position of the metacentre M , ascertained by calculation from the drawings.

As an example, suppose a ship for which the displacement (D) is 4000 tons to have 60 tons of ballast placed upon her deck, 30 tons on each side. When the 30 tons (W) on the port side is moved to starboard through a transverse distance of 40 feet (d), the vessel is observed to rest at a steady heel of 7 degrees from her original position of rest. Then, from the above expression—

$$\begin{aligned} GM &= \frac{W}{D} \cdot d \cot \alpha = \frac{30}{4000} \times 40 \times \cot 7^\circ \\ &= \frac{3}{10} \times 8.144 = 2.43 \text{ feet.} \end{aligned}$$

In practice it is usual to subdivide the ballast on each side into two equal piles, and to make four observations of the inclinations produced by—

- (1) Moving one pile of ballast from port to starboard;
- (2) Moving second pile of ballast from port to starboard.

These two piles having been restored to their original places, the plumb-lines should return to their first positions, unless some

weights other than the ballast have shifted during the inclinations. Then two other inclinations are produced and noted by—

(3) Moving one pile of ballast from starboard to port ;

(4) Moving second pile of ballast from starboard to port.

The results of observations (1) and (3), (2) and (4) should agree respectively, if the four piles of ballast are of equal weight, and if the distance d is the same for all; the inclinations in (2) and (4) should be about twice those in (1) and (3). The values of GM are deduced from each experiment, and the *mean* of the values is taken as the true value of the metacentric height at the time of the experiment. Thence it is easy to deduce the metacentric height for the vessel in her fully equipped seagoing condition or in any other assigned condition.

The reason for great caution in preventing any motion of weights on board, other than the ballast, during the inclining experiment, will appear from the expression given above for the motion (GG_1) of the centre of gravity. The moment due to the motion of the ballast Wd is comparatively small; in the above example, which is a fair one—

$$Wd = 30 \text{ tons} \times 40 \text{ feet} = 1200 \text{ foot-tons,}$$

and—

$$GG_1 = \frac{1200}{4000} = \frac{3}{10} \text{ foot only.}$$

Now, if other weights, and particularly free water in the bilges, shift as the ship inclines, their aggregate moments may bear a considerable proportion to $W \cdot d$, and so the estimated value of GG_1 may be less than the true one, if no account is taken of the shift of water. For example, 5 tons of water free to shift 30 feet in a transverse direction would have a moment (5×30) of 150 foot-tons, or no less than *one-eighth* that of the ballast, and if its effect were unobserved through carelessness, the motion of the ballast would be credited with producing an inclination about *one-eighth greater* than it could produce if acting alone. In the foregoing example, if such an error had been made, instead of writing $Wd = 1200$ foot-tons, it should have been $1200 + 150 = 1350$ foot-tons; so that the metacentric height would have been—

$$GM = \frac{1350}{4000} \times \cot 7^\circ = \frac{27}{80} \times 8.14 = 2.75 \text{ feet.}$$

In performing inclining experiments, too great care cannot, therefore, be taken to ensure that no other weights shall shift than those made use of to produce the inclinations.

Various proposals have been made for enabling the actual metacentric heights of laden merchant ships to be experimentally

determined by commanding officers, in any condition of lading. The principle of all such proposals is that of the inclining experiment just described; and to produce inclinations, instead of shifting ballast, a fixed quantity of water, measured by filling a tank or boat, is used at a given distance from the middle line. The moment producing inclination being thus made a constant, it is necessary, in order to determine the metacentric height, to know the displacement for the water-line at which the ship is floating, and to note the angle of heel produced by filling the boat or tank. By means of tables or diagrams prepared by the shipbuilder and placed in the hands of the captain, the latter is to be freed from the necessity for any calculations. Up to the present time these plans have not been extensively adopted; they would add much to our information if carried out with sufficient care, but under working conditions there are often considerable difficulties in the way of satisfactory experiments.*

A second useful application of the metacentric method is found in a practical rule for estimating the angle of heel produced by moving a weight athwartships in a ship. Referring to the formula—

$$GM = \frac{W}{D} d \cot \alpha,$$

we may arrange it as follows:—

$$\tan \alpha = \frac{W \cdot d}{D \cdot GM}$$

and for the case under consideration assume that all the quantities on the right-hand side of the equation are known, the value of $\tan \alpha$ being thus determined. As an example, suppose a weight (W) of 5 tons to be moved horizontally a distance (d) of 30 feet athwartships in a ship of 1500 tons' displacement (D), having a metacentric height of 3 feet; then—

$$\tan \alpha = \frac{5}{1500} \times \frac{30}{3} = \frac{1}{30}$$

$$\alpha = 2^\circ \text{ (nearly).}$$

This rule is of service in approximating to the heel produced by transporting guns or heavy weights from side to side on a deck or platform which is nearly horizontal athwartships.

When the vertical positions of weights already on board a ship are changed, the result is simply a change in the position of the

* For details see Mr. Taylor's paper on a Stability Indicator in the *Transactions* of the Institution of Naval Archi-

ects for 1884; and a paper by Mr. A. Denny in the *Transactions* for 1887.

centre of gravity of the ship; for obviously the displacement and position of the metacentre remain unaltered, since there is no addition or removal of weights. The shift of the centre of gravity can be readily estimated by the rule already given. Suppose the total weight moved to be w , and the distance through which it has been raised or lowered to be h , then, if GG_1 be the rise or fall in the centre of gravity—

$$GG_1 = \frac{w \cdot h}{D}$$

where D is the total displacement of the ship. If GM was the original height of the metacentre above the centre of gravity, for an angle α within the limits to which the metacentric method applies—

Original moment of statical stability = $D \times GM \times \sin \alpha$.

Altered moment of statical stability = $D (GM \pm GG_1) \sin \alpha$.

The alteration is an increase when the weights are lowered; a decrease when the weights are raised. As an example, take the case of a ship of 6000 tons' displacement, having a metacentric height of $3\frac{1}{4}$ feet; and suppose spars, etc., weighing together 10 tons, to be lowered 70 feet. Then—

$$GG_1 \text{ (fall of centre of gravity)} = \frac{10 \times 70}{6000} = \frac{7}{60} \text{ foot.}$$

Original moment of statical stability = 19,500 foot-tons $\times \sin \alpha$.

$$\begin{aligned} \text{Altered moment of statical stability} &= 6000 \left(3\frac{1}{4} + \frac{7}{60} \right) \sin \alpha \\ &= 20,200 \text{ foot-tons} \times \sin \alpha. \end{aligned}$$

Another case where weights already on board a ship are shifted, involves a motion of the centre of gravity of the weights moved in both the horizontal and the vertical directions. For example, when coal or grain cargoes are carried, and a vessel is steadily heeled under sail to one side for a considerable period, the cargo may shift to leeward. In such cases, if the inclining forces were removed, the ship would obviously not return to the upright, but would rest in an inclined position, which can be very simply determined. Let Fig. 48 illustrate this case. WL is the load-line; M is the metacentre corresponding thereto. Suppose, when the ship is upright in still water, the grain in a partially filled hold has ab for its surface; and that after she has been steadily heeled for a considerable time that surface changes to cd . Let ab and cd intersect in e . Then, what has happened is this: a wedge-shaped mass of grain originally at aec , of known weight W , and having its centre of gravity at g_1 , has been shifted into the position bed with its centre of gravity at g_2 .

Join g_1g_2 . Then, as explained above, if G_1 be the centre of gravity of the ship and cargo before any shift took place, its new position

FIG. 48.

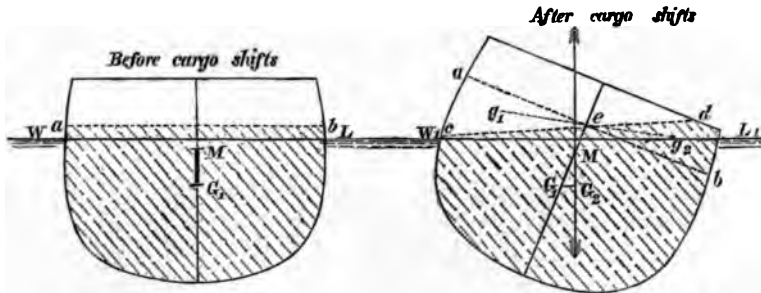

G_2 will be found on a line G_1G_2 drawn parallel to g_1g_2 ; and we must have—

$$G_1G_2 = \frac{W}{D} \cdot g_1g_2$$

Now, if the inclining forces are supposed to be removed, the ship will find her position of equilibrium, when the new position G_2 of the centre of gravity lies vertically below the metacentre M . And since two sides of the triangle G_1MG_2 (G_1M and G_1G_2) are given, as well as the angle MG_1G_2 , that triangle is fully known, and the angle G_1MG_2 can be ascertained. This will be the angle of heel required.

As an example, take the case of a ship of 3200 tons' displacement, which, when fully laden with a cargo of coals, has a metacentric height of $2\frac{1}{2}$ feet. Suppose 80 tons to be shifted so that its centre of gravity moves 20 feet transversely, and 4 feet vertically. Then the corresponding transfers of the centre of gravity of ship and cargo will be given by the equations—

$$\text{Horizontal motion} = \frac{80 \times 20}{3200} = \cdot 5 \text{ foot.}$$

$$\text{Vertical rise} = \frac{80 \times 4}{3200} = \cdot 1 \text{ ,,}$$

The angle of heel in this case would be given with quite sufficient accuracy by the equation—

$$\tan \alpha = \frac{\text{horizontal transfer of centre of gravity}}{\text{original metacentric height}} = \frac{\cdot 5}{2\cdot 5} = \frac{1}{5}$$

or $\alpha = 11\frac{1}{3}^\circ$ (nearly).

If the vertical rise in the centre of gravity had been greater, the more accurate method of determining the heel would have been

applied. In practice precautions are taken to limit the possible transverse shift of cargoes. Shifting boards, or longitudinal partitions, are commonly fitted in grain-laden ships; and instead of being free to move across the full breadth, as assumed in Fig. 48, the upper part of the cargo can move only through the distance between the adjacent partitions and the sides. The movement of the common centre of gravity of ship and cargo and the resultant heel of the ship are thus diminished.

Water-ballast is now extensively used, especially in cargo-steamers. Cellular double bottoms or special tanks situated below the turn of the bilge are usually constructed to receive such ballast; and arrangements are made for readily filling the ballast spaces, or for pumping them out. It is important for purposes of stability that ballast compartments should be *completely filled*. The weight of water contained in them may then be treated as if it were solid ballast, since it cannot shift as the ship heels. If ballast compartments are only partially filled, and the water contained in them can shift transversely, or has a *free surface*, this transverse shift may, and often does, produce a reduction in stability, or an increase in heel, similar to that above described for shifting cargo. Whereas the surface of cargoes such as grain, coals, etc., will stand at a considerable "slope to the horizon, water will always rest with its free surface horizontal when a ship has settled to a steady heel. Cases arise in practice where caution has to be exercised during the admission or pumping out of water-ballast, when ships are in a condition of lading which gives them very small metacentric heights; and this is especially true when external forces, such as wind-pressure or wave-motion, tend to produce transverse inclinations.

When liquid cargoes, such as oil, are carried, precautions are also necessary under some conditions, and it may be well to illustrate this point briefly. For simplicity take first the case of a prismatic vessel, whose uniform cross-section when upright is illustrated in Fig. 49. In the first diagram the vessel is upright; W_1L_1 is the load-line; w_1l_1 , the surface of the contained liquid, which occupies a length of c feet. M is the metacentre corresponding to W_1L_1 , and G_1 the common centre of gravity of ship and lading (including the liquid) when the vessel is upright. Suppose the liquid to weigh x tons per cubic foot, and, as a first condition, to be free to shift across the *whole breadth* of the hold w_1l_1 when the ship inclines. Let the whole breadth be called $2b$; so that sw_1 or sl_1 (the half-breadth) is b feet. Fig. 50 shows the vessel inclined to a small angle α (circular measure used) within the limits to which the metacentric method applies. If D is the weight of ship and lading in tons, and the

liquid were solidified in the position shown in Fig. 49, then as above explained—

$$\begin{aligned} \text{Righting moment (liquid solidified)} &= D \times \overline{GZ} \\ &= D \times GM \sin \alpha \text{ (foot-tons).} \end{aligned}$$

When the liquid is free to shift, at the inclination α its surface (w_2l_2) will be horizontal; and for small inclinations will intersect the original surface (w_1l_1) at or near the middle line (s), as shown in Fig. 50. The transfer due to this shift is represented by the

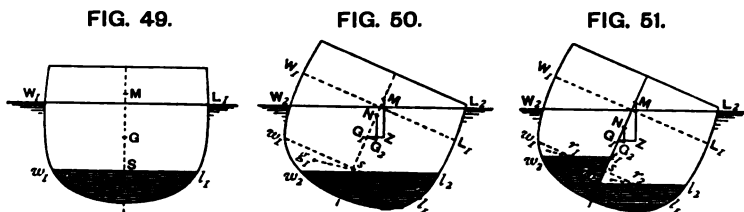

movement of a wedge-shaped mass w_1sw_2 into the position l_1sl_2 . Let v = volume of this mass (cubic feet); g_1 be the centre of gravity of w_1sw_2 , and g_2 that of l_1sl_2 . Then the transfer involves a movement of the common centre of gravity of ship and lading from G_1 to G_2 along a line parallel to g_1g_2 , and the equation holds—

$$D \times \overline{G_1G_2} = v \times \overline{g_1g_2} \times x.$$

To determine the value of G_1G_2 it is therefore necessary to determine the value of $v \cdot g_1g_2$, and this is very simply done by calculation. When G_2 has been fixed, the righting couple is represented by the buoyancy D acting vertically upwards through the metacentre M , and the total weight D acting vertically downwards through G_2 . For small angles of inclination G_1G_2 is practically horizontal, so that, as compared with the righting moment with liquid solidified, the loss due to transfer when liquid is free to move is expressed by—

$$\begin{aligned} \left. \begin{array}{l} \text{Decrease in righting moment due to} \\ \text{motion of liquid} \end{array} \right\} &= D \times G_1G_2 \\ \left. \begin{array}{l} \text{Actual righting moment for inclina-} \\ \text{tion } \alpha, \text{ with free liquid} \end{array} \right\} &= D \times \overline{G_2Z} \\ &= D \times \overline{NM} \sin \alpha. \end{aligned}$$

In other words, the presence of free liquid is equivalent to a reduction in metacentric height from G_1M to NM .

For the prismatic vessel in Fig. 50 the following values are practically correct when α is small:—

$$\begin{aligned} \text{Sectional area of wedges } w_1s_1w_2 \text{ or } l_1s_1l_2 &= \frac{1}{2}b^2 \cdot a. \\ \text{Distance } sg_1 = sg_2 &= \frac{2}{3}b. \\ \text{Distance } g_1g_2 &= \frac{4}{3}b. \end{aligned}$$

Hence—

$$v \times g_1g_2 = \frac{1}{2}b^2a \times c(\text{length}) \times \frac{4}{3}b = a \times \frac{2}{3}b^2c = a \cdot I.$$

As explained on p. 86, the expression $\frac{2}{3}b^2c$ is the “moment of inertia” of the free liquid surface w_1l_1 about its middle line s . If the vessel, instead of being prismatic longitudinally, with b constant, had varying values of b at different points of the length c , for an element of length, the expressions for volume and moment would be identical with those given above. Consequently it is a general rule that for small angles—

$$\left. \begin{aligned} \text{Decrease in righting} \\ \text{moment} \end{aligned} \right\} = D \times G_1G_2$$

= weight per cubic foot of liquid \times circular
measure of angle of inclination \times moment
of inertia of free liquid surface about its
middle line.

Next, take the case of our prismatic vessel, and suppose a partition-bulkhead built at the middle line, so that the liquid, in adjusting its surface to the horizontal for a small angle of inclination, can only move within the limits of half the breadth w_1l_2 . Fig. 51 illustrates the case. Taking one side, the original free surface w_1s for the upright position changes to w_2s_1 for the inclination α ; and these intersect at r_1 , the middle line of w_1s . It will be readily seen that the wedge-shaped mass $w_1r_1w_2$, which is shifted into the position t_1r_1s , has a weight only *one-fourth* of the mass transferred when there is no middle-line bulkhead; and the transverse movement of its centre of gravity is only *one-half* as great. The *moment* of the fluid moved on *one side* of the longitudinal bulkhead is only *one-eighth* that above estimated for the case where there is no partition. Allowing for a similar moment due to the transfer of the liquid on the other side of the bulkhead, the total moment is *one-fourth* that which occurs when there is no partition; and the value of G_1G_2 , measuring reduction in righting moment due to movement of liquid accompanying heeling, is correspondingly reduced.

It will be obvious from this illustration that with liquid cargoes it is most important to subdivide the holds by longitudinal as well as transverse partitions, and to take precautions in order to limit the possible transfer from side to side of the liquid as the vessel heels. If the hold-spaces are completely filled, and the liquid has no free surface, then it has already been explained that there is no reduction of stability, since there can be no shift.

The carriage of oil in bulk by seagoing steamships has been greatly developed in recent years, and has given greater importance to the foregoing considerations. Vessels specially built for the service have their holds subdivided by numerous transverse bulkheads, and in many cases by longitudinal middle-line bulkheads. Iron or steel decks form tops to the tanks. Provision has to be made for the expansion or contraction of the oil with changes of temperature. For this purpose cased-in spaces, known as "expansion trunks," are built above each compartment, and the oil not merely fills the under-deck spaces, but stands at a certain height in the trunks. These trunks, therefore, contain the only free surfaces of the liquid when the vessels are fully laden, and the movement with heeling or rolling is not such as to sensibly affect stability.* When oil-cargoes are being put on board or pumped out on port, and the holds are partially empty, the liquid has free surfaces, and its movement may produce considerable increase in the heeling originated by external forces or shift of weights on board. Care must be taken, therefore, in handling such vessels; and their minute subdivision makes this a comparatively easy matter.

The preceding investigation shows that when a vessel has free liquid in her interior, the stability is always less than if that liquid were solidified. Cases may occur, however, where the presence of free liquid in the bilges may not cause a reduction in the stability below that which a vessel would have without such liquid. As detailed investigations of ship-shaped forms cannot be given here, a simple example may be chosen to illustrate the principle. Turning to the cigar-shaped ship shown in Figs. 41, 42, p. 94, it will be seen that, if water is admitted to the bilge, its weight will act vertically through the line BM, whether the vessel is upright or inclined, and in the latter position will still remain symmetrically disposed about that line. The vessel would sink a little deeper, but the total buoyancy would still act along the line BM, and the stability would be unaltered. If a middle-line bulkhead were fitted, and the quantities of water on each side of it were equal when the vessel was upright, then when inclined the transverse shift would be less than without the bulkhead, and the stability would be greater than if

* Attention is here drawn simply to the *stability* of vessels carrying oil in bulk. There are many other special features deserving notice. For these, see papers by Mr. Martell and Mr. Eldredge in the *Transactions* of the Institution of Naval Architects for 1887, 1892, and 1893; by Messrs. Nicoll and Gravell in

vol. iii. of the *Transactions* of the North-East Coast Institution of Shipbuilders and Engineers; and by the late Professor Jenkins, dealing particularly with stability, in the *Transactions* of the Institution of Engineers and Shipbuilders in Scotland for 1889.

water had not been admitted. This case shows that for ship-shaped forms containing free liquid in the bilges much depends upon the amount and character of the subdivision, and on the form of the bilges.

When the skin of a ship is perforated, and one or more compartments placed in free communication with the sea, the conditions of statical stability are altered from those for the intact condition. Except in cases where watertight decks or platforms form tops to compartments, it may be said that the bilged compartment ceases to contribute any buoyant water-line area. In fact, taking the box-shaped vessel in Fig. 15 (p. 23) as an example, the effect of filling the compartment is to reduce the original water-line area by the area (fg) of the top of the compartment. Now, it has been explained above that the vertical position of the metacentre in relation to the centre of buoyancy depends upon the form and area of the buoyant water-line, or plane of flotation; any decrease, therefore, in area and moment of inertia must be accompanied by a consequent decrease in the height of the metacentre above the centre of buoyancy. But, on the other hand, the deeper immersion of the ship, when the compartment is bilged, leads to a rise in the position of the centre of buoyancy in the ship. The difference between this fall of the metacentre and rise of the centre of buoyancy measures the alteration in the metacentric height; and, for angles of heel up to 10 or 15 degrees in ships of ordinary form, will give a fair measure of the change of stiffness produced by filling the compartment. In some cases (and almost invariably where a midship compartment is damaged) the stability is decreased; in others it is increased. Without an investigation it is frequently not easy to determine the true character of the change. The difference between this case and that where water in the hold is not in free communication with the water outside lies principally in the fact that with a damaged bottom, if there be no horizontal watertight partition above the level of the whole, the water in the bilged compartment always maintains the same level as that of the water outside when the ship is held steadily in any position. Having, therefore, determined by this condition how much water will enter the damaged compartment, if we then conceive the bottom to be made good, and the compartment to contain that quantity of water, the statical stability of the ship may be estimated at any angle of inclination to which the metacentric method applies in the same manner as was explained above for a vessel having free water in the hold and the bottom intact.

The condition of a central-citadel ironclad, when her unarmoured ends above the shot-proof deck have been "riddled" by shot and shell, furnishes an illustration of the foregoing remarks. In the

Inflexible, for example, the central armoured citadel is 110 feet long; before and abaft it the protection of the ship is secured by a strongly plated deck, about $6\frac{1}{2}$ feet under water; and the spaces above this deck are minutely subdivided into watertight compartments, many of which are occupied by cork-packing, etc. Suppose the ship, with her sides intact, to float at the mean draught of 24 feet 7 inches, then her centre of buoyancy is about $13\frac{1}{2}$ feet above the keel-plates, and her transverse metacentre $17\frac{1}{2}$ feet above the centre of buoyancy. Supposing the unarmoured ends above the plated deck to be completely riddled, every space being thrown open to the sea, but the cork-packing to remain in place, the ship would sink about 2 feet deeper in the water, her centre of buoyancy would rise about 3 inches, and the metacentre would only be 11 feet above the centre of buoyancy. In other words, this serious damage to the ends would decrease the moment of inertia of the buoyant water-line area about 37 per cent. from its value in the intact condition. This fall in the metacentre reduces its height above the centre of gravity from $8\frac{1}{4}$ feet in the intact condition to 2 feet in the riddled condition.

When other than statical conditions come into operation, as, for instance, when a ship is rolling rapidly in a seaway, it is important to distinguish between the cases of free water contained within an undamaged skin and of water admitted to the interior by fracture of the bottom. And, further, it is necessary to distinguish between the cases of serious and slight damage to the bottom when dealing with the ship in motion, whereas no such distinction is necessary in discussing the stability for a steady heel. When held at a steady heel, free water in the hold will adjust its surface horizontally, even if there be some obstruction to the motion of the water towards this position of rest; but if the ship is in motion and changing her inclination rapidly, the element of time has to be considered, and the free water contained within an undamaged skin may not move rapidly enough as compared with the motions of the ship to maintain the horizontality of its surface. Similarly, when the ship is held at a steady heel, it does not make any difference whether a hole in the bottom of a bilged compartment is large or small; the final result will be that the compartment will be filled up to the level of the water outside. But the time taken in filling the compartment, or allowing any quantity of water to pass through the hole, of course depends upon the size and situation of the hole in the bottom; and therefore, when a ship is rolling, and the volume of any compartment up to the level of the water outside is constantly changing, there must be a marked difference between the stability in the cases of slight and serious damage to the skin.

Horizontal watertight platforms are of great service in maintain-

ing statical stability when the compartments they bound or subdivide are thrown open to the sea. Referring to Fig. 21, p. 30, when the compartment above the platform pq is filled, the stiffness of the box-shaped vessel is *less* than before the damage occurred. There is obviously a loss of buoyant water-line area, and the distance between the centre of buoyancy and the metacentre is consequently diminished. The centre of buoyancy rises owing to the deeper immersion, but this rise is more than counterbalanced by the fall of the metacentre. On the contrary, when the compartment below the platform pq is filled, there is no loss of buoyant water-line area, nor any decrease in the distance of the centre of buoyancy and metacentre. Consequently as the vessel sinks deeper by the entry of water the centre of buoyancy rises, and the vessel is *stiffer* when damaged than she was before water entered.

A ready rule for estimating the change in the metacentric stability or stiffness of a ship produced by adding or removing weights, of which the vertical positions are known, will be useful. Suppose Fig. 52 to represent a case where weights amounting in the aggregate to W tons have been put on board a ship, with their centre of gravity h feet above the water-line (W_1L_1) at which the ship floated before the weights were added. Let G be the original position of the centre of gravity of the vessel, and M the metacentre corresponding to the water-line W_1L_1 ; then, if D be her displacement to that line, her stability for any angle α within the limits to which the metacentric method applies will have been—

$$\text{Moment of statical stability} = D \times GM \sin \alpha.$$

The addition of the weights W will increase the immersion of the ship by a certain amount, which can be estimated by the method of "tons per inch" explained in Chapter I. It may be assumed, however, that commonly the weights added are comparatively so small that their addition will only immerse the vessel a few inches, and that within these limits the sides are practically vertical. The centre of gravity of those weights may be fixed relatively to the original water-line W_1L_1 .* Their moment about W_1L_1 will be = W

FIG. 52.

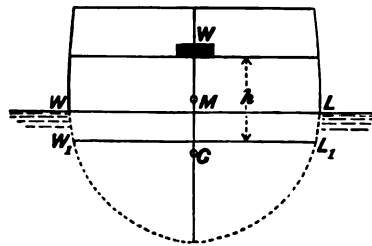

* For the full mathematical treatment of this subject, see the paper previously mentioned (p. 90, footnote)

on the "Geometry of Metacentric Diagrams."

$\times h$ foot-tons; and then the expression for the statical stability at the angle α will become altered by the addition of the weights to—

$$\text{I. Moment of statical stability} = (D \times GM - W \times h) \sin \alpha.$$

Had the weights W been placed with their centre of gravity at a distance h below W_1L_1 , the stability would have been *increased* by the amount $Wh \sin \alpha$, and—

$$\text{II. Moment of statical stability} = (D \times GM + W \times h) \sin \alpha.$$

Conversely, if weights are removed from *above* the water-line W_1L_1 (say, W tons at a height h feet), the stability of a ship is *increased* by the change, and for an angle α —

$$\text{III. Moment of statical stability} = (D \times GM + W \times h) \sin \alpha.$$

Whereas, if the same weights are removed from an equal distance *below* WL , the stability is *decreased*; and

$$\text{IV. Moment of statical stability} = (D \times GM - W \times h) \sin \alpha.$$

As an example, suppose a ship of 6000 tons' displacement, with a metacentric height (GM) of $3\frac{1}{4}$ feet, to have additional guns, weighing 50 tons, placed on her upper deck, their common centre of gravity being 18 feet above water. Rule I. applies, and we have, for an angle α —

$$\begin{aligned} \left. \begin{array}{l} \text{Original moment of statical} \\ \text{stability} \end{array} \right\} &= 6000 \text{ tons} \times 3\frac{1}{4} \text{ feet} \times \sin \alpha. \\ &= 19,500 \text{ (foot-tons)} \times \sin \alpha. \\ \left. \begin{array}{l} \text{Moment of statical stability} \\ \text{after the addition of the} \\ \text{weights} \end{array} \right\} &= (19,500 - 50 \times 18) \sin \alpha. \\ &= 18,600 \text{ (foot-tons)} \times \sin \alpha. \end{aligned}$$

Suppose the same ship to have 100 tons of water-ballast added, instead of the guns, the centre of gravity of the ballast being 16 feet below the water-line. Then Rule II. applies, and the stability is increased, becoming for angle α —

$$\begin{aligned} \left. \begin{array}{l} \text{Altered moment of statical} \\ \text{stability} \end{array} \right\} &= (19,500 + 100 \times 16) \sin \alpha. \\ &= 21,100 \text{ (foot-tons)} \times \sin \alpha. \end{aligned}$$

It is unnecessary to give illustrations of the remaining rules for the removal of weights.

When "metacentric diagrams," such as those given on p. 90, are available, the foregoing rules cease to be of much value; because the effect upon the vertical position of the centre of gravity of the addition or removal of any weights, however large, is easily estimated; the corresponding change in draught can be determined; and the new position of the metacentre corresponding to the altered draught

is indicated on the metacentric diagram. Where no metacentric diagrams are available, the approximate rules given above will be of service to a commanding officer.

Estimates for Changes of Trim.—Attention must next be turned to longitudinal inclinations, or changes of trim. The process by which the naval architect estimates *changes of trim* produced by moving weights already on board a ship is identical in principle with the inclining experiment described above; only in this case he makes use of a metacentre for longitudinal inclinations (or, as it is usually termed, the “longitudinal metacentre”), instead of the transverse metacentre with which we have hitherto been concerned. The definition of the metacentre already given for transverse inclinations is, in fact, quite as applicable to inclinations in any other direction, longitudinal or skew; but it has already been explained that, as the transverse stability of a ship is her minimum, while the longitudinal stability is her maximum, only these two need be considered.

The general expression for the height of the longitudinal metacentre above the centre of buoyancy resembles in form that given on p. 86, for the transverse metacentre; but for longitudinal inclinations the moment of inertia of the plane of flotation has to be taken about a transverse axis passing through the centre of gravity of that plane. Hence, using the same notation as before, we may write—

$$\left. \begin{array}{l} \text{Moment of inertia of plane of flotation (for} \\ \text{estimates of height of longitudinal meta-} \\ \text{centre)} \end{array} \right\} = K_1 \times B \times L^3$$

$$\left. \begin{array}{l} \text{Height of longitudinal meta-} \\ \text{centre above centre of} \\ \text{buoyancy} \end{array} \right\} = \frac{K_1 \times B \times L^3}{\text{volume of displacement}}$$

Following out a process of reduction similar to that described for the transverse metacentre, this last formula may be written—

$$\text{Height of longitudinal metacentre} = \frac{K_1 \times B \times L^3}{C \times L \times B \times D} = b \cdot \frac{L^2}{D}$$

The values of *K* and *C* vary considerably in different classes of ships; and so does the ratio *b*; but the following averages obtained for various types may be of some value, although no approximations can be trusted to replace exact calculations from ship-drawings:—

	Values of <i>b</i> .
Unarmoured war-ships and merchant ships of ordinary proportions07 to .08.
Armoured ships; merchant ships of special classes07 to .09.

The value .075 may be used as a rough approximation in most cases; but there are many exceptions to its use.

In ships of war the ratio of mean draught to length frequently lies between 1 to 12 and 1 to 14; the average of these ratios, 1 to 13, is as nearly as possible the average value of b stated above. Hence, in such vessels, the height of the longitudinal metacentre above the centre of buoyancy usually approximates to equality with the length, in some classes exceeding it by 20 to 25 per cent., and in others falling below it by 10 to 15 per cent. In sea-going merchant ships the ratio of mean draught to length is usually less than in war-ships; and the height of the longitudinal metacentre above the centre of buoyancy is sometimes 40 per cent. greater than the length. In vessels of extremely shallow draught, such as river steamers having small displacements, but large moments of inertia of the planes of flotation, the height of the longitudinal metacentre is exceptionally great in proportion to the length. As ships lighten, the heights of their longitudinal metacentres usually increase considerably, and for merchant ships where the variations in draught are considerable, it is often found useful to construct "metacentric diagrams," for the *loci* of longitudinal metacentres resembling in character those described for transverse metacentres on p. 89. For war-ships the changes from load to light draught are less considerable, and it is not customary to construct these longitudinal metacentric diagrams.

Damage to the skin of a ship, and the consequent admission of water to the interior, usually affects the longitudinal as well as the transverse stability; and the general remarks made on p. 115 may also be applied here. It is evident, moreover, that the greatest loss of longitudinal stability must result from the flooding of compartments near the bow and stern, unless the buoyancy of the water-line area at the tops of these compartments is preserved by watertight flats or platforms, as explained on p. 27. The moment of inertia, it will be remembered, consists of the sum of the products of each element of area of the plane of flotation by the *square* of its distance from the transverse axis passing through the centre of gravity of that plane; hence the most distant portions of the area contribute the largest part of the moment of inertia, and if their contributions are withdrawn that moment is considerably diminished. As an extreme example, the *Inflexible* may be again mentioned. When the unarmoured ends are intact, the longitudinal metacentre of that ship is 292 feet above the centre of buoyancy; but when the ends are "riddled," the corresponding height is reduced to rather less than 33 feet.

A comparison of the statements made respecting the heights of

the transverse and longitudinal metacentres, will show how much greater is the longitudinal than the transverse stability of ships. An example may enforce the contrast. The *Warrior* has a longitudinal metacentric height of about 475 feet against a transverse metacentric height of 4.7 feet. To incline her 10 degrees longitudinally would require a moment one hundred times as great as would produce an equal inclination transversely. Or, to state the contrast differently, the moment which would hold the ship to a steady heel of 10 degrees would only incline her longitudinally about $\frac{1}{10}$ degree, equivalent to a change of trim of 6 or 8 inches on a length of 380 feet.

In Figs. 53, 54, are given illustrations of the change of trim

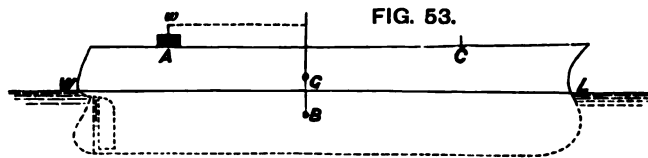

produced by moving weights already on board a ship; but, before proceeding further, it may be well to repeat the explanation given in an earlier chapter of the term "change of trim." The *difference of the draughts* of water forward and aft (which commonly takes the form of excess in the draught aft) is termed the trim of the ship. For instance, a ship drawing 23 feet forward and 26 feet aft is said to trim 3 feet by the stern. Suppose her trim to be altered, so that she draws 24 feet forward and 25 feet aft, the "change of trim" would be 2 feet, because she would then trim only one foot by the stern. In short, "change of trim" expresses the sum of the increase in draught at one end and decrease in draught at the other; so that, if the vessel be inclined longitudinally through an angle α , and L be her length—

$$\text{Change of trim} = L \times \tan \alpha.$$

Suppose the height of the longitudinal metacentre above the centre of gravity to be GM, as in Fig. 54, then, when the weight w is shifted longitudinally along the deck from A to C through a distance d , we shall have, by similar reasoning to that given in the case of the inclining experiment, the centre of gravity moving parallel to the deck, and—

$$\text{Shift of centre of gravity } (GG_1) = \frac{w \cdot d}{D}$$

also—

$$GG_1 = GM \tan \alpha = \frac{w \cdot d}{D}; \text{ whence } \tan \alpha = \frac{w \cdot d}{D \times GM}$$

and from the above expression—

$$\text{Change of trim} = L \times \tan \alpha = \frac{w \cdot d}{D} \times \frac{L}{GM}$$

Take the case of the *Warrior*, for which, at a draught of $25\frac{1}{2}$ feet, length = $L = 380$ feet; metacentric height = $GM = 475$ feet; dis-

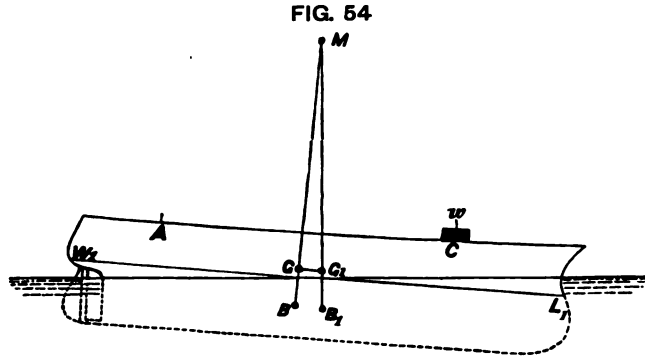

placement = 8625 tons. Suppose a weight (w) of 20 tons to be shifted longitudinally 100 feet—

$$\text{Change of trim} = \frac{20 \times 100}{8625} \times \frac{380}{475} = .186 \text{ foot} = 2\frac{1}{4} \text{ inches.}$$

It is usual to obtain for a ship the value of the “moment to change the trim one inch,” when floating at the load-draught; and then for changes of trim up to 2 or 3 feet no great error is involved in assuming that for a change of trim of any number of inches the moment required will equal that number of times the moment which will change the trim one inch. Substituting in the equation—

$$\text{Change of trim} = \frac{w \cdot d}{D} \times \frac{L}{GM}$$

one inch as change of trim (*i.e.* $\frac{1}{12}$ foot), we have—

$$\frac{1}{12} = \frac{w \cdot d}{D} \times \frac{L}{GM} : \text{whence } w \cdot d = \frac{D}{12} \times \frac{GM}{L}$$

Here wd = moment to change trim one inch. In war-ships of ordinary proportions, as explained on p. 120, the height, GM , approaches to equality with the length, L , and the following rule holds with a fair degree of approximation: “The moment to change the trim of a warship one inch—that is, the product of the weight “moved by the longitudinal distance it is shifted—will very nearly

“equal (in foot-tons) one-twelfth of the ship’s displacement (in tons).” In long fine vessels like the *Warrior*, this rule will give results rather below the truth, because GM is greater than L, whereas in short full ships its results will be rather in excess, because GM is less than L. In the *Warrior*, for example, where the metacentric height is proportionately great, $\frac{1}{12} \times D = 718$; whereas, the moment to change trim one inch is about 900 foot-tons. In the *Hotspur*, on the contrary, $\frac{1}{12} \times D = 334$; whereas the moment to change trim is 300 foot-tons, the metacentric height in this case being 211 feet, and the length 235 feet. In sea-going merchant ships the moment to change trim one inch would probably be 30 to 40 per cent. in excess of the approximate rule; and clearly that rule does not apply to shallow-draught vessels or special types.

The conditions are rather more complicated when weights are to be added to a ship, being placed with their centres of gravity in certain known positions, and it is required to determine the resultant draughts of water at the bow and stern. A good approximation may, however, be made as follows, supposing that the weights added are small when compared with the total weight of the ship—a supposition which will be fair in most cases. First, suppose the weights to be placed on board directly over the centre of gravity of the load-line section of the ship; then the vessel will sink bodily without change of trim, until she reaches a draught giving an addition to the displacement equal to the weights added. This can be estimated by the method of tons per inch immersion previously explained. The centre of gravity of the load-line section, or plane of flotation, usually lies a few feet abaft the middle of the length of the ship at the water-line, say, from one-thirtieth to one-fiftieth of the length abaft the middle. Having supposed the weights concentrated over this point, the next step is to distribute them, moving each to its desired position; each weight is multiplied by the distance it would have to be moved either forward or aft, and the respective sums of the products forward and aft being obtained, their difference is ascertained, this difference constituting the “moment to change trim.” The final step is to estimate the resultant change of trim due to this moment by the metacentric method previously explained. For example, take the *Warrior*, and suppose the weights in the table on p. 124 to be placed on board.

Moment to change trim one inch (say) = 890 foot-tons ;

$$\therefore \text{Change of trim} = \frac{1780}{890} = 2 \text{ inches ;}$$

$$\left. \begin{array}{l} \text{Increase in mean} \\ \text{draught . . .} \end{array} \right\} = \frac{\text{weights added}}{\text{tons per inch}} = \frac{250}{41} = 6 \text{ inches.}$$

Weight.	Distance from centre of gravity of plane of flotation.	Products.	
tons.	feet.	Before.	Aft.
10	140	1400	—
30	120	3600	—
20	40	800	—
40	5	200	—
60	8	—	480
50	60	—	3000
25	100	—	2500
15	120	—	1800
250	—	6000	7780 6000
Moment to change trim (by the stern) ...		1780	

If the original draught of water was 25 feet forward and 26 feet aft, mean $25\frac{1}{2}$ feet, the altered mean draught will be 26 feet, and the corresponding draft forward will be about 25 feet 5 inches, and aft 26 feet 7 inches.*

Stability of Ships partially Water-borne.—A vessel partially water-borne and partly aground loses stability as compared with her condition when afloat. One of the commonest illustrations of this fact is found in the case of boats run bow-on to a shelving beach; and instances are on record where vessels in dock have fallen over on their sides in consequence of a similar loss of stability,† when just taking or leaving the blocks, and not supported by side-shores, while the water was being admitted to or pumped out of the docks. For our present purpose it will suffice to indicate in general terms the conditions influencing the loss of stability. When afloat, the ship is wholly supported by the buoyancy due to the water she displaces; when her keel touches the blocks or ground, she is partly supported by the upward pressure at that point, the remainder of her weight being supported by the water then displaced, which is by supposition less than the total displacement due to her weight. Having given the height to which the water rises on the ship at

* To be exact, the alterations in draught forward and aft should be proportioned to the distances of the centre of gravity of the water-line plane from bow and stern.

† A well-known case is that of her Majesty's troopship *Perseverance*, which

fell over on her side when being undocked at Woolwich some years ago. The matter was fully investigated at the time by Mr Barnes, and he has since contributed an article on the same subject to No. 4 of the *Annual of the Royal School of Naval Architecture*.

any instant, it is easy to estimate the corresponding buoyancy; then the difference between it and the weight of the ship measures the pressure at the point of contact, and corresponds to the buoyancy contributed by the volume of the ship lying between her load-line when afloat and the actual water-line at the time she is partly water-borne. What has really been done, therefore, is to transfer the buoyancy of this zone (acting through the centre of gravity of the zone) down to the point of contact of the keel with the ground. And when the vessel is inclined through a small angle from the upright, this pressure actually tends to upset her, whereas the buoyancy it has replaced would usually tend to right her. Hence the decreased stability.

It is possible to obtain a ready rule for estimating the loss.

Suppose—

P = pressure of end of keel on ground;

h = height of centre of gravity of the aforesaid zone above the point of contact of the keel and ground;

W = total weight of ship.

Then a simple mathematical investigation shows that—

$$\left. \begin{array}{l} \text{Loss of metacentric height (GM) due to partial} \\ \text{grounding (approximately)} \end{array} \right\} = \frac{Ph}{W}$$

Take as an example the case of the *Perseverance*, for which—

$$P = 51 \text{ tons}; W = 1303 \text{ tons}; h = 13 \text{ feet,}$$

$$\therefore \text{Loss of metacentric height} = \frac{51 \times 13}{1303} = 6 \text{ inches (about).}$$

Vessels having a very considerable normal trim by the stern are most liable to this kind of accident, and the upsetting tendency due to the pressure reaches its maximum when the vessel is about to take the ground along the whole length of the keel. The practical method of guarding against such accidents of course consists in carefully shoring, using mast-head tackles, or otherwise supporting the vessel externally, in order to prevent her from upsetting.

Transverse Stability at Large Angles of Inclination.—Up to this point attention has been directed exclusively to the stability of ships inclined to angles lying within the limits to which the metacentric method applies. For longitudinal inclinations, except in very special cases, nothing further is required; but for transverse inclinations it is necessary to ascertain the statical stability at greater angles, and to determine the inclination at which the ship becomes unstable. The general principles previously laid down for determining the moment of the couple formed by the weight and buoyancy apply to all angles of inclination; and it is consequently

only necessary to fix for any angle the vertical line, passing through the centre of buoyancy, along which the resultant upward pressure of the water acts. This is done by calculation from the drawings of a ship, and involves considerable labour; but the principle upon which it is based may be simply explained. Fig. 55 shows the

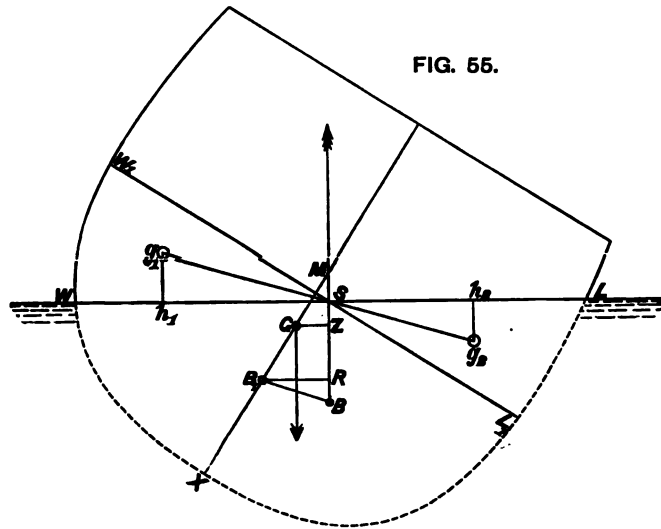

cross-section of a ship which, when upright, floated at the water-line W_1L_1 , having the volume of displacement indicated by W_1XL_1 , and the centre of buoyancy B_1 . When inclined as in the diagram, WL is the water-line, WXL the volume of displacement, and B the corresponding centre of buoyancy. Since the displacement remains constant, the volumes WXL and W_1XL_1 are equal, and they have the common part WSL_1XW . Deducting this common part, the remainder (W_1SW) of the volume W_1XL_1 must equal the remainder (LSL_1) of the volume WXL ; or, as it is usually stated, the *wedge of immersion* LSL_1 must equal the *wedge of emersion* W_1SW . In other words, the inclination of the vessel has produced a change in the form of the displacement equivalent to a transfer of the wedge WSW_1 to the equal, but differently shaped, wedge LSL_1 . This is obviously a parallel case to that of the lever explained on p. 106. In Fig. 55, let g_1 be the centre of gravity of the wedge of emersion, g_2 that of the wedge of immersion, and v the volume of either wedge; then what has been done is equivalent to a transfer of this volume v to the immersed side, into the position having g_2 for its centre of gravity. The moment due to this shift $= v \times g_1g_2$; and its consequence is a motion of the centre of gravity of the total

volume of displacement V from the original position, B_1 , to the new one, B , the line B_1B being parallel to g_1g_2 , and the length—

$$BB_1 = \frac{v}{V} \times g_1g_2$$

It thus becomes obvious that, when the positions of the centres of gravity of the wedges (g_1 and g_2) for any inclination are known, the new position of the centre of buoyancy (B) can be determined with reference to its known position (B_1) when the ship is upright. And this is virtually the process adopted in the calculation.* If B_1R be drawn perpendicular to BM , Fig. 55, and g_1h_1, g_2h_2 perpen-

FIG. 56.

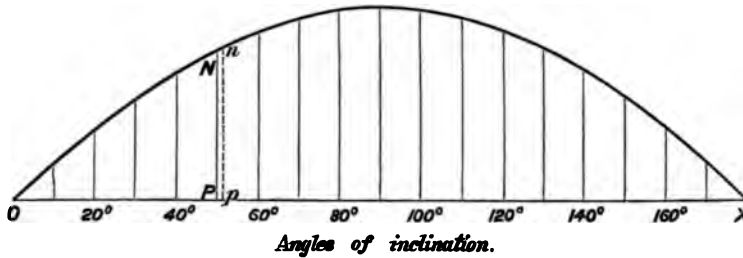

dicular to WL , then, by the same principle as is used above, the length $B_1R = \frac{v}{V} \times h_1 h_2$.

Also, if the angle of inclination WSW_1 be called α —

$$GZ = B_1R - B_1G \sin \alpha,$$

and consequently—

$$\begin{aligned} \text{Moment of statical stability} &= V \times GZ = V(B_1R - B_1G \sin \alpha) \\ &= v \times h_1 h_2 - V \times B_1G \sin \alpha. \end{aligned}$$

This expression for the righting moment (in terms of the volume of displacement) is known as “Atwood’s formula,” and is commonly employed in constructing “curves of stability.”

Fig. 56 shows the method of construction for such a curve. On the base-line OPX degrees of inclination are set off on a certain scale, O corresponding to the upright; the ordinate of the curve drawn perpendicular to the base-line at any point measures, on a certain scale, the “arm of the righting couple” (GZ) for the corresponding angle of inclination. Thus, OP represents an inclination

* For details of methods of calculation, see a paper contributed by the late Mr. W. John and the author to the *Transactions of the Institution of Naval*

Architects for 1871, and by other writers in the same *Transactions* for 1882, 1884, etc.

of 50 degrees, and the corresponding ordinate PN represents the length of the arm of the couple formed by the weight and buoyancy at that inclination. By calculation, successive values of GZ are found for inclinations differing by an interval of 8 or 10 degrees; and the curve is drawn through the tops of the ordinates thus found. Measurement of the ordinates renders any calculation unnecessary for inclinations other than those made use of in drawing the curve. It will be observed that, starting from the upright position, the stability gradually increases, reaches a maximum value, and then decreases, finally reaching a zero value (where the curve crosses the base-line) at the inclination where the ship becomes unstable. The preceding explanation of the causes governing the position of the centre of buoyancy will furnish the reason for this gradual increase and subsequent decrease in the stability. The length (OX), measuring the inclination at which the ship becomes unstable, determines what is known as the *range* of stability for the ship, and this is an important element of safety.

One of the simplest illustrations of a curve of stability is that for the cigar-shaped ship shown in section by Figs. 41, 42, p. 94. In such vessels, as previously explained, for any angle α $GZ = GM \sin \alpha$, and the curve of stability is constructed by simply setting up, at any point on the base-line, a length representing the sine of the angle of inclination corresponding to that point. Fig. 56 shows this curve. The range is 180 degrees; the maximum stability is reached at 90 degrees, and the curve is symmetrical about its middle ordinate. Variations in the values of the metacentric height (GM) affect all the ordinates of the curve in the same proportion.

Ship-shaped forms are less easy to deal with; but a brief explanation of the causes chiefly influencing the form and range of curves of stability in ships will be of value. These causes may be grouped under the following heads: (1) Freeboard; (2) beam; (3) the vertical position of the centre of gravity; (4) the vertical position of the centre of buoyancy when the ship floats, upright. Both freeboard and beam are of course relative measures, and should be compared with the draught of water. With freeboard, moreover, must be associated the idea of "reserve of buoyancy" (see p. 8). The vertical position of the centre of gravity must be compared with the *total depth* of the ship (excluding projecting keel), and so must that of the centre of buoyancy. It is also necessary to note the relation between the mean draught and the depth of the centre of buoyancy below the water-line, as that relation indicates roughly the fulness or fineness of form in the under-water portion of the ship. Before giving any illustrations of curves of stability for actual ships, a few simple examples may be taken from box-shaped

vessels in order to show the relative influence of the above-mentioned features. The following cross-sections will serve the purpose:—

Dimensions.	No. 1.	No. 2.	No. 3.
Beam	feet. 50½	feet. 50½	feet. 57½
Draught	21	21	21
Freeboard	6½	13½	6½
Metacentric height (GM)	2·6	2·6	5

Taking No. 1 as a standard for comparison, its curve of stability is shown by A in Fig. 57. The effect of adding 7 feet to the freeboard—supposing the centre of gravity to be unchanged in position—is seen by comparing the curve of stability B for No. 2 with the curve A.

FIG. 57.

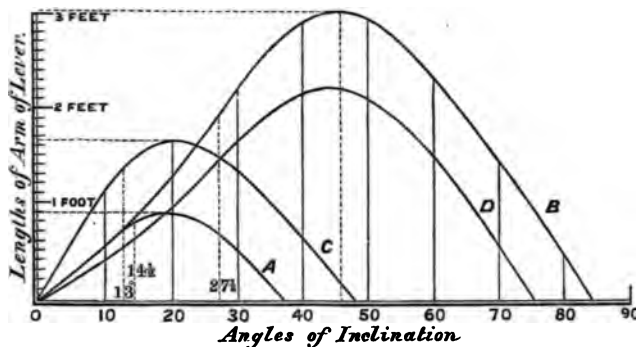

Similarly, the effect of adding 7 feet to the beam is seen by comparing the curve of stability C for No. 3 with the other two curves. Only a few further words of explanation will be necessary.

At an inclination of 14½ degrees, the “deck-edge,” or angle, of No. 1 will be immersed; for No. 2 the corresponding inclination is nearly doubly as great, viz. 27½ degrees. Fig. 58 shows No. 2 with its deck-edge “awash.” Fig. 59 shows No. 1 at the same inclination, with a considerable portion of its deck immersed. Up to the inclination, when the deck-edge of either vessel is just immersed, the centre of buoyancy B moves steadily outward in relation to the centre of gravity as the inclination increases, in consequence of the gradual increase in the volume of the wedges of immersion and emersion, and in the distance g_1g_2 between their centres of gravity. But after the deck goes under water, this outward motion of the centre of buoyancy relatively to the centre of

gravity becomes slower, or is replaced by a motion of return, in consequence of the decrease in the distance g_1g_2 between the centres

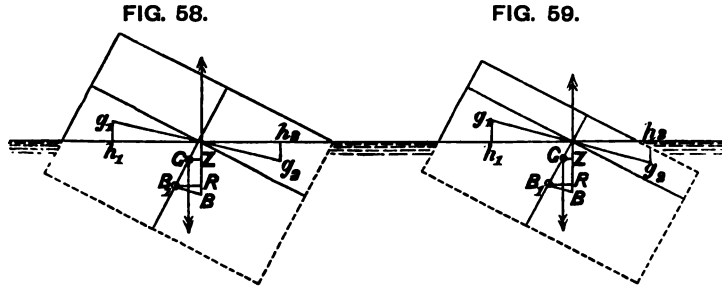

of gravity and the less rapid growth of the volumes of the wedges. The increase in value of the term $B_1G \sin \alpha$ in the formula—

$$V \times GZ = v \times h_1 h_2 - V \cdot B_1G \sin \alpha,$$

also tends to diminish GZ as the inclination increases. The greater the angle of inclination corresponding to the immersion of the deck-edge—in other words, the higher the ratio of freeboard to breadth—the greater in ordinary cases will be the inclination at which the statical stability reaches its maximum value. Up to $14\frac{1}{2}$ degrees, the curves A and B in Fig. 44 are identical; but then B continues to rise rapidly, not reaching its maximum until 45 degrees, whereas A reaches its maximum at 20 degrees. The low-freeboard box, moreover, has a range of less than 40 degrees, whereas the high-freeboard box (No. 2) has a range of 84 degrees.

Turning to No. 3 section, and the curve of stability C, it will be noticed that the increase of 7 feet in beam causes a considerable increase in the metacentric height (GM). For moderate inclinations, $GZ = GM \sin \alpha$, and therefore this increase in GM is accompanied by a corresponding increase in the steepness of the earlier part of the curve of stability C, as compared with the curves A and B in Fig. 57. The deck-edge becomes immersed, however, at 13 degrees, the maximum stability is reached at 20 degrees, and the range of stability is less than 50 degrees as against 84 degrees in curve B for the higher freeboard vessel. The comparison of these curves will show how much more influential increase of freeboard is than increase of beam in adding to the amount and range of the statical stability of ships.

Lastly, to illustrate the effect of the vertical position of the centre of gravity upon the forms of curves of stability, let it be assumed that the high-freeboard vessel (No. 2 section) has its centre of gravity raised one foot, leaving the value of the metacentric height (GM) 1.6 foot. This will be no unfair assumption, seeing

that the increase in freeboard, and consequently in total depth, would in practice be associated with a rise in the centre of gravity. The curve of stability D, Fig. 57, corresponds to this last case. For each inclination the decrease in the arm of the righting couple, as compared with curve B, is given by the expression—

$$\text{Decrease in } GZ = GG_1 \times \sin \alpha,$$

where GG_1 (rise in position of centre of gravity) is one foot. Initially the curve D falls within A and B, the vessel being more crank. It has, however, its maximum ordinate at 45 degrees, and a range of 75 degrees, comparing very favourably indeed with the curve C for the low-freeboard vessel with broad beam (No. 3).

Turning from these simple prismatic forms to actual ships, it will be interesting to notice how the curves of stability for different classes of ships illustrate the varying influence of beam, freeboard, vertical position of the centre of gravity, etc. The earliest curves of stability on record were constructed at the Admiralty in 1867, prior to which date there appears to have been no exact determination of the stability of ships at large angles of inclination when their upper decks were partially under water, or of their ranges of stability. So long as ships of high freeboard were employed exclusively this limitation of inquiry as to variation in statical stability was natural enough; but when low-freeboard vessels came into use the necessity arose for more extended calculations, in order to determine the angles of inclination at which the vessels became unstable. Since 1870 the practice of constructing curves of stability for each class of vessel in the Royal Navy has been established; and has been followed in foreign navies. More recently similar curves have been constructed for yachts and for various classes of merchant ships. A large amount of valuable data has thus been accumulated already, and important additions are continually being made thereto.

The first set of illustrations of curves of stability, contained in Fig. 60, is limited to representative types of war-steamers, and to their fully laden condition. In all cases the centres of gravity have been ascertained by experiment, and the distribution of the weights is accurately known. Those weights are supposed to be secured in such a manner that no shift takes place even at the most extreme inclinations. This may be considered an improper supposition, especially in cases where stability is maintained beyond the inclination of 90 degrees from the upright; but it is to be observed that such extreme inclinations are not likely to be reached, whereas for less inclinations the supposition affects all classes similarly. Further, it is assumed in making the calculations that throughout the inclina-

tions no water enters the interior through ports, scuttles, hawse-pipes, and other openings in the sides; or through hatchways, ladder-ways, and other openings in the decks. This assumption is fair enough as

FIG. 60.

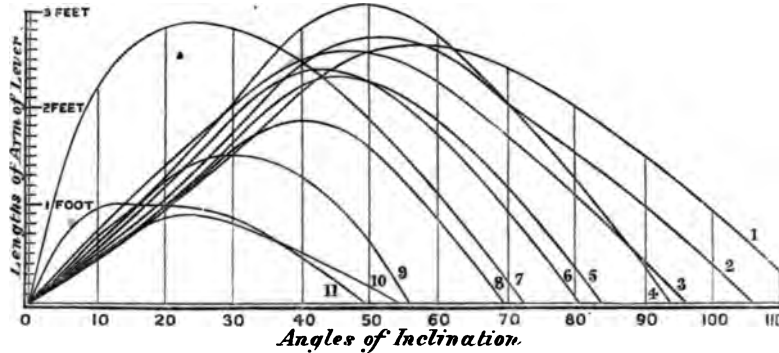

- | | | |
|-----------------------|------------------------|------------------------|
| 1. <i>Juno.</i> | 5. <i>Invincible.</i> | 9. <i>Devastation.</i> |
| 2. <i>Inconstant.</i> | 6. <i>Achilles.</i> | 10. <i>Captain.</i> |
| 3. <i>Endymion.</i> | 7. <i>Miantonomoh.</i> | 11. <i>Glatton.</i> |
| 4. <i>Serapis.</i> | 8. <i>Monarch.</i> | |

regards most of the openings, which are furnished with watertight covers, plugs, etc., and as regards some of the hatchways which are usually kept open even in a seaway, it is only necessary to remark that they might be battened down on an emergency, while their situation near the middle line of the deck prevents the water from reaching them except at very large angles of inclination. It is not usual to include erections above the upper decks of war-ships in making calculations for curves of stability unless they are thoroughly closed in and made watertight. For example, deck-houses, open-ended forecastles and poops, etc., are not included; but closed batteries, breastworks, forecastles, and poops are reckoned in the contributories to stability. Partially watertight erections no doubt aid ships in recovering from extreme lurches, etc., which put them under water only for very short periods, so that their omission from the calculation is on the side of safety. The following table gives the principal dimensions, etc., of these representative war-steamships:—

Name.	Class of ship.	Length.	Breadth extreme.	Mean draught.	Height of upper deck amidships above water.	Displacement.
	<i>Unarmoured.</i>	ft.	ft. in.	ft. in.	ft. in.	tons.
<i>Endymion</i> .	Old type steam frigate .	240	47 10	20 6	14 8	3300
<i>Juno</i> .	Covered-deck corvette .	200	40 0	17 4	14 6	2215
<i>Inconstant</i> .	Swift cruising frigate .	337	50 3½	23 10½	15 3½	5782
<i>Serapis</i> .	Indian troopship .	360	49 0	19 5	15 0	5976
	<i>Armoured.</i>					
<i>Glatton</i> .	Breastwork monitor .	245	54 0	18 9	3 0	4912
<i>Miantonomoh</i>	American monitor .	250	52 10	14 0	3 0	3842
<i>Captain</i> (late)	Low-freeboard } turret-	320	53 3	25 0½	6 6	7790
<i>Monarch</i> .	High-freeboard } ships.	330	57 6	24 1½	14 0	8215
<i>Devastation</i> .	Mastless } turret-	285	62 3	26 1½	11 3*	9061
<i>Achilles</i> .	Early type } broadside	380	58 3½	26 5	15 0	9484
<i>Invincible</i> .	Later type } ships.	230	54 0	22 6	16 0	6060

* Only 4½ feet aft.

In Fig. 60 the respective curves of stability for these vessels appear with reference numbers, enabling them to be distinguished; and they will repay a careful study, as illustrations of the comparative stabilities of high- and low-sided vessels, armoured and unarmoured. It will be remarked that the ordinates of the curves have to be multiplied by the respective displacements of the ships in order to obtain the righting moments.

As ships of war lighten by the consumption of coals, provisions, stores, etc., their curves of stability frequently lose in area and range. This is due to the fact that the rise in the vertical position of the centre of gravity as the ships lighten produces a greater effect in reducing the stability than the increase in freeboard produces in the contrary sense. Any such decrease in stability can be prevented in ships fitted to carry water-ballast, as all armoured ships are; but as a rule there is no necessity to use water-ballast even in the extreme light condition. There are, moreover, exceptions to the rule just stated; some types having little, if any, less stability in the light condition than they have when fully laden. In many modern cruisers and battle-ships a considerable portion of the coal is stowed above the protective decks; consequently in the light condition the centre of gravity is not much higher than in the load condition, and this rise is counterbalanced by the increase in freeboard. As an example, reference may be made to the two curves for the *Inflexible* in Fig. 61. The curve 1 shows the ship fully laden, and the curve 2 indicates her condition when 1500 tons of coals and consumable stores have been removed. This diagram also illustrates the influence which damage to the skin of a ship and the consequent entry of water into

the hold may have upon the form and range of her curve of stability. The curves 3 and 4 show the conditions of statical stability of the *Inflexible* when the unarmoured ends are completely riddled. This

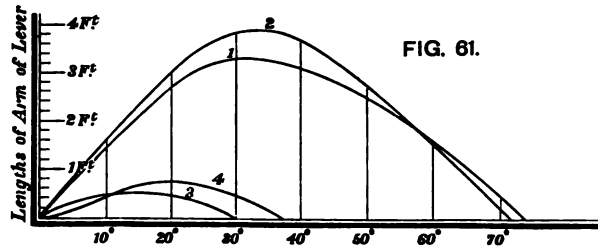

- 1. Load condition, ends intact.
- 2. Light " " "
- 3. Load " " ends riddled.
- 4. Light " " "

extensive damage would cause the ship to sink more than 2 feet below her ordinary load-line, reducing her freeboard by an equal amount, and lessening her stability very greatly. The tabular statement appended will supplement the information given in the diagram.*

Condition of <i>Inflexible</i> . (see Fig. 61).	Draught.		Displacement.	Deck enters water.	Angle of maximum stability.	Maximum value of GZ.	Range of stability.	Metacentric height (GM).
	ft.	in.						
1. Fully laden, ends intact	24	7	11,500	14°	31.2°	3.28	74.3°	8.25
2. Light condition, ends intact	21	10	10,000	18°	31.7°	3.98	71.5°	8.5
3. Fully laden, ends riddled	26	8½	11,500	11°	13.5°	.57	30.0°	2.0
4. Light condition, ends riddled	23	9	10,000	15°	20.8°	.79	36.8°	2.22

This is an extreme illustration of the loss of stability due to damage to the skin of a ship; but similar considerations hold good in all ships, and the extent to which their stability may be decreased by collision or other accident can be readily estimated when the extent of the damage is known. Without any actual damage to the skin of a ship water may find its way into the interior through open ports or scuttles in the sides, or open hatchways in the decks, the

* For a full discussion of the stability of this ship see the Report of the Committee of 1878 (*Parliamentary Paper*).

result being a more or less serious decrease in stability. Such occurrences are clearly exceptional, but they have happened in ships caught by squalls of wind in comparatively smooth water. The *Eurydice* is an example. Fig. 63, p. 138, shows two curves of stability for that ill-fated vessel. The first, marked 3, is the curve for her fully laden condition with all ports closed, and openings in sides and decks made watertight; the second, marked 4, is the curve corresponding to her condition when she was capsized, the ports having been open, and the water having entered through them. In curve 3, the freeboard (to the upper deck) was between 11 and 12 feet; whereas in curve 4 the freeboard was virtually reduced to 4 feet. Having regard to the explanations given on p. 130, as to the influence of freeboard on range of stability, the reduction of range and area of the curve of stability from 3 to 4 in Fig. 63 will be readily understood.

Turning from war-ships to merchant ships, it is not possible to give similarly full and exact information respecting their curves of stability. The principal reasons for this difference have been stated on p. 85. In Fig. 62 there are given, however, the curves for a

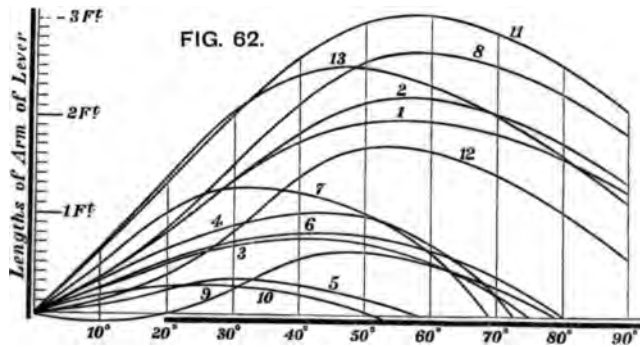

Curves of stability for merchant steamers.

Note.—The dimensions, etc., of these vessels appear in the table on p. 136, under the respective reference numbers marked on the curves.

considerable number of representative merchant steamships, laden to certain assumed load-lines, which are approximately those at which the ships would be worked. The nature of the stowage assumed in each case is explained in the tabular statement on p. 136, and the principal dimensions, etc., of the vessels are also recorded therein.*

* For a few of these examples of curves of stability the author is indebted to Mr. Martell's Paper on "Causes of Unseaworthiness" (*Transactions* of the

Institution of Naval Architects for 1880). The remainder have been obtained by direct calculation for ships bought into the Royal Navy, and by calculations

PARTICULARS OF THE VESSELS WHOSE CURVES OF STABILITY ARE GIVEN IN FIG. 62.

Reference to curve.	Class of ship.	Length.		Extreme breadth.	Mean draught		Metacentric height.	Height of upper deck amidships above water.		Displacement.	
		ft.	in.	ft.	in.	ft.	in.	feet.	ft.		in.
1	Long, swift steamer, miscellaneous cargo	390	0	39	0	23	0	2·0	8	6	6400
2											
3	Steamer of moderate speed, homogeneous cargo	264	0	32	0	18	9½	1·1	5	2	3220
4											
5	Steamer, large carrying power, homogeneous cargo	320	0	40	0	23	6	0·4	6	1½	6380
6											
7	Same vessel, light condition	"	"	"	"	9	7	3·0	21	0½	2110
8											
9	Same vessel, assumed initially unstable	"	"	"	"	"	"	0·5	"	"	"
10											
11	Steamer, cargo of iron	285	0	35	4	18	0	3·5	6	6	3800
12											
13	Despatch vessel (<i>Iris</i>)	300	0	46	0	19	9	3·7	8	7½	3735

It is interesting to compare the curves of stability for the same vessels in the extreme load and light conditions, or to contrast the curves for a vessel carrying the same total weight differently distributed. Curve 9, Fig. 62, illustrates a hypothetical case, where a fully laden ship is unstable when upright, and yet has a considerable range of stability. Such conditions would not be accepted, in practice, for a ship proceeding to sea, but they are interesting as illustrations of the principles above laid down. When the vessel is upright, the metacentre is 5 feet *below* the centre of gravity. Initially the curve of stability falls below the base-line, and this is a graphic representation of instability. At an inclination of 20 degrees the curve crosses the load-line, and thence onward, the vessel has a positive righting moment until, at 80 degrees, she once more becomes unstable. The position (20 degrees) at which the curve crosses the base-line, is one of stable equilibrium; the upright position and that where she is inclined 80 degrees correspond to unstable equilibrium. It is a general law under the conditions assumed in calculating curves of stability that positions of stable and unstable equilibrium occur

made by the author's pupils at the Royal Naval College. For fuller details of certain of the last-mentioned calcu-

lations see a paper by the author in *Transactions* of the Institution of Naval Architects for 1881.

alternately. The position of 20 degrees is that to which the vessel would "loll" over from the upright in still water; and if moved slightly from this position, either to greater or less angles of heel, she would return to it as her position of rest. Similar conditions may occur in merchant ships when floating at light draught, without cargo on board; and they have been noted in special classes of war-ships when light.

It will be observed, on comparing Figs. 60 and 62, that many of the fully laden merchant ships have much greater ranges of stability than the armoured war-ships. This is largely due to the very different vertical distribution of the weights. In merchant ships great relative weights of cargo or equipment are usually carried low down in the holds, and the common centres of gravity of ships and cargoes lie low in proportion to the total depth. In war-ships, although the weights of machinery, coals, and ammunition are carried low down in the holds, heavy loads of armour, armament, etc., have to be carried high up on the sides or decks. As a consequence the centre of gravity usually lies higher (in proportion to the total depth) in war-ships, and especially in armoured ships, than it does in merchant ships, and this tends to diminish the range of stability. Further, the deep lading of merchant ships brings the centre of buoyancy for the upright position higher in the ships than is usual in war-ships; and this diminishes the distance between the centre of buoyancy for the upright position and centre of gravity, consequently tending to lengthen the range of stability. In yachts these two features are still further exaggerated, the distance between the centres of gravity and centres of buoyancy being very small, while the centres of gravity are drawn low down by the heavy weights of ballast fitted on the keels and floors.

To the foregoing illustrations of curves of stability for steam-ships may be added a few for sailing ships of various classes. Fig. 63 contains these additional curves, and in the accompanying tabular statement the principal dimensions, etc., of the vessels appear. They include a few examples of the now obsolete sailing ships of the Royal Navy, others of existing sailing ships of the mercantile marine, and others of typical yachts.* In nearly all cases the fully laden condition is taken. For the yachts and war-

* For the facts as to sailing yachts the author is indebted to the valuable researches of Mr. Dixon Kemp; for those relating to the *Sunbeam* he has to thank Lord Brassey; most of those as to merchant sailing ships are taken from the Report of the *Atalanta* Committee,

to whom they were presented by the late Mr. W. John. The curves 6 and 7 were calculated by the author's pupils at the Royal Naval College for the ship built by Messrs. A. and J. Inglis, of which the metacentric diagram appears in Fig. 39.

ships the stowage is accurately known, so that the curves strictly correspond to the actual condition of the vessels in their seagoing trim. For the merchant ships a stowage has necessarily been

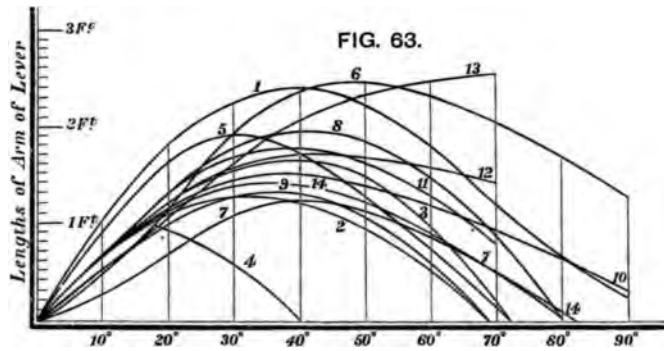

Curves of Stability for Sailing Vessels.

Note.—The dimensions, etc., of these vessels appear in the following table, under the respective reference numbers marked on the curves.

PARTICULARS OF THE VESSELS WHOSE CURVES OF STABILITY ARE GIVEN IN FIG. 63.

Reference to curve	Class of ship.	Length.		Extreme breadth.		Mean draught.		Metacentric height.		Height of upper deck amidships above water.		Displacement.
		ft.	in.	ft.	in.	ft.	in.	feet.	ft.	in.	tons.	
1	Sailing frigate, load condition .	131	0	40	7	17	4	6·2	10	9	1055	
2	Sailing frigate, light condition .	"	"	"	"	16	0	4·1	12	1	887	
3	{ Sailing frigate, load condition, } { ports shut .	141	0	38	8	16	7	4·5	10	6	1075	
4	{ Sailing frigate, load condition, } { ports open .											
5	Sailing brig, load condition .	100	6	32	4	14	0½	5·9	4	3½	483	
6	Sailing merchantman .	222	0	35	4	16	9	3·0	5	3	2030	
7	{ Sailing merchantman, homoge- } { neous cargo, and no ballast . }	"	"	"	"	"	"	1·3	"	"	"	
8	Sailing merchantman .	273	0	43	1	19	10	3·5	5	8	3980	
9	Sailing merchantman .	"	"	"	"	"	"	2·5	"	"	"	
10	Small sailing merchantman .	148	0	26	9	"	"	3·5	"	"	787	
11	Yacht	81	3	20	6	9	5	4·0	2	11	128	
12	Yacht	85	9	19	3	10	1	3·7	3	1	150	
13	Yacht	100	0	16	7	9	4	3·3	3	10	158	
14	{ Yacht (with auxiliary steam } { power) Sunbeam }	154	9	27	1	13	0	3·45	4	4	576	

assumed which is thought to be fairly representative of the ordinary condition. It is probable, however, that in some cases these merchant ships are stowed so that they have greater stability than is indicated on the diagram, and in other cases less stability. To illustrate these possible variations, the curves 6 and 7, or 8 and 9 may be taken. In

curve 6 the centre of gravity is supposed to be 1·7 feet lower than in curve 7; and in the second example the centre of gravity for curve 8 is 1 foot lower than for curve 9. The draught of water is the same in curves 6 and 7, or in curves 8 and 9; and the differences in stability arise entirely from variations in the vertical position of the centre of gravity.

Torpedo-boats are now extensively employed in all navies, and the larger classes have to serve at sea in rough water when required. Curves of stability for various classes are shown in Fig. 64, and are

FIG. 64.

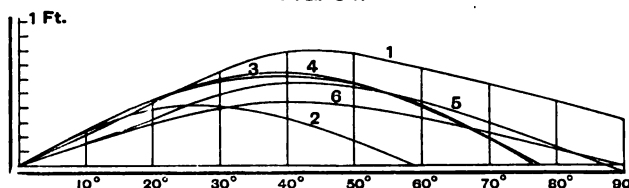

of considerable interest. The metacentric heights and dimensions are given in the table below. Large experience has been gained at sea with the English first-class boats, which have given the greatest satisfaction and proved themselves to be safe and seaworthy when properly handled. It will be seen that the angles of maximum stability on curves 4 and 5 occur at or about 40 degrees

Number of curve.	Description of boat.	Length.	Displacement.	Meta-centric height (G.M.).	Range of stability.
1	First class—Danish	feet. 137	tons. 110	feet. 1·38	degrees. over 90
2	French (as first built)	115	53	1·46	59
3	„ (as altered)	115	53	1·46	77
4	English	130	93	1·47	77
5	English	125	89	·82	86
6	Second class—English	63	14	·66	89

of inclination, and the range of stability is from 80 to 90 degrees. The Danish boat has even greater stability, and is of larger size. For the French boats, curve 2 shows conditions of stability which experience proved to be most unsatisfactory. These boats had considerable “tumble-home” of the sides above water, and comparatively large erections at the fore end for the torpedo apparatus. Some of them capsized in rough water, and the remainder were altered considerably in order to improve their stability. Curve 3 shows the

result of the changes made, and will be seen to compare well with the curves for the English boats. Curve 6 is for a second-class boat—the type built to be lifted on board and carried by large ships. Although the metacentric height is moderate, the character and range of the curve is very satisfactory, and many of these boats have satisfactorily stood the test of service in rough weather, although not built primarily for sea-work.

In connection with the alterations effected in the French torpedo-boats, some interesting investigations were made by M. Ferrand of the variations which might be caused in the curves of stability by changes of trim in smooth water, or by the changes in level of the water surrounding a boat steaming end on to the waves.* The curve 2 in Fig 64 corresponds to the normal trim. When the boat was immersed more deeply at the bow and correspondingly lightened aft in still water, the mean draught remaining as before, the metacentric height was diminished, and the area and range of the curve of stability were reduced. This resulted from the greater fineness of the fore body as compared with the after body. On the contrary, when the boats were trimmed more by the stern than in their normal condition, the metacentric height remained almost unaltered, while the range and area of the curve of stability were increased. Passing to wave-water, M. Ferrand showed, by calculations which were confessedly approximate and useful chiefly in making comparisons, that the instantaneous conditions of stability of the boats must be sensibly affected by the substitution of wave profiles for still water, and by the position of the wave crest in relation to the centre of the length of the boats. Obviously, if the after-part were almost emerged for a moment, and the fore part deeply buried in a wave-crest as the boat pitched, there would be a very serious decrease in stability. When the contrary condition occurred, the instantaneous conditions of stability would be much more favourable, although inferior to those for still water. Various intermediate positions of the wave-crest and different dimensions of hypothetical waves were made the basis of calculation, with the general result that the unusually fine fore body as compared with the after body, and the great fall home of the top-sides, involved unusual variations in stability under the conditions assumed as compared with torpedo-boats of ordinary form.

No doubt the points to which M. Ferrand drew attention exercise influence on the statical stability in all cases, so far as change of trim in still water, or the passage of waves along the sides of ships or boats is concerned. As a rule, however, it has not been found

* See vol. 2 (1892) of the *Bulletin de l'Association Technique Maritime*.

necessary to calculate curves of stability for these conditions. About the year 1871, when the loss of the *Captain* caused special attention to be given to questions of stability for war-ships, and especially for those of moderate freeboard, the author and the late Mr. John made a number of calculations for different types, assuming them to be trimmed excessively by the bow or stern. The results were very interesting, but showed that under the extreme assumptions made, with the low ends deeply immersed, but the sides and decks assumed to be intact and capable of excluding water, the ships in question retained a large amount of transverse stability.

In cases where the sides or decks are broken through near the extremities by collision or other causes, and considerable spaces in the interior are thrown open to the sea, large changes of trim must be produced, and the loss of buoyancy will be accompanied by serious decreases in the moments of inertia of the planes of flotation for both longitudinal and transverse inclinations. Under any assumed conditions of damage and subdivision for a particular ship, the calculations necessary to determine her position when brought to rest, or whether she will founder, can easily be made. Apart from such calculations, it may be stated that the general case for a vessel in which the damage is not fatal, finds the new position of equilibrium with deeper immersion of the damaged end, a transverse inclination towards the damaged side, and a considerable decrease in the metacentric heights for both longitudinal and transverse inclinations. If the damage and access of water are so serious as to cause foundering, then in many cases as the injured extremity becomes more deeply submerged the transverse stability is necessarily so greatly reduced as to result in the vessel being capsized either before or at the instant of foundering. Experience with actual ships and experiments with models have confirmed these deductions from calculations for the stability of ships injured by collision.

Stability of Ships when launched.—Ships are usually launched in an incomplete condition, and when afloat have a less mean draught of water than is reached subsequently in actual service. Curves of stability for the launching condition were not constructed prior to 1883, when accidents which occurred at the launch of certain vessels led to more extended investigations, and yielded interesting results to which reference may be made.* Fig. 65 contains a few examples of curves of stability for ships as launched. The curve AAA repre-

* See the "Report on the *Daphne* disaster," by Sir Edward Reed; Parliamentary Paper, C 3764—1883; also a paper by Mr. Biles in the *Transactions*

of the Institution of Engineers and Shipbuilders in Scotland for 1883. The curves in Fig. 65 are either taken from or based upon these publications.

sents the condition of the *Daphne*, which capsized in launching. The metacentric height was estimated for the launching condition at 4 inches. The curve BBB represents the condition of a large steamer which took a very heavy list to starboard after getting afloat; her metacentric height was estimated at six-tenths of a foot. The curve

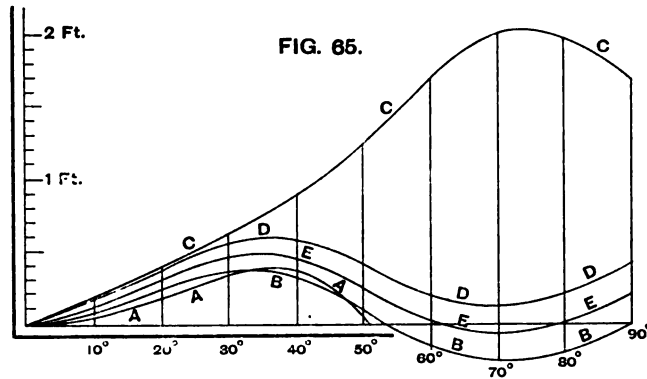

CCC represents another large vessel having nearly the same metacentric height in launching as the second example, but a much better curve of stability; she was safely launched. The curve DDD shows what the curve BBB would become if the total weight remained unaltered, but the centre of gravity were *lowered four-tenths of a foot*, so as to make the metacentric height about 1 foot.

The features common to most ships in launching condition are, extremely light draught, great relative height of freeboard, a low position of the centre of buoyancy (consequent on the light draught), a considerable vertical distance between the centre of gravity and the centre of buoyancy, and (commonly) a high position (in the ship) of the metacentre. Shipbuilders have it in their power to vary the vertical position of the centre of gravity and the draught by putting ballast on board; the other conditions they practically have to accept. Ordinarily they are content to secure such an amount of *stiffness* as experience indicates to be desirable for vessels of the class and size about to be launched. Having approximated to the launching draught and trim, the corresponding position of the metacentre is known; that of the centre of gravity is also approximately determined, and then the ship is ballasted if thought necessary. For special or novel types it may be desirable to go further; and the practice of constructing "cross-curves of stability," described hereafter, enables the stability for the launching draught to be rapidly determined at various angles of inclination. Even in such cases the amount of metacentric height to be secured for safe launching is a

governing condition. Taking the curves BBB and DDD, we find an illustration of this statement. Lowering the centre of gravity less than 5 inches adds 50 per cent. to the maximum righting moment (at about 35 degrees inclination); and converts a zero of righting moment on the curve BBB at 52 degrees of inclination into a positive righting moment not much less than the maximum righting moment on BBB, while instability is not reached up to 90 degrees. While recognizing the interest of these extended inquiries into the stability of ships at launching draughts, it will be obvious, therefore, that one great practical lesson derivable therefrom is the danger of unduly diminishing metacentric heights. If an error is made, it should rather be on the side of greater stiffness than is absolutely necessary; in other words, rather more ballast should be used than the approximate calculations may show to be desirable. It has been suggested that at least *one foot* of metacentric height should be obtained for safe launching, and that curves of stability should be constructed in special cases. General practice appears to proceed very much on the earlier lines above described.

The righting moment of a ship being represented by the product of her weight into the ordinate of the curve of stability corresponding to any angle of inclination, it follows that the smallness of the weights of ships when launched makes them very liable to be inclined by weights on board which can readily shift, or by external forces. Precautions are both usual and necessary in order to prevent the shifting of weights, and many accidents have been due to the neglect of such precautions.

The curve EEE, Fig. 65, shows the change from BBB if the metacentric height were 0.8 foot instead of 0.6 foot. It has been drawn to illustrate an interesting case of stability for some ships at very light draught, and it will be seen that the vessel would then be in stable equilibrium when upright, and again at nearly 80 degrees of inclination, while at 60 degrees (where EEE crosses the base-line) she would be in unstable equilibrium. At 90 degrees there is a considerable righting moment. This case of variation in stability for ships at very light draught had not been investigated until the accidents in launching above mentioned took place. It had, however, been fully discussed by Atwood in a paper read before the Royal Society in 1796, for floating bodies of square section having the centre of gravity in the centre of figure. The contrast between the curve EEE in Fig. 65 for a ship at a very light draught, and the curve 9 in Fig. 62 for a laden ship initially unstable, is worth noting.

Cross-curves of Stability.—In the preceding illustrations many examples will be found of curves of stability for the same ship in two extreme conditions—"fully laden" and "quite light." For

war-ships these two extremes commonly suffice, the range of draught being moderate, and the conditions of loading fixed. In merchant ships, where variations in draught and stowage may be considerable, it has been found desirable to carry the investigations further, and to make calculations by means of which the curve of stability for any draught of water, within working limits, and any position of the centre of gravity of ship and lading, may be readily constructed. A description will now be given of the so-called "cross-curves of stability," which enable this to be done.*

Reverting to Atwood's formula on p. 127, it will be seen that if the centre of gravity G , Fig. 55, coincided with the centre of buoyancy B_1 , each ordinate of the curve of stability would equal (B_1R) the horizontal component of the transverse movement of the centre of buoyancy corresponding to any angle of inclination. In actual calculations for curves of stability, the successive values of B_1R at certain selected angles of inclination are determined. These values of B_1R , being dependent only on the extent of immersion and form of displacement of the ship, are the same for all possible positions of the centre of gravity G corresponding to a particular displacement.

The term $B_1G \sin a$ in Atwood's formula is, in short, not affected by any other considerations than the distance B_1G , and the value of a .

Suppose the cross-section of a ship to be represented by Fig. 66, the ship being inclined at any angle, a . Let w_1l_1 represent the maximum load-line, for which the volume of displacement is V_1 ;

when the vessel is steadily heeled to the angle a , the new water-line is W_1L_1 , cutting off the same volume of V_1 . When the ship is upright, the centre of buoyancy corresponding to w_1l_1 is b_1 ; at the angle

* Details of the methods of calculating and constructing cross-curves will be found in vol. 25 of the *Transactions* of the Institution of Naval Archi-

itects. An excellent discussion of the whole subject by Mr. Elgar appears in the *Proceedings* of the Royal Society for 1884.

FIG. 66.

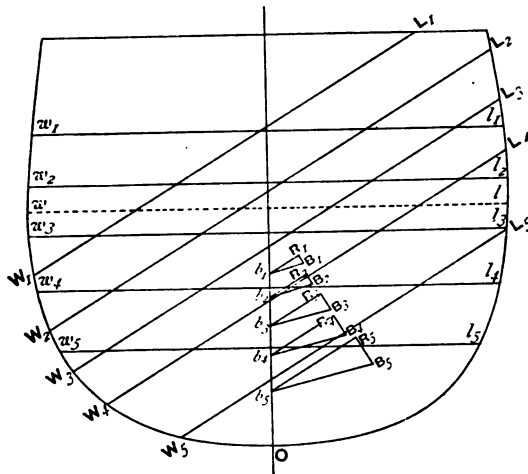

α the new position of the centre of buoyancy is B_1 ; and b_1R_1 is the horizontal component of the transverse motion of the centre of buoyancy produced by the inclination. Four other water-lines, w_2l_2 , w_3l_3 , w_4l_4 , w_5l_5 , when the ship is upright, correspond to volumes of displacement V_2, V_3, V_4, V_5 , and to centres of buoyancy b_2, b_3, b_4, b_5 . For the inclination α these respective volumes are cut off by $W_2L_2, W_3L_3, W_4L_4, W_5L_5$, and the new positions of the centres of buoyancy are B_2, B_3, B_4, B_5 ; while $b_2R_2, b_3R_3, b_4R_4, b_5R_5$ represent the horizontal components of the motions. It will be obvious that for the upright positions, "curves of displacement" (such as Fig. 2, p. 5) give the volumes V_1, V_2 , etc.; and metacentric diagrams (such as Fig. 36, p. 89) give the positions of the corresponding centres of buoyancy. For the inclined water-lines, the positions of B_1, B_2 , etc., are either found by direct calculation, based on the principles above explained, or else, for any inclined water-line chosen, a calculation is made of the volume that water-line cuts off, and the position of its centre of buoyancy. A "mechanical integrator" of great ingenuity, devised by Dr. Amsler (the inventor of the planimeter), enables these calculations to be very rapidly performed; and the instrument is now largely used by naval architects, as a substitute for laborious arithmetical processes.* Next a diagram is constructed of the character shown in Fig. 67. A

FIG. 67.

base-line OWW_1 is taken; O corresponds to the point O in Fig. 66, and is the zero of draught. The draughts of water corresponding to the upright water-lines w_1l_1, w_2l_2 , etc., are next set off (to any selected scale) on the base-line, measuring from O ;

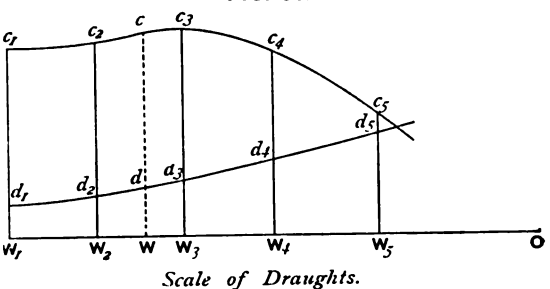

Ordinates of c_1, c_2, c_3, \dots represent $Disp! \times bR$.
 „ „ d_1, d_2, d_3, \dots „ bR .

W_1, W_2, W_3 , etc., represent these draughts; ordinates are drawn at the points so fixed. The length W_1d_1 , Fig. 67, represents (to scale) the measurement b_1R_1 , Fig. 66; W_2d_2 , Fig. 67, represents b_2R_2 , and so on. The length W_1c_1 represents to scale the product $V_1 \times b_1R_1$; W_2c_2 represents the product $V_2 \times b_2R_2$, and so on. Through the points c_1, c_2, c_3 a curve is drawn, and through the points d_1, d_2, d_3 another curve. Then for any water-line, such as wl , Fig. 66,

* For a description of the instrument and its uses, see vol. 25 of the *Transactions* of the Institution of Naval Architects.

for which the abscissa measurement is OW in Fig. 67, the measurements of ordinates Wd and Wc to the curves give respectively the values of bR and of the product $V \times bR$. In other words, for the selected angle of inclination α , calculations performed for four or five water-lines, including extreme load and extreme light conditions, enable the quantities mentioned to be determined for any intermediate draught by simple measurements. Sometimes the launching condition is taken as the lightest draught to be calculated for, instead of the minimum draught for actual working conditions. Of the two curves in Fig. 67, $c_1 c_2 c_3$ is the more valuable, since it takes account of the varying displacements, as well as the varying values of bR ; and when the righting moment opposed to external forces is in question, this product has to be considered.

The construction of curves such as those in Fig. 67 has to be carried out for a number of angles of inclination, usually increasing by intervals of 10 to 15 degrees up to the theoretical "beam-end" position, or 90 degrees of inclination to the vertical. All these curves are usually put upon one diagram, each curve, $c_1 c_2 c_3$, etc., being marked with the angle of inclination to which it corresponds. Having drawn these curves once, they remain available for future use at any draught selected within the working limits. The process of constructing the curve of stability for any assigned draught is very simple. The corresponding abscissa value (say oW in Fig. 67) is known, and the ordinate is drawn at the point W . Measuring the length of that ordinate (Wd) to any cross-curve (such as $d_1 d_2$, etc.) corresponding to a certain angle of inclination (α), the value (bR) of the horizontal transfer of the centre of buoyancy is obtained. The distance (bG) of the centre of buoyancy from the centre of gravity is known; hence the value $bG \sin \alpha$ is ascertainable. This operation is repeated for each cross-curve at the same ordinate (OW), and thus successive values of the righting lever (GZ) are obtained. Having these, the curve of stability is constructed in the manner explained above.

Besides the methods which have been mentioned for making estimates of stability at successive angles of inclination, either by direct calculation or by the use of Amsler's integrator, various simple mechanical methods have been devised for approximating rapidly to these results. Some of these are extremely ingenious, but limits of space prevent any further reference to them here. They are chiefly of interest to the naval architect, and rest upon the principles which have been described in the preceding pages.*

* See the description of Captain Blom's method given in "Naval Science," and of Mr. Heek's ingenious Stability Balances given in vols. 26 and 28 of the *Transactions* of the Institution of Naval Architects.

CHAPTER IV.

THE OSCILLATIONS OF SHIPS IN STILL WATER.

IF a ship, floating in still water, has been inclined from a position of stable equilibrium by the action of external forces, and is afterwards allowed to move freely, she will perform a series of oscillations, the range of which gradually decreases, on either side of the position of equilibrium; and will finally come to rest. For practical purposes attention may be limited to the case of the transverse inclinations and oscillations of ships, reckoning from the upright position where they are in stable equilibrium; and, unless specially mentioned, it may be assumed that the following remarks deal only with rolling motions in still water, the other principal oscillations—viz. pitching—not taking place to any sensible extent except in a seaway.

There is an obvious parallelism between the motion of a ship set rolling in still water and that of a simple pendulum moving in a resisting medium. Apart from the influence of resistance, both ship and pendulum would continue to swing from the initial angle of inclination on one side of the vertical to an equal inclination on the other side; and the rate of extinction of the oscillations in both depends upon the resistance, the magnitude of which depends upon several causes to be mentioned hereafter. In what follows, the term "oscillation" will be used to signify a single swing of the ship from port to starboard, or *vice versa*.* The "arc of oscillation" will simply mean the sum of the angles on either side of the vertical swept through in a single swing; for instance, a vessel rolling from 12 degrees inclination to port, and reaching 10 degrees inclination to starboard, would have $(10^\circ + 12^\circ)$ 22 degrees as the arc of oscillation. The *period* of oscillation means the time occupied (in seconds, say) in performing a single swing.

* In the usual mathematical sense an oscillation would mean a double swing, say from port to starboard and back again to port; but the definition in

the text agrees with the practice of the Royal Navy in recording rolling motions, and is therefore followed.

No vessel can roll in still water without experiencing resistance to her motion ; but considerable advantage results from first considering the hypothetical case of *unresisted* rolling, and afterwards adding the conditions of resistance. Rigorous mathematical reasoning may be applied to the hypothetical case, but this is not true of an investigation which takes account of the total resistance experienced by a ship when rolling; and it is necessary to adopt a mixed method when dealing with resisted rolling, superposing, as it were, data obtained from experiments made to determine the effects of resistance, upon the mathematical investigations of the hypothetical case. No endeavour will here be made to follow out either part of the inquiry, as such a course involves mathematical treatment lying outside the province of this work ; but it is possible in popular language to explain some of the chief results obtained, and this we propose to do.

Supposing the rolling of a ship in still water to be unresisted, it may be asked, What is the length of the simple pendulum with which her oscillations keep time, or synchronize? It has been sometimes assumed that the comparison made in the previous chapter between a ship held in an inclined position and a pendulum of which the length is equal to the distance between the centre of gravity and the metacentre held at an equal inclination, will remain good when the ship and the pendulum are oscillating. In fact, it is supposed that the whole of the weight may be concentrated at the centre of gravity (G, Figs. 34 and 35, p. 83), while the metacentre is the point of suspension for the ship in motion as well as for the ship at rest ; but this is an error. If it were true, the stiffest ships, having the greatest heights of metacentre above the centre of gravity, should be the slowest-moving ships. All experience shows the direct opposite to be true. For example, a converted ironclad of the *Prince Consort* class, with a metacentric height exceeding 6 feet, will make twelve or thirteen single rolls per minute, and an American monitor, with a metacentric height of 14 feet, will make more than twenty single rolls per minute, while vessels like the *Hercules* or *Sultan*, with metacentric heights under 3 feet, will only make seven or eight rolls per minute. What is thus shown to be true by experience had been proved nearly a century and a half ago, by the great French writer Bouguer, in his *Traité du Navire*.

The necessity for carefully distinguishing between the cases of rest and motion in a ship may be simply illustrated by means of a bar pendulum (such as AB, Fig. 68) of uniform section, having its centre of gravity at the middle point, G. To hold the pendulum at any steady inclination to the vertical must require a force exactly equal to that required to hold at the same inclination a simple

pendulum of length AG , and of equal weight to the bar pendulum. But if this simple pendulum were constructed, and set moving, it would be found to move much faster than the bar pendulum. The simple pendulum keeping time with the bar, instead of having a length AG equal to one-half of AB , will have a length AK equal to two-thirds of AB ; and it is important to notice the causes producing this result.*

Suppose the pendulum to have reached one extremity of its swing, and to be on the point of returning: at that instant it will be at rest. As it moves back towards the upright, its velocity continually increases, reaching a maximum as the pendulum passes through the upright position, and afterwards decreasing until at the other extremity of the swing it will once more be instantaneously at rest. These changes of velocity, accelerations, or retardations, from instant to instant can only be produced by the action of certain forces; and according to the first principles of dynamics, these changes of velocity really measure the intensity of the forces. For instance, a body falling freely from a position of rest acquires in one second a velocity of rather more than 32 feet per second; at the end of two seconds it has twice as great a velocity; and so on. This "rate of change of velocity"—some 32 feet per second—is regarded as a measure of the *uniform* accelerating force of gravity. For any other accelerating force the corresponding measure is expressed by the ratio which the rate of change of velocity produced by gravity bears to the change of velocity which would be produced by that accelerating force, if its action continued uniform for one second. For accelerating forces which are not uniform this mode of measurement gives a varying rate of change from instant to instant. In the case of the simple pendulum, the bob moves in a circular arc, having a radius equal to the length of the pendulum; hence the *linear* velocity of the bob in feet per second may be expressed in terms of the product of this radius into the *angular* velocity.† Similarly, the

FIG. 68.

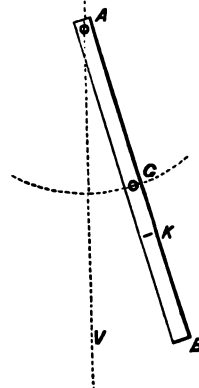

* A *simple* pendulum, as previously explained, is one having all its weight concentrated at one point (the "bob"), and supposed to be hung from the centre of suspension (A, Fig. 68) by a weightless rod. The point K in Fig. 68 is termed the "centre of oscillation," and the bar pendulum will oscillate in the same time, whether it is hung at A or at K.

† The angular velocity may be defined as the angle swept through per second if the motion is uniform, or that which would be swept through per second if the rate of motion existing at any instant were continued for a second. These angles are usually stated in circular measure.

changes in velocity, measuring the accelerating forces, may be expressed in terms of the product of the radius into the changes of angular velocity. These accelerating forces at any instant act at right angles to the corresponding position of the pendulum rod; and so finally we obtain for the simple pendulum:—

$$\left. \begin{array}{l} \text{Moment of accelerating} \\ \text{forces about centre of} \\ \text{suspension} \end{array} \right\} = C \times \text{weight of the bob} \times (\text{radius})^2 \\ \times \text{rate of change of angular} \\ \text{velocity};$$

where C is a constant quantity (viz. $\frac{1}{g}$, nearly—the reciprocal of the velocity per second due to gravity). Hence follows this important principle: for any heavy particle oscillating about a fixed axis the moment of the accelerating forces at every instant involves the product of the weight of the particle by the *square* of its distance from the axis of rotation.

Turning from the simple pendulum to the bar pendulum (Fig. 68), we may consider the latter as made up of a number of heavy particles, and take each separately. For example, take a particle of weight w at a distance x from the axis of rotation (A); the moment of the accelerating force upon it, about the point A, is given by the expression—

$$\text{Moment} = C \times w \times x^2 \times \text{rate of change of angular velocity.}$$

At any instant the change of angular velocity is the same for all particles in the bar-pendulum, whatever may be their distance from A; whence it follows that for the whole of the particles in the bar-pendulum—

$$\left. \begin{array}{l} \text{Moment of accelerating} \\ \text{forces at any instant} \end{array} \right\} = C \times \text{weight of bar} \times k^2 \times \text{rate} \\ \text{of change of angular velocity.}$$

To determine k^2 , we have only to sum up all such products as $w \times x^2$ for every particle in the bar, and divide the sum by the total weight of the bar. Or, using Σ as the sign of summation—

$$k^2 = \frac{\Sigma(wx^2)}{\text{weight of bar}}$$

Turning to the case of a rigid body like a ship, oscillating about a longitudinal axis which may be assumed to pass through the centre of gravity, it is necessary to proceed similarly. Take the weight of each elementary part, multiply it by the square of its distance from the axis of rotation, obtain the sum of the products (which sum is termed the “moment of inertia”), and divide it by the total weight of the ship; the quotient (k^2) will be the square of the “radius of gyration” for the ship when turning about the assumed axis. If the whole weight were concentrated at the distance k from

the axis of rotation, the moment of the accelerating forces and the moment of inertia would then be the same as the aggregate moment of the accelerating forces acting upon each particle of lading and structure in its proper place.

It will be obvious from this popular explanation of established dynamical principles why we cannot assume that a ship in *motion* resembles a simple pendulum suspended by the metacentre, and having all the accelerating forces acting through the centre of gravity. These accelerating forces developed during motion constitute, in fact, a new feature in the problem, not requiring consideration when there is no motion. For a position of rest, it is only necessary to determine the sum of the statical moments of the weight of each element about the centre of suspension, and this sum equals the moment of the total weight concentrated at the centre of gravity. But for motion, there is the further necessity of considering the moment of inertia, as well as the statical moment.

A ship rolling in still water does not oscillate about a *fixed axis*, corresponding to the centre of suspension (A) of the pendulum in Fig. 68; but still her motions are similar to those of the pendulum. At the extremity of a roll, when her inclination to the upright is a maximum, the moment of statical stability is usually greater than that for any other angle within the arc of oscillation, and this is an unbalanced force, tending to restore the vessel to the upright. She therefore begins to move back, and at each instant during her progress towards the upright is subject to the action of a moment of statical stability tending to make her move in the same direction, and consequently quickening her speed. But the moment of stability gradually decreases in amount, and at the upright is zero; the velocity reaching its maximum at that position. On the other side of the upright the statical stability opposes further inclination, and at every instant grows in magnitude; the result is a retardation of speed, and finally a termination of the motion of the ship at the other end of the roll at an inclination to the vertical equal to that from which she started. All this, be it observed, is on the hypothesis of *unresisted* rolling. As a matter of fact, with resistance in operation, it always acts as a retarding force, tending to extinguish the oscillations.

The position of the instantaneous axis about which a ship is turning at any moment, supposing her motion to be unresisted, and the displacement to remain constant during the motion, may be determined by means of a geometrical construction due to the late Canon Moseley. It may be most simply explained by reference to a cylindrical vessel with circular cross-section such as is shown in Fig. 69. If a circle F_2FF_3 be described concentric with the circular

section, and touching the water surface at F, this circle will touch the water-line corresponding to any other inclined position; for all the tangents to this circle cut off from the circular section a segment equal in area to WV L.

FIG. 69.

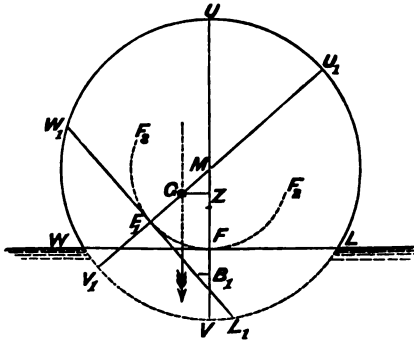

The circle $F_3F_1F_2$ is termed the "curve of flotation," and a right cylinder described upon it as base would have this property: if the water surface is supposed to become rigid and perfectly smooth, and the cylinder of which $F_3F_1F_2$ is a section, is supposed also to have a perfectly smooth surface, and to project before and abaft the ship, carrying her with it while

the projecting ends roll upon the water surface, the conditions for unresisted rolling will be fulfilled. To determine the instantaneous centre, it is then only necessary to consider the simultaneous motions of the point of support, or "centre of flotation," F, and the centre of gravity G. The point F has its instantaneous motion in a horizontal line; consequently it must be turning about some point in the vertical line FM. As to the motion of the centre of gravity, it must be noticed that, resistance being supposed non-existent, the only forces impressed upon the floating body are the weight and buoyancy, both of which act vertically; therefore the motion of translation of the centre of gravity must be vertical, and instantaneously G must be turning about some point in the horizontal line GZ. The point Z, where the two lines GZ and FM intersect, will, therefore, be the instantaneous centre about which the vessel turns.

This simple form of vessel always has the centre of buoyancy B, the centre of flotation F, and the metacentre M in the same vertical line, for any position it can occupy. An ordinary ship presents different conditions, as shown in Fig. 70, where the centre of flotation F does not lie on the vertical line B_1ZM_1 . Here, however, the same principles apply: G moves about some centre in the line GZO; F about some centre in the vertical line FO; the point of intersection O of these two lines fixes the instantaneous axis for the whole ship.

In war-ships the centre of gravity G ordinarily lies near to the water-line (W_1L_1 , Fig. 70) for the upright position; while for oscillations of 12 or 15 degrees on either side of the vertical, the centre of flotation F does not move far away from the middle line A of the load-line section W_1L_1 . In other words, the common case for war-

vessels of ordinary form is that where the instantaneous axis passes through or very near to the centre of gravity. Although the position of the instantaneous axis changes from instant to instant (as its name implies), it is not productive of any serious error in

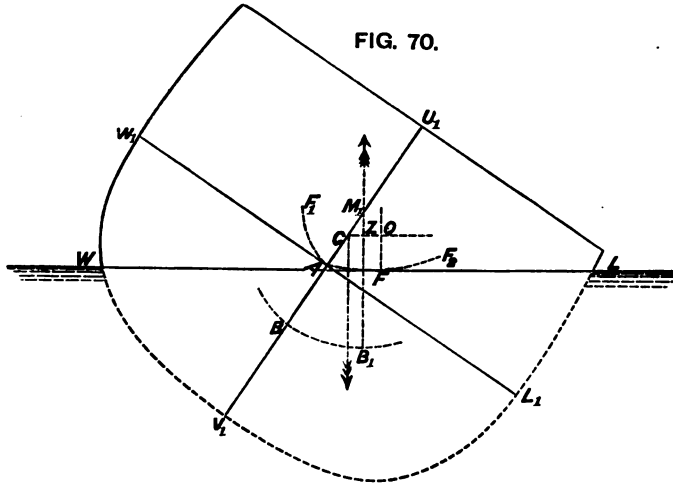

FIG. 70.

most cases to regard the ship as rolling about a fixed axis passing through the centre of gravity. In theoretical investigations no such assumption is necessary, because the principle known in dynamics as the "conservation of the motions of translation and rotation" then becomes applicable. The motion of *translation* of the centre of gravity is considered separately from any motion of *rotation*; this latter motion being then supposed to take place about an axis passing through the centre of gravity. By this means the "period" of an oscillation in still water can be very closely approximated to, although there is no fixed axis of rotation.

It may be interesting to show how the metacentre moves during unresisted rolling, instead of being fixed in space, as is often supposed. Taking once more the cylindrical vessel of circular cross-

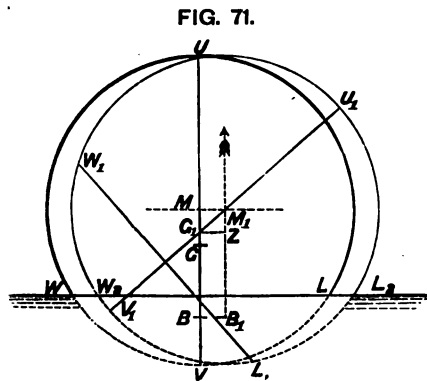

FIG. 71.

section, we have a case where the metacentre is fixed *in the vessel*, but moves *in space* as the vessel rolls. In Fig. 71 the darker circle represents the vessel in her upright position; the lighter one shows

her position at the extremity of the roll. The centre of gravity G moves *vertically*, as explained above, and during the roll rises from G to G_1 , the corresponding position of the metacentre being M_1 . As the ship rolls, therefore, the metacentre sways to and fro horizontally; but in less simple forms it would neither be fixed in the vessel nor have so simple a motion.

Summing up the preceding remarks on unresisted rolling, it appears that the active agent in producing the motion, after the vessel has once been inclined and then set free, is the moment of statical stability; and that the moment of inertia about a longitudinal axis passing through the centre of gravity is also of great importance. Mathematical investigation leads to the following expression for the period of oscillation of a ship:—

Let k = her radius of gyration (in feet).

m = metacentric height (GM) (in feet).

T = period in seconds for a single roll.

$$\text{Then } T = \pi \sqrt{\frac{k^2}{gm}} = 3.1416 \sqrt{\frac{k^2}{gm}}$$

where g (measuring force of gravity) = $32\frac{1}{2}$ feet (nearly) per second. This may be written—

$$T = .554 \sqrt{\frac{k^2}{m}}$$

A fair approximation to the still-water, or “natural” period of oscillation for a new ship can be made by means of this equation. The metacentric height is determined for a war-ship as one of the particulars of the design; and the distribution of the weights is known, so that the moment of inertia can be calculated about the assumed axis of rotation passing through the centre of gravity. This latter calculation is laborious, the weight of each part of the structure and lading having to be multiplied by the square of its distance from the axis; but with care it can be performed with a close approach to accuracy. Calculations of this kind are rarely made, except in connection with novel types of ships, for which thorough investigations are needed in order to be assured of their safety and seaworthiness. As examples of close estimates of natural periods we may refer to the *Devastation* and a monitor of the American type, which were under the consideration of the Admiralty committee on designs for war-ships in 1871. It was estimated that the *Devastation* would have a period of about 7 seconds; the actual period obtained by experiment was $6\frac{3}{4}$ seconds. The estimated period for the American monitor was $2\frac{1}{2}$ seconds; the actual period, $2\frac{7}{10}$ seconds. The formula given for the period supposes the rolling to be unresisted; but the influence of resistance is much more

marked in the extinction of oscillations than it is in affecting the period of oscillation, and this accounts for the close agreement of estimates made from the formula with the results of experiments. This statement may be illustrated by reference to experiments made both in this country and in France. Mr. Froude discovered that the period of the *Greyhound* remained practically the same after exceedingly deep bilge-keels had been fitted, as it was without such keels. Similar results were obtained with a model of the *Devastation* (see p. 177). MM. Risbec and De Benazé, of the French Navy, ascertained that the tug *Elorn*, which had a period of 2·18 seconds without bilge-keels, had that period increased only to 2·25 seconds by the addition of those keels. And yet in all these cases the effect of the keels in extinguishing the oscillations was most marked. The *Elorn* was not merely set rolling in still water, but was also rolled (on specially contrived supports) in dry dock; when her natural period for *unresisted* rolling was found to be 2·03 seconds. This last experiment furthermore confirmed the practical accuracy of the calculation that had been made beforehand of the moment of inertia, and the natural period of this vessel.*

The preceding formula for the still-water period enables one to ascertain approximately the effect produced upon the period by changes in the distribution of the weights on board a ship. Such changes usually affect both the metacentric height and the moment of inertia, and their effects may be summarized as follows:—

Period is increased by—

- (1) Increase in the radius of gyration ;
- (2) Decrease in the metacentric height.

Period is decreased by—

- (1) Decrease in the radius of gyration ;
- (2) Increase in the metacentric height.

“Winging” weights—that is, moving them out from the middle line towards the sides—increases the moment of inertia and tends to lengthen the period. The converse is true when weights—such as guns—are run back from the sides towards the middle line. Raising weights also tends to decrease the moment of inertia, if the weights moved are kept below the centre of gravity; whereas if they are above that point, the corresponding change tends to increase the moment of inertia. But all such vertical motions of weights have an effect upon the position of the centre of gravity, altering the metacentric height, and affecting the moment of inertia by the

* For particulars of these valuable experiments see the *Memoire* presented by Messrs. Risbec and De Benazé to the Academy of Sciences in 1873; this is reprinted in *Naval Science* for 1874 and 1875.

change in the position of the axis about which it is estimated. It is therefore necessary to consider both these changes before deciding what may be their ultimate effect upon the period of rolling. The principles stated above will enable the reader to follow out for himself the effect of any supposed changes in the distribution of the weights. One or two examples may be given. A ship of 6000 tons' weight has a metacentric height of 3 feet and a period of 7 seconds; a weight of 100 tons is raised from 15 feet below the centre of gravity to 15 feet above. In consequence of the transfer of the weight, the centre of gravity will be raised, and we have—

$$\text{Rise of centre of gravity} = \frac{100 \text{ tons} \times 30 \text{ feet}}{6000 \text{ tons}} = \frac{1}{2} \text{ foot.}$$

$$\text{New value of GM} = 3 - \frac{1}{2} = 2\frac{1}{2} \text{ feet.}$$

Originally, according to the formula for the period—

$$7 = .554 \sqrt{\frac{k^2}{3}}$$

$$k = \frac{7}{.554} \sqrt{3} = 22 \text{ (nearly).}$$

The rise in the centre of gravity slightly alters the position of the axis about which the ship is considered to revolve, and this produces a change in the moment of inertia; but the change is so small that it may be neglected.

Then, after the weights are moved, the period T will be given by the equation—

$$T = .554 \sqrt{\frac{k^2}{2\frac{1}{2}}}$$

$$\therefore \frac{T}{7} = \sqrt{\frac{3}{2\cdot5}} = 1\cdot1$$

$$\therefore T = 7 \times 1\cdot1 = 7\cdot7 \text{ seconds (nearly).}$$

The decrease of 6 inches in the metacentric height thus lengthens the period about 10 per cent.

As a second case, suppose weights amounting in the aggregate to 100 tons, placed at the height of the centre of gravity to be "winged" 15 feet from the middle line; their motion, being horizontal, does not affect the position of the centre of gravity.* Then we have—

* The expressions for changes in the moment of inertia produced by winging weights not originally at the middle line, nor placed at the height of the centre of gravity, can be easily formed; it is only

necessary to determine for each position the actual distances of the weights from the axis passing through the centre of gravity.

$$\begin{aligned} \text{Original moment of inertia} &= 6000 \times k^2 \\ \text{Additional moment of inertia} &= 100 \times 15^2 = 22,500 \\ \therefore \text{New moment of inertia} &= 6000 \times k^2 + 22,500 \\ (\text{New radius of gyration})^2 &= \frac{6000 \times k^2 + 22,500}{6000} \\ &= k^2 + \frac{15}{4} \end{aligned}$$

$$\text{Originally, 7 seconds} = .554 \sqrt{\frac{k^2}{3}} \quad (1)$$

$$\text{Now } T = .554 \sqrt{\frac{k^2 + \frac{15}{4}}{3}} \quad (2)$$

$$\text{Therefore } T = 7 \sqrt{1 + \frac{15}{4k^2}}; \text{ also } k^2 = 475$$

$$\begin{aligned} \therefore T &= 7 \sqrt{1 + \frac{15}{1900}} = 7 \times 1.004 \\ &= 7.028 \text{ seconds.} \end{aligned}$$

This alteration in period is very slight, as compared with that produced by the supposed transfer of weight in a vertical sense, and furnishes an illustration of the much greater changes rendered possible by alterations of metacentric heights than by changes in the moments of inertia.

It is important to remark that in the mathematical investigation upon which the formula for the period of oscillation is based, it is assumed that there is no sensible difference between the time occupied by the ship in swinging through large or small arcs. Within a range of, say, 12 or 15 degrees on either side of the vertical in high-sided ships—for which range the metacentric method of estimating the stability gives fairly accurate results—this condition has been proved by direct experiment to be fulfilled very nearly in vessels of ordinary form. For example, the *Sultan* was rolled in still water until an extreme inclination of nearly 15 degrees on either side of the upright was reached, and then allowed to come to rest, the observations being continued until the extreme inclination attained was only 2 degrees; but the period of rolling through the arc of 30 degrees was practically identical with that for the very small arc of 4 degrees. This noteworthy fact is usually expressed by the statement that the rolling of ordinary ships is *isochronous* within the limits named above.

For larger angles of oscillation such ships would probably have a somewhat longer period than for the small oscillations, and it is possible to approximate to this increase. But as yet direct experiment has not been applied to determine the actual periods when

high-sided ships swing to 20 or 30 degrees on either side of the vertical; and the case is one which can be best dealt with by means of model experiments in the manner described on p. 167. Vessels of low freeboard or exceptional form may not be isochronous through arcs of oscillation so large as those named for ordinary vessels; and the reasons for this difference will be understood from the remarks made hereafter. For unresisted rolling the theoretical condition for isochronism may be very simply stated:—Within the limits of inclination to the vertical, for which the statical righting moment varies directly as the angle of inclination, the rolling of a vessel will be isochronous. In other words, if the curve of stability is practically a straight line for a certain distance out from the upright, the rolling will be isochronous within the limits of inclination fixed by that distance.

Dynamical Stability.—Before concluding these remarks on the hypothesis of unresisted rolling, a brief exposition of the principles of *dynamical stability* must be attempted. On the assumption that no account shall be taken of the effect of fluid resistance, dynamical stability may be defined as the “work” done in heeling the ship from her upright position to any angle of inclination; the amount of work done, of course, varying with the inclination. Work, it need hardly be said, is here used in its mechanical sense of a pressure overcome through a distance; for example, a ton raised one foot may be taken as our unit of work, and then to raise 100 tons through a foot, or a ton through 100 feet, will require 100 units of work, or “foot-tons.” It has been shown how to estimate the moment of the couple for statical stability at a given angle; and if the vessel is gradually inclined beyond that angle, the forces inclining her must do work depending upon the righting couples corresponding to the successive instantaneous inclinations, as well as to the ultimate angle attained. In short, it is easy to determine the dynamical stability, when the variations in statical stability are known, and the curve of stability has been constructed.

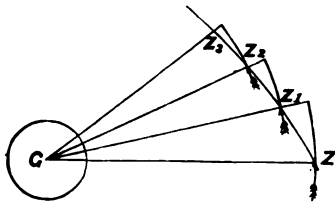

A simple illustration may make this clearly understood. A man is pushing at the end of a capstan bar (Z , in Fig. 72) with a force P , the centre of the capstan (G) is distant l feet from Z . Then the statical moment of the pressure P about G will equal $P \times l$, and this exactly corresponds to the expression for the moment of statical stability ($D \times GZ$) obtained in the previous chapter. Now suppose the man to push the bar on through an angle A (circular measure); then—

Distance the man walks = $l \times A$;

Work he does = pressure \times distance through which it acts
 = $P \times l \times A$ = statical moment $\times A$.

Next suppose that, as the man pushes the bar round, he moves inwards or outwards along it, varying the value of l from instant to instant ; then we shall have a parallel case to that of the ship where the arm of the righting couple varies from angle to angle of inclination. The man walks for a *very small* distance from the first position (GZ, Fig. 72), pushing as before ; then for that very small angle α , GZ will have practically the constant value l , and (as above)—

Work = statical moment (for position GZ) $\times \alpha$.

By the time he has completed the angle A , he has moved in on the bar to the position Z_1 ; let $GZ_1 = l_1$. Then, as he pushes with a constant force P , we must have for a very small angle α from the position GZ_1 —

Work = statical moment (for position GZ_1) $\times \alpha$.

Similarly, for any other position, the work for a very small angle beyond may be expressed in terms of the corresponding statical moment. And what is thus true of the capstan is equally true of a ship ; the work for any small inclination α from a given position is given by—

Work = statical moment of stability for that position $\times \alpha$
 = displacement \times GZ (for that position) $\times \alpha$.

Turning next to any curve of stability (say, to Fig. 56, p. 127), we have a graphic delineation of the values of GZ for every inclination until the vessel becomes unstable. Supposing OP is taken to represent any assigned angle of inclination, and pn drawn very close to PN (the distance Pp corresponding to the very small angle α), the *area* of this little strip (PN np) will graphically represent the product $GZ \times \alpha$. Consequently it follows that on the curve of stability for a ship, reckoning from the upright (O) to any angle of inclination (such as OP), the dynamical stability corresponding to that inclination is represented by the area (OPN) cut off by the ordinate corresponding to that inclination. The total area of the curve of stability therefore represents the total work to be done (excluding fluid resistance) in upsetting a ship.

Bearing this fact in mind, fresh force will be given to the remarks made in the previous chapter as to the comparative influence of beam and freeboard upon the form and range of curves of stability ; and the contrasts exhibited between the curves of stability for various classes of ships given in that chapter, become still greater when the

consideration of their relative total areas is added to that of their range. These are matters upon which any one so desiring may proceed to independent investigation with the materials afforded; and no more will here be said respecting them.

We owe the term, and the first investigation for dynamical stability, to the late Canon Moseley, and his formula differs somewhat in appearance, though not in fact, from that given above. It may be well, therefore, to briefly indicate the chief steps in Canon Moseley's investigation. Starting from the principle that, apart from resistance, the only external forces impressed upon a ship rolling freely would be her weight and buoyancy, he remarked that the work done upon her in producing any inclination might be expressed in terms of the rise in space of the centre of gravity, where the weight might be supposed concentrated, and the fall of the centre of buoyancy, where the buoyancy might be supposed to be centred. Turning to Fig. 55, p. 126, it will be seen that, when the ship is upright, B_1G is the vertical distance between these two centres, whereas in the inclined position their vertical distance becomes equal to BZ . In forming an estimate of the work done in producing an inclination, we are only concerned with the changes in the *relative* vertical positions of these two points; hence we may write, if V = volume of displacement (in cubic feet)—

$$\left. \begin{array}{l} \text{Work done in producing an inclination } \alpha \\ \text{(dynamical stability in foot-tons)} \end{array} \right\} = \frac{V}{35}(BZ - B_1G);$$

also—

$$BZ = RZ + BR = B_1G \cos \alpha + BR;$$

and by the principle of the motion of the centre of buoyancy previously explained (see p. 127)—

$$BR = \frac{v}{V}(g_1h_1 + g_2h_2).$$

Substituting these values in the foregoing expression—

$$\begin{aligned} \text{Dynamical stability} &= \frac{V}{35} \left\{ \frac{v}{V}(g_1h_1 + g_2h_2) - B_1G(1 - \cos \alpha) \right\} \\ &= \frac{1}{35} \left\{ v(g_1h_1 + g_2h_2) - V \cdot B_1G \text{ vers } \alpha \right\} \end{aligned}$$

This is Moseley's formula, and it holds for any angle of inclination. For moderate angles of inclination to which the "metacentric method" of estimating statical stability applies, this formula may be simplified. The point M in Fig. 55 then becomes the metacentre, and the successive positions (B_1 and B) of the centre of buoyancy lie on an arc of a circle having M as the centre. Hence—

$$\begin{aligned} B_1M &= BM \\ BZ &= BM - ZM = BM - GM \cos a \\ B_1G &= B_1M - GM = BM - GM \\ \therefore BZ - B_1G &= GM - GM \cos a \\ &= GM \text{ vers } a \end{aligned}$$

Dynamical stability = weight of ship \times GM vers a .

If a be circular measure of angle of inclination; then for small values of a , vers $a = \frac{a^2}{2}$ nearly. Hence approximately—

$$\text{Dynamical stability for small angles} = \text{weight of ship} \times GM \times \frac{a^2}{2}$$

Since curves of stability have been commonly constructed for ships, instead of using Moseley's formula, the dynamical stability has been much more easily calculated by the method of areas described on p. 159, and its values for different inclinations are often represented by a curve. Within the limits for which the rolling of a ship is isochronous, the curve of stability is a straight line, as explained above. Therefore for any angle a of inclination to the vertical within these limits—

$$\begin{aligned} GZ &= GM . a \\ \text{Statical moment of stability} &= \text{displacement} \times GZ \\ &= \text{displacement} \times GM . a. \end{aligned}$$

And evidently the area of the portion of the curve of stability cut off by the ordinate at the angle a will be given by the expression—

$$\begin{aligned} \text{Area of triangle} &= \frac{1}{2} \times \text{base} \times \text{height} \\ &= \frac{1}{2} \times a \times GM . a. \\ &= \frac{1}{2} GM \times a^2. \end{aligned}$$

So that the amount of work done in heeling the ship from the upright to the angle a , excluding fluid resistance, will be given by the formula—

$$\text{Dynamical stability} = \text{weight of ship} \times GM \times \frac{a^2}{2}$$

This formula is identical with that above obtained, and it holds fairly well for ships of ordinary form up to angles of 10 or 15 degrees to the vertical.

Besides the motion of rotation about an axis passing through the centre of gravity of a ship rolling in still water, there is a motion of translation of the centre of gravity up and down a vertical line; and in the case of the cylindrical vessel (Fig. 71) we have seen how the metacentre moves when the volume of displacement is unchanged. But in few, if any, actual ships can this condition of

constancy of displacement be accurately fulfilled at each instant; and with certain forms of cross-section, such as the Symondite type in Fig. 73, the departure from this condition is very considerable, giving rise to what are called "dipping oscillations" and "uneasy" rolling. Let it be assumed, for example, that the ship in Fig. 73 has rolled until W_1L_1 , which was her upright water-line, has come to the position shown, the motion occupying only 2 or 3 seconds. Then it may, and does, happen that the wedge immersed (LSL_1) will be instantaneously greater than the wedge emerged (WSW_1); for, as already explained, during such a motion, if the roll does not exceed 15 degrees, the instantaneous centre will be nearly coincident with the centre of gravity, and this in war-ships of the Symondite type was near the load water-line. Suppose W_2L_2 to be the water-line at which the vessel would float if steadily held at the assumed inclination; for the instant, the buoyancy of the layer WW_2L_2L constitutes an unbalanced lifting force, which tends to set up a vertical motion in the ship. The ratio which the buoyancy of this layer bears to the total displacement of the ship determines whether this vertical motion will be considerable or not; and it is obvious that with the "pegtop" form of section in Fig. 73 the buoyancy of

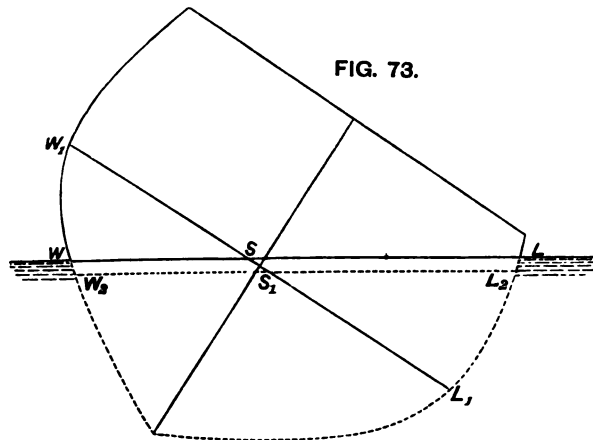

the layer may be great in proportion to the total buoyancy. Moreover, after motion begins, as the water-line W_2L_2 is moved upwards towards WL , there will still remain an unbalanced upward buoyancy, although one decreasing in amount, up to the instant that W_2L_2 reaches the water surface; and consequently, instead of stopping, the ship will be carried on beyond its position of rest, just as a pendulum inclined on one side of the vertical swings over to the other, past its position of rest in the vertical. Hence it follows that, if the vessel were conceived to be kept at the inclination shown, by

forces that left her free to move vertically, she would "dip" upwards and downwards about her statical position of rest until the resistance of the water extinguished her oscillations.

Although ships rolling in still water are not thus held at a definite inclination, they are at each inclination subjected to conditions of a similar character, and they have a period for their dipping oscillations which may be determined approximately, and the ratio of which to that of their rolling oscillations exercises an important influence upon the extent to which dipping proceeds. A single roll, even of a Symondite ship, may not produce much vertical motion, but a succession of rolls may; and the explanation of this fact was thus given by Professor Rankine: "Each roll sets going a fresh series of dipping oscillations, and should the periodic time of rolling happen to be double, quadruple, or any even multiple of the periodic time of dipping, so that each roll coincides with the rising part of the previously existing dipping motion, the extent of the dipping motion may go on continually increasing to an amount limited only by the resistance of the water." In short, when these ratios of the periods of dipping and rolling obtain, the ship is in a condition similar to that of a pendulum which receives periodically a fresh impulse at the end of its swing; and it is a matter of common observation how such an impulse, although in itself not of great magnitude, may by its repeated applications in the manner described lead to considerable oscillations. Dipping motions have not, however, the practical importance of rolling motions, and therefore they will not be further discussed. In vessels of ordinary form these motions are not nearly so extensive as in vessels of the Symondite type, and the reasons for the difference will be obvious.

Resisted Rolling in Still Water.—Turning attention to the effect of fluid resistance upon the rolling of a ship in still water, that resistance may be subdivided into three parts: (1) Frictional resistance due to the rubbing of the water against the immersed portions of the ship, and particularly experienced by the amidship parts where the form is more or less cylindrical. (2) Direct or head resistance, similar to that experienced by a flat board pushed through the water, and chiefly developed against the keel, bilge-keels, deadwood, and flat or nearly flat surfaces lying near the extremities of the ship. (3) Surface disturbance, which involves the creation of waves that move away from the ship, and have continually to be replaced by new-made waves, each creation involving, of course, a certain expenditure of energy, which must react upon the vessel, and be equivalent to a check upon her motion. The aggregate effect of these three parts of the fluid resistance displays itself in

the gradual extinction of the oscillations when the ship rolls freely under the action of no external forces other than gravity and buoyancy. If observations have been made of the rate at which extinction proceeds in any ship, or in a carefully constructed model of the ship (made on a reasonable scale), it is possible to infer from thence the total resistance for that ship, or for one identical with or very similar to her. To estimate by direct calculation the value of the resistance for a ship of novel form, or for any ship independently of reference to rolling trials for similar ships or models, is not, in the present state of our knowledge, a trustworthy procedure. This difficulty in theoretical investigation arises chiefly from the doubtfulness surrounding any estimate of the "wave-making function" for an untried type. It is possible to approximate to the first two parts of the resistance, but the third, as yet, seems outside calculation. For example, when the character of the bottom of a ship is known—whether she is iron or steel bottomed, or copper-sheathed, or zinc-sheathed, and whether clean or dirty—it is possible to obtain the "coefficient of friction" for the known conditions; then knowing the area of the surface upon which friction operates, and the approximate speed with which the ship rolls, the total frictional resistance may be found within narrow limits of accuracy. Similarly, when the "coefficient of direct resistance" for the known speed has been determined by experiments on a board or plane surface, it may be applied to the total area of keel, bilge-keels, dead-wood, etc., and so a good approximation made to the total "keel" or "direct" resistance. But the wave-making function cannot be similarly treated, and so it becomes most important to make rolling experiments in still water, in order that the true value of the resistance may be deduced from the observations. The importance of the deductions arises from the fact that fluid resistance has very much to do with controlling the maximum range of oscillation of a ship rolling in a seaway. This will be explained in Chapter VI.; for the present it is sufficient to remark that, if the rate of extinction of still-water oscillations is rapid, the range of rolling at sea will be greatly limited by the action of the resistance; whereas, if the rate of extinction is slow, resistance will exercise comparatively little control over the behaviour of the ship at sea.

Rolling experiments in still water were recommended strongly by Bouguer in the *Traité du Navire* published in 1746, but their systematic performance was not undertaken until recent years, when a new departure was made in the investigation of the behaviour of ships at sea, chiefly on the initiative of the late Mr. Froude. Many still-water rolling experiments have now been made on typical ships of the Royal Navy and of the French Navy. Some of these have

been conducted by commanding officers, who could add much to the valuable information already recorded if they pursued these experiments more commonly. The objects of these experiments are twofold: (1) to ascertain the period of oscillation of the ship; (2) to obtain the rate of extinction of the oscillations when the vessel is moving freely, and being gradually brought to rest by the action of resistance.

Various means may be employed to produce the desired inclination from the vertical, at which the rolling is left free, and the observations of gradual extinction are commenced. Small vessels have been "hove-down," and suddenly set free. Large ships are usually rolled in still-water by running a large number of men across the deck, their motions being suitably timed so that the amplitude of the oscillations shall gradually increase. It may be well to briefly describe the method, since it may be of value to officers undertaking experiments, and has a bearing also upon some other phenomena of rolling subsequently discussed.

If the men were first massed at the middle line of the deck, and then walked to the side, the transfer of their weight would produce an angle of steady heel, which could be estimated by the method described on p. 108. If, on the contrary, the men were made to run out quickly from the middle line to the side, and back again, their weight would constitute an inclining force of varying amount throughout the period occupied in running out and returning. Suppose the men to run out and back to the middle line in the same time that the ship occupies in making a half-oscillation (from upright to port, or upright to starboard). They will then be back at the middle line at the instant when the ship has reached her first extreme angle of roll from the upright. Running at the same rate, and running "uphill" from the middle line, the men will have run out and home again to the middle line by the instant that the vessel on her return roll has reached the upright. Obviously throughout this return roll the inclining moment due to the weight of the men, acts with the righting moment due to statical stability, and so increases the rolling motion. Continuing the transverse motion of the men in a similar manner, they will always run "uphill" from the middle line, passing the middle of the deck at the end of each roll, and when the ship is upright. The arcs of oscillation will therefore be gradually increased, until a maximum is reached determined by the number of men, the number of runs, their transverse movement, and the resistance to rolling. If the motions of the men are not well timed, similar results will not be obtained; and where there is not free scope for the transverse movements of the men, the experiment involves difficulties. When a

sufficiently large angle of oscillation has been obtained, the men are made to stand still at the middle line, and the observations of rolling and extinction are commenced.

Very large and heavy ships have been thus rolled in still water. Her Majesty's ship *Sultan*, of over 9000 tons, was rolled to $14\frac{1}{2}$ degrees from the upright by the motion of about six hundred men. The *Devastation*, of about equal weight, was rolled to more than 7 degrees from the upright by four hundred men running eighteen times across her deck. The *Inflexible*, of nearly 12,000 tons, was rolled to 6 degrees from the upright; and in her case the transverse movement of the men was not easily accomplished, because of the erections above the upper deck. The *Revenge*, of more than 14,000 tons, was rolled to 8 degrees from the upright, after bilge-keels were fitted, by the motion of nearly 400 men, aided by the training of the heavy guns.

After the men ceased running, careful note is taken of the times occupied by the ship in performing each of several successive single rolls. For vessels of ordinary forms, and for the arcs of oscillation reached in still-water rolling, the periods noted for all the rolls are for practical purposes equal, and the motion is isochronous. Hence if n single rolls are noted in an interval of T seconds, the period is the quotient $T \div n$.

Careful observations are also made of the extreme angles of heel reached at the end of each oscillation, the difference between the successive values marking the rate of extinction. A vessel starting from an inclination of (say) 10 degrees to port only reaches an extreme heel of 9 degrees to starboard, and then rolls back to $8\frac{1}{2}$ degrees to port, gradually coming to rest. These observations are commonly continued until the arc of oscillation has diminished to 2 or 3 degrees. Mr. Froude and M. Bertin both devised beautiful automatic apparatus for recording the rolling motion of the ship in such a manner that the angle of inclination, at each instant of her motion, as well as her extreme angles of heel, can be traced, and the period also determined. But with the aid of the simplest apparatus it is possible to make all the observations needed. In Chapter VII. the common plan of making the observations is described. The gradual degradation in the range of oscillation is represented by means of what are termed "curves of extinction"; examples of these curves, obtained from Mr. Froude's experiments, are given in Fig. 74, for her Majesty's ships *Sultan*, *Inconstant*, and *Volage*. A brief explanation of the construction of these curves will suffice. On the base-line OX are set off equal spaces, each representing an oscillation; and since each oscillation is performed in the same

period, each of these spaces also represents for each ship a certain number of seconds. Any ordinate, drawn at right angles to OX, through the points marking these equal spaces, shows the extreme angle of heel reached at that particular oscillation; and the difference between any two ordinates so drawn shows the loss of range, or extinction of the rolling, in the corresponding number of oscillations. For example, after making twelve oscillations from the extreme angle ($13\frac{3}{4}$ degrees) where the record of observations began, the *Sultan* only reached an extreme angle of 8 degrees, the loss of range in that number of rolls being $5\frac{3}{4}$ degrees. Here the rate of

FIG. 74.

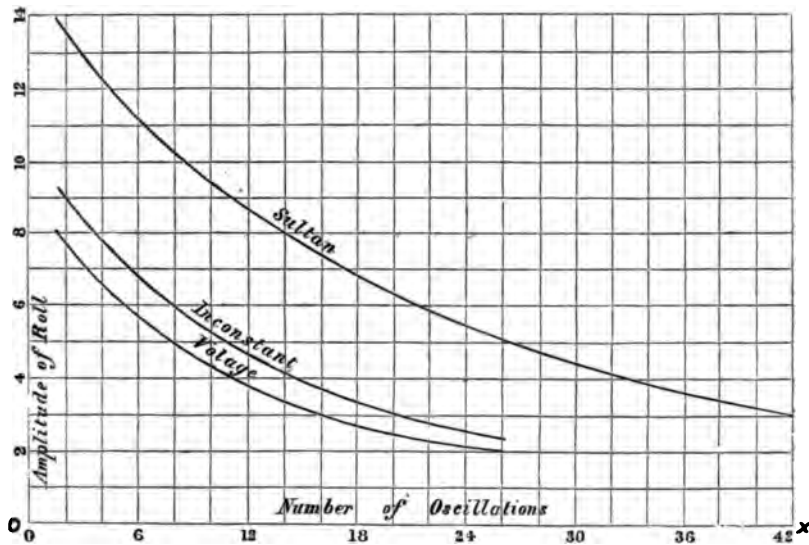

extinction was slow, the vessel having a large moment of inertia, no keel, and only shallow bilge-keels, to assist the extremities in developing resistance to the motion. If there were deeper bilge-keels, the rate of extinction would be more rapid.

Similar rolling experiments have been made with models; and a comparison of the curves of extinction obtained from models with those obtained from the full-sized ships represented by the models has proved that this simpler mode of procedure may be adopted if proper precautions are taken. One of the earliest and best experiments of this kind was made by the late Mr. Froude on a model of the *Devastation*, and when the ship herself was afterwards rolled it was found that her curve of extinction was practically identical with that obtained from the model. There are many obvious advantages in such model experiments. They can be made before the construction of a ship is begun; by means of them it is possible to test the

influence of variations in form, or changes in bilge-keels, etc., upon the curve of extinction; and any critical conditions affecting the safety of a ship when damaged can be investigated. An excellent illustration of the value of these model experiments is found in the case of the *Inflexible*, to which reference will be made again. In that case the model had its lineal dimensions one-twenty-fourth those of the ship; it weighed nearly a ton, was weighted so as to float at the proper draught, had the centre of gravity in the estimated position, and had its moment of inertia so adjusted that it oscillated in still water in a period duly proportioned to the period estimated for the ship. Similar conditions are essential to these model experiments in all cases. The model for a new design simply represents the form, displacement, stability, and period embodied in the design and calculations; and for a completed ship represents those conditions as ascertained by observation and calculation. In all cases, moreover, the model must be made to a reasonable scale; and great care must be taken in recording its behaviour when the rolling experiments are in progress, minute differences for the model becoming exaggerated when the results are increased in scale so as to apply to ships.

In most cases still-water rolling experiments are limited to determinations of the period of oscillation and the curve of extinction; but in some cases they have been carried further, with the intention of determining completely the motion of the ship. One of the most thorough investigations of the kind was that conducted by MM. Risbec and De Benazé, mentioned on p. 155. By means of special apparatus these gentlemen succeeded in obtaining an automatic record of the vertical and horizontal motions of the centre of gravity of the *Elorn*, as well as of her successive arcs of oscillation as her rolling was extinguished by resistance. Their subsequent analysis of these interesting records has advanced considerably our knowledge of some matters, and more particularly of those relating to the motion of the centre of gravity during rolling. When resistance comes into operation, the considerations respecting the instantaneous axis for unresisted rolling (stated on p. 152) require considerable modification. The centre of gravity of the *Elorn*, for example, was found to have motions of translation in the horizontal as well as in the vertical sense, and this is doubtless true generally. Furthermore it appears that while the *Elorn* could not be said to perform her motions of rotation about any fixed axis, there was a point—termed by the experimentalists the *point tranquille*—which traversed the least path during the oscillatory motion of the ship. Their conclusions as to this point are summarized as follows: “In “the *Elorn* the *point tranquille* is always situated between the centre

“of gravity and the water-line. When there are no lateral keels and no ballast, it is near the water-line; when there are no bilge-keels, but the centre of gravity is lowered nearly a foot by ballast, it is very nearly midway between that point and the water-line; lastly, when there is no ballast, but immersed lateral keels, it approaches very near to the centre of gravity, though still above that centre. The position of the *point tranquille* may vary considerably in different ships; more facts are needed in order to fix its approximate position in any case. . . . It is presumable that the *point tranquille* rarely descends below the centre of gravity.”

These conclusions of the French experimentalists are in general accordance with experiments made by the late Mr. Froude in order to determine the “quiescent point,” which was found to lie very close to the centre of gravity in several ships and models. A very simple procedure suffices to determine approximately the vertical position of the “quiescent point” when a ship is rolled in still water. Two or more pendulums, of very short periods, are hung at different heights in the ship; as she reaches successive angles of extreme inclination to the vertical the indications of these pendulums are noted, and the true inclinations of the ship are simultaneously ascertained. From this data, by means of the formula for the error of a pendulum given on p. 278, the vertical position of the “quiescent point” may be ascertained with sufficiently close approach to accuracy. Attempts have been made to frame mathematical expressions for the determination of the position of the instantaneous axis of rotation at any period of the rolling motion; but these investigations have little practical importance; and in estimates for the natural period of ships, it is usual, as previously remarked, to assume that the axis of rotation passes through the centre of gravity.

Rolling experiments have now been made on most classes of war-ships, and their natural or still-water periods have been determined. It may be interesting to summarize the facts. For gun-vessels, gun-boats, torpedo-boats, and small craft, the period for a single roll is from 2 to 3 seconds; these short periods being due to the small radii of gyration consequent upon the small dimensions, and to the necessity for securing a good “metacentric height.” For despatch-vessels, sloops, etc., below the size of corvettes, periods of from 3 to 4½ seconds are common, and 4 seconds is a good average. Un-armoured corvettes and frigates, possessing both sail and steam power, are found to occupy from 5 to 6 seconds in a single roll; but some of the modern types of swift cruisers have periods of 8 seconds, their metacentric heights being less than those of earlier types. Turning to armoured ships, the shortest periods yet observed are found in coast-defence vessels of shallow draught, great proportionate

beam, and large metacentric heights. An American monitor, for example, was found to have a period of 2.7 seconds only, and some of the French floating batteries have periods of 3 to 4 seconds. The first seagoing ironclad in the French navy, *La Gloire*, the English converted ironclads of the *Caledonia* class, the smaller central-citadel turret ships, and the barbette ships of the *Admiral* class, as well as some types of second-class ships, have periods of 5 to 6 seconds. The *Inflexible*, notwithstanding her large dimensions and considerable moment of inertia, has a period of $5\frac{1}{2}$ seconds only, due to her great metacentric height. The *Devastation* of the Royal Navy has a period of $6\frac{3}{4}$ seconds; and first-class rigged ships have periods of 7 to $8\frac{1}{2}$ seconds. The *Sultan* is an example of small metacentric height and large radius of gyration; her period is 8.8 seconds. The *Royal Sovereign* has a period of about 8 seconds. Some of the French ironclads designed about 1868 were less stiff than the *Sultan*, and had a period rather exceeding 10 seconds. This is the longest period for a single roll of a war-ship of which we have any knowledge; and it is to be observed that, in manœuvring in smooth water, the small initial stability of this class is said to have caused some disadvantages, although in a seaway the vessels were remarkably steady.

For merchant ships exact information respecting the still-water periods seems entirely wanting. It will appear, moreover, from the remarks made on p. 91, that there may be considerable variations in the period of any individual ship on different voyages, changes in the character and stowage of the cargoes affecting both the metacentric height and the moment of inertia. From observations made at sea on large and swift passenger-steamers, their periods appear to vary from 8 to 10 seconds. Still-water rolling experiments for merchant ships have not found favour with owners hitherto, probably because of the belief that their performance might involve delays and difficulties; but such experiments might be very simply made, and would furnish valuable information respecting the good or bad stowage of the cargo carried on any voyage. Bouguer suggested this method of inquiry into the character of the stowage so long ago as 1746, and the counsel of the Institution of Naval Architects endorsed the suggestion in 1867. To give practical effect thereto the following course would be followed: Careful note would be taken of the behaviour of a ship on various voyages, and before starting on each voyage a small series of rolling experiments would be made to determine the still-water period of the ship. Hence would be discovered the mean period corresponding to the voyages on which the ship was proved to be well stowed by her good behaviour; and the endeavour in stowing the ship for further service would be to secure approximately the same period as she possessed on the suc-

cessful voyages. This aim might not always be attained, nor would it always be possible to secure the period desired. But in every case, from such rolling experiments, supplemented perhaps by inclining experiments, facts would be obtained enabling some idea to be formed of the probable behaviour of the ship at sea. Apart from such experiments there can be no check upon the character of the stowage; and in many cases where that character has been unsatisfactory the discovery has been made under the trying circumstances of bad weather at sea when changes in stowage were practically impossible. This is a matter well deserving the consideration of shipowners.

The determination of the period for a ship is a matter of simple observation; but the investigations by which the value of the resistance is deduced from curves of extinction, like those in Fig. 74, are more difficult, involving mathematical processes which cannot be reproduced. The principle upon which the investigations proceed may, however, be explained briefly. If a ship started from a certain extreme angle of inclination to the vertical, and her rolling was *unresisted*, she would attain an equal inclination on the other side of the vertical before coming to rest; but when she rolls under the action of resistance she comes to rest when she reaches a smaller inclination on the other side of the vertical. In other words, the "loss of range" per oscillation represents the amount of "mechanical work" done by the resistance during that oscillation, which amount of work can be ascertained by calculating the *dynamical stability* corresponding to the loss of range. Suppose, for example, that a ship starts from an inclination of θ_1 on one side of the vertical, and reaches an inclination of θ_2 on the other side of the vertical. Then, using the approximate formula for the dynamical stability given on p. 161, and writing m for the metacentric height (GM), we have—

$$\begin{aligned} \text{Dynamical stability for inclination } \theta_1 &= W \times m \times \frac{\theta_1^2}{2} \\ \text{'' '' '' } \theta_2 &= W \times m \times \frac{\theta_2^2}{2} \end{aligned}$$

Hence dynamical stability correspond- } = $\frac{Wm}{2} (\theta_1^2 - \theta_2^2)$
ing to decrease of range }

$$= \frac{W \cdot m}{2} (\theta_1 + \theta_2) (\theta_1 - \theta_2)$$

$$= \frac{W \cdot m}{2} \cdot \text{arc of oscillation} \times \text{loss of range.}$$

This last expression measures, as explained above, the work done by

the fluid resistance during a single swing of the ship. Moreover, it will be evident that when the curve of extinction for a ship has been determined experimentally, if any value of θ_1 is assumed, all the other quantities in the expression will be known. The value of the work done by the resistance can thus be determined, and some *data* obtained from which to infer approximately the laws which govern that resistance. In Chapter XI. the subject of fluid resistance is dealt with at length, and a few general remarks must suffice here. Fluid resistance to the motion of a floating body, or of a body immersed in it, depends upon the rate of motion. When a flat surface is pushed forwards, the direct or head resistance, corresponding to the velocity, varies with the area of the surface, and with some power of the velocity, and so would also the frictional resistance experienced by a thin board drawn end-on through the water. The usual assumptions have been that for moderate speeds the resistance varied as the *square* of the velocity, that for very low speeds it varied nearly as the first power of the velocity, and for high speeds at a greater power than the square. For such speeds as are common in the rolling of ships, it is probable that the keel and frictional resistances vary nearly as the square of the angular velocity; and this is the law which French investigators agree in applying to the *total effect* of the resistance. Mr. Froude, however, whose experience and labours in this subject, as well as his numerous experiments, gave to his conclusions exceptional authority, considered the results of experiments to place it beyond question that the loss of range was proportional partly to the arc of oscillation, and partly to the square of that arc. According to this law the total resistance consists of two parts, one varying as the square of the angular velocity, the other as the first power. The former comprehends keel and frictional resistances; the latter is mainly represented by surface disturbance. By the analysis of curves of extinction published by French writers, as well as of curves obtained from his own experiments, Mr. Froude gave good reason for accepting his law of resistance.

Ships of ordinary form being isochronous for moderate angles of inclination on either side of the vertical, all their oscillations within limits, say, of 15 degrees on each side being performed in practically the same time, it follows that, as the range of oscillation increases, so will the mean angular velocity increase. Or, as we may say, the mean angular velocity varies as the arc of oscillation. Hence, it is possible to express the effect of the resistance (measured by the loss of range) per roll in terms of the arc of oscillation. For example, if 2θ be written instead of $\theta_1 + \theta_2$, to express the arc of oscillation, we may write—

$$\text{Loss of range} = a\theta + b\theta^2$$

where a and b are constants determined from the still-water rolling experiments. The values of the constants, of course, vary with the character and form of the vessel, the depth of her bilge-keels, and the coefficient of friction. The rate of extinction of the still-water oscillations of any ship decreases as she approaches a state of rest. This is a matter of common observation, and is fully borne out by the curves of extinction in Fig. 74. From the foregoing remarks the explanation of this fact is readily obtained; the greater the range of oscillation, the quicker the motion, and the greater the resistance. Motion and the existence of the retarding force due to resistance cease simultaneously; resistance has, therefore, sometimes been termed a "passive" force, but it nevertheless exerts a very important and beneficial effect upon the behaviour of ships at sea.

The following are a few examples of the values of the constants a and b , determined for ships of the Royal Navy, the angles θ being measured in degrees:—

The first two ships in this table are armoured; the remainder are unarmoured.

Ships.	a .	b .
<i>Sultan</i>	·0267	·0016
<i>Devastation</i>	·072	·015
<i>Inconstant</i>	·035	·0051
<i>Narcissus</i>	·037	·008
<i>Volage</i>	·028	·0073
<i>Inflezible</i>	·04	·008
<i>Revenge</i> (no bilge-keels)	·0123	·0025
„ (with bilge-keels)	·065	·017

As an illustration of the use of the formula, suppose the *Inconstant* to be swinging through an arc of 16° . Here $\theta = 8^\circ$.

$$\text{Loss of range} = \cdot 035 \times 8 + \cdot 0051 \times 8^2 = \cdot 61.$$

That is to say, the vessel would start from an inclination of about $8\cdot3^\circ$ on one side of the vertical, and reach an inclination of about $7\cdot7^\circ$ on the other side.

According to the French authorities the loss of range would be expressed very nearly by—

$$\text{Loss of range} = N \cdot \theta^2$$

for arcs of oscillation exceeding 6° ; which correspond to values of θ exceeding 3° . The following values of N are given on the authority of M. Bertin, of the French Navy, whose labours in

this department of naval science have been most extensive and valuable.*

Ships.	N.
<i>Sultan</i> (English ironclad)	·0045
<i>Suffren</i> (French ironclad)	·0083
<i>Lagalissoniere</i> (ditto)	·0075
<i>Inconstant</i> (English frigate)	·0123
<i>Volage</i> (English corvette)	·0141
<i>Annamite</i> (French transport)	·0170
<i>Hirondelle</i> (despatch vessel)	·015
<i>Elorn</i> (tug)	·016
<i>Navette</i> (tug)	·0109
<i>Crocodile</i> (gun-vessel : bilge-keels)	·033

The preceding coefficients represent the rate of extinction of the rolling in ships having no headway. M. Bertin has conducted experiments for the purpose of ascertaining whether, when a ship is moving ahead and simultaneously rolling, the coefficients vary. The results for the *Navette* were as follows:—

Speed of ship.	Value of N.
Nil	·0109
4 knots	·0123
8 knots	·015

The explanation suggested is as follows: When a ship is under weigh she penetrates at each instant into water not yet disturbed, of which the whole inertia has to be overcome; whereas, when she has no headway and is rolled, similar conditions do not hold, and the inertia of the water is not so great. It is interesting to add that Mr. Froude found in his analyses of the rolling of the *Devastation* in a seaway that the actual resistance was somewhat greater than that inferred from the still-water experiments made under the usual conditions without headway.

In 1895 experiments were made on H.M.S. *Revenge*, of over 14,000 tons, by rolling her in still water when at rest, and when steaming at speeds of 10 and 12 knots. Starting at 5 degrees from

* See various papers on "Waves Science, 1873-1874, and to the *Revue* and Rolling," contributed to *Naval Maritime*, 1877-1880.

the vertical the angles of inclination reached after a certain number of swings were as follows :—

SPEED OF SHIP.

	Nil.	10 knots.	12 knots.
	Degrees.	Degrees.	Degrees.
After 4 swings	2·95	2·35	2·2
” 8 ”	1·95	1·12	1·05
” 12 ”	1·45	·55	·45
” 16 ”	1·15	·20	·25

The increased rate of extinction resulting from headway was thus conclusively demonstrated on a large scale.

The value or correctness of experimental data obtained by rolling ships is in no way affected by the divergence of opinion between English and French writers as to the mathematical treatment of curves of extinction and the mode of expressing the fluid resistance in terms of the angular velocity. The discussion of this question led Mr. Froude into a full investigation of the actual resistances of certain typical ships. Not content with obtaining the aggregate value of the resistances for these ships, he separated them into their component parts, assigning values to frictional and keel resistances, as well as to surface disturbance. In doing so, he was led to the conclusion that surface disturbance is by far the most important part of resistance, as the following figures will show :—

Ships.	Frictional.	Keel, bilge-keel, and deadwood.	Total resistance.	Surface disturbance.
<i>Sultan</i>	354	5036	20,000	14,610
<i>Inconstant</i>	140	4060	21,500	17,300
<i>Volage</i>	96	2944	14,100	11,060
<i>Greyhound</i>	120	700	4,700	3,880

The frictional and bilge-keel resistances in this table were obtained by calculation from the drawings of the ships, making use of coefficients for friction and for head resistance which had been previously obtained by independent experiments. The total resistance in each case was deduced from the curves of extinction obtained from still-water rolling experiments. It will be noticed that in no case does the sum of the frictional and keel resistances much exceed one-fourth of the total resistance, while it is much less than one-fourth in other cases. Surface disturbance, was, therefore, credited

with the contribution of *three-fourths* or thereabouts of the total resistance. Waves are constantly being created as a vessel rolls, and are constantly moving away, and the mechanical work done in this way results in a reduction of the amplitude of successive oscillations. Very low waves, so low as to be almost imperceptible, owing to their great length in proportion to their height, would suffice to account even for this large proportionate effect. A wave 320 feet long and only $1\frac{1}{4}$ inch in height would fully account for all the work credited to surface disturbance in the fourth case of the preceding table. The lowness of these waves makes it possible for them to escape notice at the time of an experiment, and disposes of one argument that has been raised against the correctness of the foregoing statements. Moreover, the importance attributed by Mr. Froude to surface disturbance derives considerable support from experiments made on very special forms of ships. For example, in experimenting upon the model of the *Devastation*, it was found that, when the deck-edge amidships was considerably immersed before the model was set free to roll, the deck appeared to act like a very powerful bilge-piece, rapidly extinguishing oscillations. MM. Risbec and De Benazé, of the French navy, also found by experiment that, when bilge-keels were moved high up the sides of a vessel, so that, as she rolled, the bilge-keels emerged from the water and entered it again abruptly, their effect became much greater than when they were more deeply immersed; as one would anticipate from the increased surface disturbance that must exist when the bilge-keels are so high on the sides. Experience with the low-freeboard American monitors furnishes further support to this view; immersion of the deck and the existence of projecting armour developing greatly increased resistance—a circumstance which undoubtedly tells much in favour of these vessels, and assists in preventing the accumulation of great rolling motions.

The figures in this table also indicate the large proportionate effect of "keel" resistance as compared with frictional resistance. It has already been explained that this direct or keel resistance is experienced by the comparatively flat surfaces of deadwoods, keels, bilge-keels, etc. Now, it will be obvious that the underwater form of a ship has to be determined chiefly with reference to considerations of propulsion and stability, and that the naval architect can only pay attention to the influence which that form may have upon the resistance to rolling when he has satisfied these primary requirements. But while the shape of the hull proper is thus dealt with, the actual resistance to rolling may often be considerably influenced by fitting such appendages as keels, bilge-keels, etc. The extent to which the influence of these appendages will be felt depends upon

several conditions; such, for example, as their area, their position on the bottom, the period of the ship, her form, and her moment of inertia. Bilge-keels are the most important appendages in common use, and it may be of interest to examine into their mode of operation.

The evidence in favour of the use of bilge-keels is now unquestionable, but formerly many eminent naval architects regarded bilge-keels with suspicion. Direct experiment and careful observation have mainly produced the change of opinion, showing that bilge-keels will increase the rapidity of the extinction of still-water oscillations, and limit the rolling of ships at sea. One very interesting series of experiments was made by the late Mr. Froude, for the information of the Committee on Designs for Ships of War (1871). A model of the *Devastation* was used for this purpose, and fitted with bilge-keels which, on the full-sized ship, would represent the various depths given in the following table. The model was one-thirty-sixth of the full size of the ship, and was weighted so as to float at the proper water-line, to have its centre of gravity in the same relative position as that of the ship, and to oscillate in a period proportional to the period of the ship. In smooth water it was heeled to an angle of $8\frac{1}{2}$ degrees, and was then set free and allowed to oscillate until it came practically to rest, the number of oscillations and their period being observed. The following results were obtained:—

Model fitted with—	Number of double rolls before model was practically at rest.	Period of double roll.
1. No bilge-pieces	$31\frac{1}{2}$	seconds. 1.77
2. A single 21-inch bilge-keel on each side	$12\frac{1}{2}$	1.9
3. " 36-inch " " "	8	1.9
4. Two 36-inch bilge-keels " "	$5\frac{3}{4}$	1.92
5. A single 72-inch bilge-keel " "	4	1.99

The great advantages resulting from the use of bilge-keels are obvious from this table. It will be noted also that the period of oscillation is lengthened as the resistance becomes increased. Similar results have been obtained in other cases. For example, in the *Elorn* MM. Risbec and De Benazé found the rate of extinction was nearly doubled by fitting bilge-keels. M. Bertin found a yet larger increase in the rate of extinction in certain barges upon which he experimented; and estimated that in some small vessels with deep bilge-keels their effect represented more than 60 per cent. of

the total resistance. In all these cases the vessels were small, their periods of oscillation short, and their moments of inertia comparatively small, all of which conditions tend to enhance the effect of bilge-keels. This will be better understood, perhaps, if the formula is given by which an approximation can be made to the work done by a bilge-keel during the swing of a ship. Assuming the resistance to vary as the square of the angular velocity, and supposing r to be the *mean radius* of the bilge-keel from the axis of rotation (assumed to pass through the centre of gravity), then a mathematical investigation gives—

$$\left. \begin{array}{l} \text{Work done in overcoming resist-} \\ \text{ance of bilge-keel during a} \\ \text{single swing.} \end{array} \right\} = \left\{ \begin{array}{l} \text{area of bilge-keel} \times r^3 \\ \times \frac{4\pi^2}{3T^2} \times \theta^3 \times C_2 \end{array} \right.$$

where T = period for a single swing, and 2θ = arc of oscillation. The constant C_2 is determined by experiment. Mr. Froude adopted 1.6 lb. per square foot with the velocity of 1 foot per second as a fair value for this coefficient C_2 ; and from his published examples we may select an illustration of the use of the formula. For the *Sultan*—

Area of bilge-keels	420 square feet
Value of r	25 feet
θ (circular measure)102
T (in seconds)	8.825

$$\begin{aligned} \therefore \text{Work of keels} &= 420 \times (25)^3 \times \frac{4}{3} \cdot \left(\frac{3.1416}{8.825}\right)^3 \times (.102)^3 \times 1.6 \text{ lb.} \\ &= 1890 \text{ (nearly).} \end{aligned}$$

From the general form of the expression for the work done by bilge-keels, etc., it will be evident that their effect increases—

- (1) With increase in area;
- (2) With decrease in the period (T) of the ship;
- (3) With increase in the arc of oscillation.

Also, having regard to the formula for the period given on p. 154, it will appear that the effect of such keels increases as the moment of inertia is diminished, or the metacentric height increased, both of which variations shorten the period of oscillation for a ship. The influence which can be exercised by the designer upon the period of a ship is, however, commonly limited, for reasons previously stated.

For a given area of bilge-keels the extinctive effect varies with the *cube* of the angle of oscillation, and consequently that effect increases very rapidly as the angles of swing increase. In still

water large angles of oscillation do not occur, but among waves the contrary is true, and it is under these circumstances that the full value of bilge-keels is illustrated.

Increase in the area of bilge-keels adds to their power; and since Mr. Froude proved by actual dynamometric towing experiments on the *Greyhound* sloop-of-war, that only a very trifling increase of resistance was caused by bilge-keels of exceptional depth, even when the vessel was subjected to great changes of trim, there has been no serious objection to their use. War-ships and some classes of merchant ships are now commonly fitted with bilge-keels. Usually one such keel is fitted on each side, near the turn of the bilge, and carried as far forward and aft as may be convenient in view of the external form of the vessel. In some cases two keels have been fitted on each side, but there are objections to the arrangement. Two shallow keels have much less power in extinguishing oscillations than a single deep keel of area equal to the combined areas of the other two (see experiments with *Devastation* model, p. 177); and there is a difficulty, except in large ships, in placing two keels on each side, sufficiently clear of one another without the risk of emersing the upper keel during rolling. The reason for the comparative loss of power in two shallow keels is easily seen. As a bilge-keel swings to and fro with the ship it moves at varying velocities, and impresses accelerating motions on masses of water with which it comes in contact, these accelerations being the equivalents of the resistance. If there be two bilge-keels on each side, the water encountered by one will probably have been set in motion by the other keel, and consequently their combined resistance is less than the sum of the resistances which they would experience if acting singly. On the other hand, the addition of a bilge-keel, instead of using a deeper single bilge-keel on each side, may be the only possible means of increasing resistance in some cases. As regards the emersion of bilge-keels it is necessary to remark that more or less violent blows or shocks are received by such keels as they enter the water again; and even when no structural weakness results, the noise and tremor are unpleasant. The power of side-keels placed near the water-line is very great; for example, in the *Elorn* the effect of such keels was *one-third* greater than that of ordinary bilge-keels. But for the reasons given they are rarely used; and in cases where an overhanging armour-shelf a few feet below the water-line acted as a side-keel, it has been found desirable to "fill-in" under the shelf in order to diminish the shocks of the sea.

Practical considerations usually determine the depths given to bilge-keels. Relatively deep keels require to be strongly con-

structed and attached to the hulls, since their extinctive effect upon rolling must necessarily be accompanied by considerable stresses on the material. Cases have occurred in small composite vessels where bilge-keels have been torn away from their fastenings; and in iron or steel ships bilge-keels of too light construction have been bent by the force of the fluid resistance. In many classes of merchant vessels which have to take the ground, that fact limits the depth of bilge-keels. In vessels of great size, the corresponding limit is fixed by the necessity for compliance with certain extreme dimensions of docks which the vessels have to enter.

It has always been recognised that bilge-keels must exercise some steadying effect even on ships of the largest size and the longest periods. The experimental data available prior to 1895 led to the conclusion that the actual steadying effect obtainable with the deepest keels which could be fitted in battle-ships of the largest dimensions, would not justify their use, in view of increased difficulty in docking. Moreover, previous experience with ships of about the same period of oscillation, not fitted with bilge-keels, had shown that they were exceptionally steady under most conditions of sea. For these reasons it was decided, after full consideration, not to fit bilge-keels on the battle-ships of the *Royal Sovereign* class designed in 1889. Trials at sea with those vessels demonstrated that they had long periods of oscillation—about 8 seconds for a single swing—and in this respect they closely resembled the *Sultan* and other ships having high reputations for steadiness. Under most conditions of sea the *Royal Sovereign* class proved equally steady; but when the critical conditions occurred (which are described in Chapter VI.) when approximate synchronism existed between the wave periods and the periods of oscillation of the ships, considerable rolling took place, and increased oscillation rapidly accumulated. It was decided, therefore, to fit the *Repulse* with bilge-keels as an experiment, and to try her at sea in company with other vessels of the class having no bilge-keels. Under the conditions which previous experience had shown to be conducive to heavy rolling, it was found that bilge-keels 200 feet long, 3 feet in extreme depth, and 1170 square feet in collective area reduced the angles of oscillation of the *Repulse* to about one-half of the corresponding angles for her sister ships. This reduction indicated an extinctive power far exceeding in magnitude that which was due to the bilge-keels treated as plane surfaces oscillating with the ship, and exposed to direct resistance (as explained above). The steadying effect of the bilge-keels being thus demonstrated, it was decided to fit similar keels to all the vessels of the class, and it is now the rule to fit bilge-keels to all vessels of the Royal Navy irrespective of size.

While experience at sea was conclusive, it was necessary to supplement it by still-water rolling experiments, in order to obtain exact information suitable for scientific analysis. The *Revenge* was chosen for this purpose, and she was rolled in different conditions of lading and stability: first without bilge-keels, and afterwards with bilge-keels. These experiments are the most important yet made, both as regards their range and the size of the ship. Some of the results obtained have been given above: it is only possible here to add a few of the more important facts and deductions.* In the lighter experimental condition the *Revenge* weighed about 13,400 tons, and had a metacentric height of $3\frac{1}{4}$ feet. In the deep-laden state she weighed about 14,500 tons, with a metacentric height of about 3·8 feet. In the former condition the bilge-keels lengthened the period for a single swing from 8 seconds to 8·4 seconds. Some indication of the remarkable extinctive power of the bilge-keels will be obtained from the statement that before they were fitted it required from 45 to 50 swings to reduce the angle of inclination to the vertical from 6 degrees to 2 degrees: whereas after bilge-keels were fitted, 8 swings sufficed. Without bilge-keels the ship could be rolled up to 13 degrees to the vertical by moving her heavy barbette guns alone. With bilge-keels nearly 400 men running across her decks aided by the heavy guns moving as before, found it difficult to produce an inclination of 6 to 8 degrees. Analysis of the results shows that the actual extinctive effect of the bilge-keels far exceeds what would have appeared probable on the basis of previous experiment; and that even when placed so deep below the water-line, as in the *Revenge*, bilge-keels produce a marked increase of surface disturbance. Experience has shown that the addition of bilge-keels has caused no sensible reduction in speed, while it has led to increased handiness.

Similarly improved behaviour has been secured by fitting bilge-keels to many important vessels of the British mercantile marine, as well as to war-ships of the French, United States, and other navies. The practice of fitting bilge-keels is becoming universal.

In some seagoing torpedo-boats of shallow draught experiments have been tried with a view to increasing resistance to rolling. One of the most interesting was made in 1888–89 for the Danish Navy, and the results have been published by Lieutenant Hovgård.† Two first-class boats 137 feet long and of 110 tons' displacement were taken. A vertical plate-keel, or "ventral fin," of about 60 square

* For full particulars see a paper Architects for 1895.
 contributed by the Author to the † See *Engineering* of July,
Transactions of the Institution of Naval 1889.

feet in area, was fitted to one. The other had no such addition made. Eighteen men running across the deck rolled the latter boat to a maximum angle of $18\frac{1}{2}$ degrees, but the boat with the "fin" only reached $11\frac{1}{2}$ degrees. As the rolling was extinguished there was equally remarkable evidence of the extinctive power of the "fin." Starting from $8\frac{1}{4}$ degrees of heel, the boat so fitted in ten single swings lost $6\frac{1}{4}$ degrees of heel, whereas the other only lost $4\frac{1}{4}$ degrees. The value of the coefficient a in Froude's formula on p. 172 was thrice as great in the boat with the "fin" as it was in the other boat. Her period for a single swing was 2.38 seconds, as compared with 2.28 seconds in the other boat. When tried at sea, under nearly all conditions, the rolling of the boat with the "fin" was less, and in some cases much less, than that of the other boat. In this experiment the inertia of the boats was small; the resistance to rolling due to their form was, of course, comparatively trifling, and consequently the extinctive effect of the vertical keel was more marked.

In certain classes of war-ships, having large metacentric heights and comparatively short periods of oscillation, another plan has been tried for checking rolling motions. The *Inflexible* of the Royal Navy was the first ship fitted with a "water-chamber" for this purpose. Other central-citadel ships, the barbette ships of the *Admiral* class, and a few merchant ships have been similarly fitted. Although the method is no longer followed in the Royal Navy, a description of its principal features and of the chief experimental results obtained will be of interest. The *Edinburgh* central-citadel turret-ship may be taken as a typical case.* Above the protective deck in that vessel a "water-chamber" was built, 16 feet long fore and aft, with a height of about 7 feet; its breadth could be varied (by bulkheads) from the entire breadth of the vessel at that part (67 feet) to either 51 feet or 43 feet. When the chamber had its full breadth, it could hold 210 tons of water; when the breadth was 51 feet, it could hold 180 tons; when the breadth was 43 feet, it could hold 140 tons. Taking the intermediate breadth, as an example, the chamber was partially filled, and the ship was rolled in still water with 39, 79, and 118 tons of water in the chamber, as well as with the chamber empty. The same number of men ran to and fro in each experiment. With no water in the chamber, an angle of heel exceeding 5 degrees was obtained; but with 79

* For a full discussion of the subject in its theoretical aspects as well as its experimental side, see the admirable papers by Mr. Watts in the *Transactions* of the Institution of Naval Archi-

teets for 1883 and 1885. Mr. Watts and Mr. R. E. Froude conducted all the experiments made on behalf of the Admiralty.

tons of water in the chamber, a heel of less than 3 degrees was reached. This proof of the effect of the free water in checking oscillation was confirmed by letting the men stop running, and noting the behaviour of the ship as her rolling was extinguished. With 79 tons of water in the chamber, a single swing reduced the angle of roll from 3 degrees to 2 degrees; whereas with no water in the chamber, it took six single swings to produce the same result. Further, it was proved that the extinctive effect of the free water varied with its *depth* in the chamber. The best result was obtained with 79 tons, an inferior result with 39 tons, and the worst with 118 tons. Similar observations were made with the narrower chamber and a less weight of water when the ship was rolled. By means of a model of the water-chamber, a very much more extended series of experiments was made than could be conducted on the ship, the rolling being carried to much larger angles. The correspondence in behaviour between ship and model was conclusively demonstrated by test experiments. In this way it was shown that water-chambers exercise a great extinctive effect at small angles of rolling, for which bilge-keels have little influence; further, that at larger angles (up to 12 degrees of heel) a considerable increase in the depth of the bilge-keels actually fitted to the *Edinburgh* would have been needed to give an extinctive effect equal to that of the free water in the chamber. For still larger angles the bilge-keels gained rapidly on the water-chamber. Increase in breadth of the water-chamber was accompanied by a great increase in extinctive effect. Passing from 43 feet to 51½ feet about doubled the effect, and passing from 43 to 67 feet about trebled it. The most effective depth of water was shown to be that which would permit the transfer of the water from side to side as the ship rolled to keep time with the rolling motion of the vessel, the water always moving so as to retard the rolling. This motion of the water to produce the best results should be the reverse of that described for the men running in a still-water rolling experiment. Instead of acting *with* the moment of the righting couple, it should act *against* it during each return roll, and thus retard the motion of the vessel. The speed of a wave travelling across the ship in a water-chamber is principally governed by the depth of the water, and may be roughly expressed by—

$$\text{Speed (in feet per second)} = 5.66 \sqrt{\text{depth of water (in feet)}}.$$

For the *Edinburgh*, when the water-chamber was 51½ feet broad, and contained about 78 tons, the depth was about 3½ feet, the speed of transit about 10½ feet per second, and the time of moving across the 51½ feet as nearly as possible 5 seconds, or identically the period of oscillation of the ship for a single swing when no water was in the

chamber. When only one-half this amount of water was in the chamber, the speed of transit would be only about 70 per cent. as great, and the period of transit about 40 per cent. greater. The motion of the water, therefore, tended to increase the moment of the righting couple due to some angles of inclination, and to quicken the angular motion of the ship. On the contrary, with 118 tons of water, the depth would be about 50 per cent. greater, the speed of transit over 13 feet per second, and period of transit less than 4 seconds; so that the angular motion of the ship would be more effectively retarded and her period of oscillation lengthened. These changes in period are, however, of less importance than the variations in extinctive effect produced by variations in depth of the water in a chamber. For reasons stated above, the use of these water-chambers has been discontinued.

If a weight were moved transversely across a ship as she rolled, and its phases of motion were the converse of those described for the motion of men in a rolling experiment, then it would exercise an extinctive effect resembling that obtained when the water in a chamber has its maximum influence. In other words, if at any moment the moving weight is so placed as to act against the righting moment of statical stability, this virtual diminution of righting moment must diminish the rolling. Various attempts have been made to utilize this idea; most of them have failed because no efficient controlling apparatus has been devised which would secure the appropriate motions of the weight, more particularly in a sea-way. Failure in this respect might result, of course, in increased rolling and possible danger. Mr. Thornycroft has succeeded in solving this difficult problem, and has given proof of his success by the behaviour of a yacht fitted with his apparatus. This vessel is about 230 tons in displacement, and has about 4 to 4½ feet of metacentric height. Yet a moving weight of only 8 tons capable of being moved athwartships through so moderate a distance that the yacht heels about 2 degrees, has proved capable of diminishing the rolling among waves by about one-half. It will be obvious that the great stiffness of this yacht made her less suitable for applying the system than a vessel with moderate metacentric height would have been. Had she been half as stiff, then half the weight moved through the same distance would have been equally effective, or the existing appliances would have still further steadied her. Moreover, the quickness of her period in consequence of her great stiffness and small inertia made the arrangement of the controlling gear much more difficult than it would have been in a slower moving vessel. The experiment was therefore made under crucial conditions, and its success is the more remarkable on that account.

It is possible that the system may receive practical application, especially in cases where the designer is prevented by other and paramount considerations from securing long periods of oscillation and consequent steadiness. On the side of the mechanical controlling gear Mr. Thornycroft has exercised great skill and ingenuity, the gear being automatic in its action, and practically incapable of error. Into a description of this gear it is not possible to enter.*

From the foregoing remarks it will appear that there are essential differences between the case of free water present in large quantities in one or more compartments of the hold of a ship, and that of the comparatively small quantities of free water carried for steadying purposes in the specially constructed closed chambers of iron-clads. In the preceding chapter the effect of free water upon statical stability has been dealt with, and its possible dangers explained. Common experience proves that the presence of large quantities of free water in the hold of a ship affects her rolling, is always objectionable, and may be dangerous. The rule above stated for speed of transit of the contained water from side to side in terms of the depth of water, indicates how rapid the transference may be when the depth is considerable; and it will be obvious that the period of oscillation may be sensibly affected, while heavy blows may be delivered on decks, bulkheads, and other portions of the structure. Considerable damage has been done in some cases where water-ballast has been carried in large tank-compartments of considerable depth, and the surface has been made free either by leakage or by failure to fill the compartments. In many classes of ships—and merchant ships especially—the stiffness is so moderate as to make the use of any tank or chamber containing free water undesirable.

The case of a ship where damage to the skin throws certain portions of the interior into free communication with the sea requires to be briefly noticed. An extreme illustration is found in the hypothetical case of a central-citadel ironclad with the light portions of the sides before and abaft the armoured citadel, above the protective deck, freely perforated by shot-holes, or extensively injured by shell-fire. The Report of the *Inflexible* Committee contains some interesting facts which may be quoted. Supposing that ship to be fully laden, with sides intact and a metacentric height of $8\frac{1}{4}$ feet, her period for a single swing was assumed to be 4 to $4\frac{1}{4}$ seconds. From experiments with a model, the curve of extinction in this

* For fuller particulars, see a paper of the Institution of Naval Architects for
by Mr. Thornycroft in the *Transactions* 1892.

intact condition was found to be that shown by the upper curve in Fig. 75.

FIG. 75.

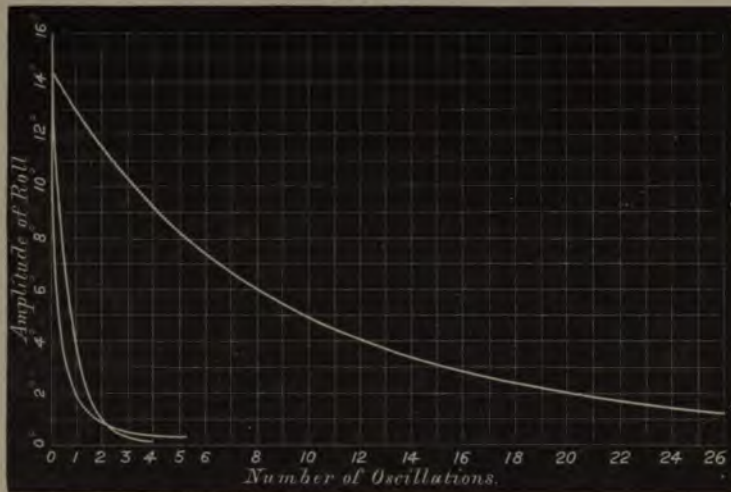

When the ends are riddled the metacentric height falls to 2 feet, the period is increased to 10 seconds, and the curve of extinction is the steepest curve. Supposing the very extreme condition termed "riddled and gutted" to be reached, the metacentric height is $\cdot 24$ foot, the period is 13 seconds, and the curve of extinction is the middle curve. Supposing the ship to be started with a roll having a range of 10° in each of these conditions, then the *losses of range* will furnish a means of comparing the extinguishing effect of the resistance. These losses are given as follows:—

Condition of <i>Inflexible</i> .	Loss of range.
Ship intact	1°
" ends riddled	$7\cdot 8^\circ$
" ends riddled and gutted	$7\cdot 4^\circ$

Rolling in Still Water under the Action of Suddenly Applied Forces.

—Before concluding this chapter it will be desirable to explain briefly the practical use made of the theory of dynamical stability (explained on p. 160), in comparing the safety of ships under the action of *suddenly applied* forces, such as gusts or squalls of wind. These do not, it is true, commonly occur under the condition of smooth water that is assumed throughout the present discussion; but it is convenient to separately consider their effect, and to deal

with the action of the waves independently, for which purpose it is necessary to suppose the water still, while the wind acts on the ship.

Roughly speaking, it may be said that a force of wind which, steadily and continuously applied, will heel a ship of ordinary form to a certain angle will, if it strikes her suddenly when she is upright and at rest, drive her over to about twice that inclination, or in some cases further still. A parallel case is that of a spiral spring; if a weight be suddenly brought to bear upon it, the extension will be about twice as great as that to which the same weight hanging steadily will stretch the spring. The explanation is simple. When the whole weight is suddenly brought to bear upon the spring, the resistance which the spring can offer at each instant, up to the time when its extension supplies a force equal to the weight, is always less than the weight; and this unbalanced force stores up work which carries the weight onwards, and about doubles the extension of the spring corresponding to that weight when at rest.

One point of difference, however, will become obvious between the cases of the ship and the spring. It has been virtually assumed that the vessel, with all sails set, has been becalmed, say by some headland, but, suddenly passing out of this shelter, she is struck by the wind, which heels her over and continues to blow steadily for some time after its sudden application. Now, inclination of the ship at once reduces the moment of the wind-pressure on the sails. Turning to the section, Fig. 33, p. 81, suppose P to be the pressure of the wind, acting horizontally and athwartships, let h be the height of its line of action above that of the equal and opposite fluid resistance P . Then *initially* the inclining moment of the wind on the sails will be given by the equation—

$$\text{Moment of sail power} = P \times h.$$

But the ship begins to heel as soon as the wind-pressure begins to act, and for an inclination α we should have approximately, if the ship were at rest—

$$\text{Moment of sail power} = P \times h \cos^2 \alpha.$$

This law of decrease in the moment of the sails does not profess to be accurate, and is known to be very inaccurate for large angles of inclination; but it is generally accepted as sufficiently near the truth for practical purposes. It must be noted, however, that in this method no account is taken of the reduction of the effective pressure of the wind on the sails produced by their motion to leeward, so that the results obtained therefrom can be regarded only as very roughly approximate. This will be further explained hereafter (see also Chapter XII.).

An illustration of the use of this curve of (cosines)², or "wind-curve," is given in Fig. 76; it is marked WCDW. Two curves of stability (1 and 2), for the *Captain* and *Monarch* respectively, also appear in that diagram; but the ordinates represent statical moments of stability instead of simple GZ values, this arrangement being made in order that the comparison between the two ships may allow

FIG. 76.

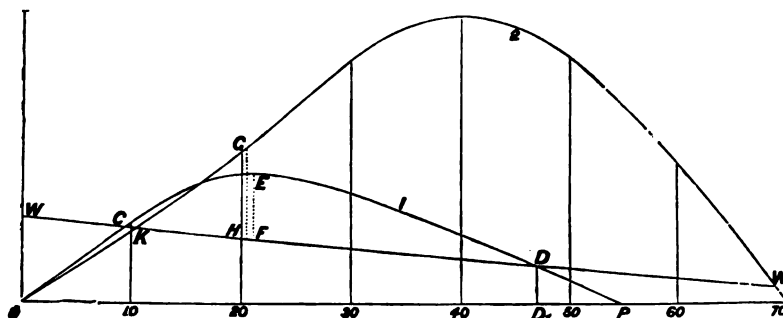

for their different displacements. It will be assumed that they have equal sail-spread and moments of sail, so that one wind-curve will serve for both ships. The force of wind is supposed sufficient to hold the *Captain* at a steady heel of nearly 10 degrees, and the *Monarch* at a slightly greater heel. No matter how far the vessels become inclined, if the wind continues to act upon them, the part of the areas of the curves lying between the wind-curve and the base-line will be absorbed in counterbalancing the steady pressure of the wind. Hence only the areas lying above the wind-curve are available to resist gusts or squalls; and these areas are therefore termed the "reserve dynamical stability." Supposing the reserve to be large, the ship is much safer than if it be small, and on reference to the diagram (Fig. 76) it will be seen how very small was the reserve in the *Captain* when compared with the *Monarch*. Lowness of free-board associated with a moderate metacentric height contributed to give the ill-fated *Captain* a curve of stability of quite a different character from that of any other ship of war carrying masts and sails. Prior to her loss information respecting the curves of stability for various classes of ships was very meagre; but now that numerous and laborious investigations have been made, the very exceptional character of the *Captain* stands out clearly, as may be seen by reference to Figs. 60 and 63. In comparing her with the *Monarch*, as in Fig. 76, we have taken a rigged ironclad below the average as to the range of her stability, but even then the contrast is most remarkable. This will appear from the following statement, published, by authority, soon after the loss of the *Captain*, when

many persons expressed fears, which were groundless, that a similar catastrophe might happen to the *Monarch* :—

	<i>Monarch.</i>	<i>Captain.</i>
Angle at which the edge of the deck is immersed	28°	14°
Amount of righting force in the above position } (in foot-tons of moment) }	12,542	5,600
Angle of maximum stability }	40°	21°
Maximum righting force (in foot-tons of moment)	15,615	7,100
Angle at which the righting force becomes zero } (range of stability) }	69½°	54½°
Reserve of dynamical stability at an angle of } heel of 14 degrees (in foot-tons of work) . . }	6,500	410

The last comparison is the most important as regards safety, and from it one sees how small was the margin of safety of the *Captain* when sailing, as she is reported to have done on the day prior to her loss, at an angle of heel of 14 degrees. Adding to the wind-pressure, the heave of the sea, and rolling oscillations, the reasons of the disaster are obvious.

Fig. 76 also furnishes an illustration of the method by which an approximation can be made to the maximum heel to which a ship is driven by a squall of wind having a certain force if her motion is unresisted. Let WW be the wind-curve as before; the point C, where WW intersects the curve of stability (1) for the *Captain*, determines the steady heel corresponding to the assumed force of wind. The ship is *upright* and at rest when struck, and between the upright and the angle of steady heel the moment of sails continuously exceeds the statical righting moment; hence there is an unbalanced force throughout this part of the motion, storing up work (represented by the area OWC) which is afterwards expended in carrying on the ship until an inclination (EF) is reached (about 20 degrees in this case) making the area (CEF) above the wind-curve equal to the area WOC. The *Monarch* would be driven over to nearly an equal angle by the same squall; GH marks the inclination, the area GKH being equal to the area WOK.

A still more critical case is that where the ship has just completed a roll to windward when the squall strikes her. Accumulation of work then becomes far more serious; the righting moment and the moment of the sails act together as an unbalanced moment all the time that the vessel is moving back to the upright, the condition of things on the leeward side of the upright being similar to that already described. Fig. 77 illustrates this case for the *Captain*. The extreme angle of roll to windward, before the squall strikes the ship, is indicated by the ordinate GHK (8 degrees); the ordinate

LM marks the inclination (40 degrees) she must reach to leeward

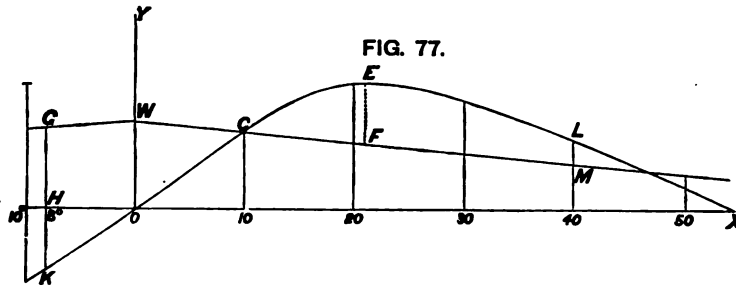

before the reserve of dynamical stability measured by the area CELMC can furnish the requisite amount of work to destroy the motion due to the accumulated work of roll and wind measured by the equal area GKOCWG.* This case shows that even in a calm sea a rigged ship of low freeboard or limited range of stability may run great risk of being capsized if struck by a squall, and illustrates the great advantages possessed by vessels having a large reserve of dynamical stability. Ships of the mastless type are less affected by the action of these suddenly applied squalls and gusts. Their broadsides do not offer sufficient surface to produce any sensible inclination in storms of ordinary severity. For instance, in the *Devastation* it is estimated that, with a storm of wind exerting a pressure of 100 lbs. per square foot, an inclination of only 5 degrees would be produced; but this pressure is about twice as great as that of a hurricane having a speed of 100 knots per hour. Hence a far more moderate range and area of the curves of stability is admissible for such vessels than is proper in rigged ships, and the Admiralty Committee on designs recommended a range of 50 degrees as sufficient for such vessels, regarding them as safe even with a less range of stability.

It is necessary to remark that in the preceding estimate for the heeling effect of squalls no account has been taken of fluid resistance, which would assist in checking the motion, and bring a ship up at a less inclination than has been indicated. When the curve of extinction for a ship is known, and her "coefficients of resistance"

* The wind-curve is the same as in Fig. 76, the corresponding angle of steady heel being nearly 10 degrees; this curve will obviously be symmetrical about the upright position indicated by OY. On the windward side (to the left) of OY it will be noticed that the curve of stability is drawn below the base-line OX; the reason for so doing is that on the right-hand side (to leeward) ordinates

measured above the axis tend to make the vessel move back to windward, so that it is convenient to indicate the contrary tendency existing on the windward side (i.e. a tendency to drive the vessel back to leeward) by drawing the ordinates below the axis. No other feature in the diagram appears to require further explanation.

have been deduced therefrom, it is possible to make the necessary corrections in the estimates for heeling; but this is not commonly done. The method to be followed will be understood from the explanations given (on p. 171) of the manner in which the "work" done by the resistance during a single swing can be measured from the curve of extinction.

Moreover, it must be noted that when a ship is struck by a squall and moves away to leeward, her motion affects both the relative velocity and pressure of the wind on her sails, as well as the height of the centre of the pressure. This matter has been mentioned above, and was fully discussed by the author in a paper read before the Institution of Naval Architects in 1881; but the treatment is of too mathematical a character to be reproduced here. It may be interesting, however, to quote from that paper a few figures illustrating the very great influence which the action of fluid resistance, and the diminution in the moment of wind-pressure produced by the angular motion of the sails, may have upon the angle to which a ship lurches when struck by a squall. Taking the unarmoured wood frigate *Endymion* of the Royal Navy, she is supposed to have reached an extreme inclination of 20 degrees to the windward side of the vertical and to be instantaneously at rest when a squall strikes her; then, by the method explained in Fig. 77, she would be driven over to 39 degrees on the leeward side of the vertical. All other conditions remaining unaltered, except that the effect of the fluid resistance is included, the extreme roll to leeward is found to be reduced from 39 degrees to 31 degrees. And, taking one step further, if allowance is made for the reduction in the effective pressure of the wind on the sails during the roll to leeward, the extreme inclination reached is 22 degrees, or 2 degrees only beyond the initial inclination to windward. The process of "graphic integration" by which these results are obtained is briefly explained on p. 251, and it would enable the problem to be solved completely, were it not for the fact that so little is known of the laws governing the pressure of wind on sails. But enough has been done to show how large is the margin of safety which is provided by the method described in Fig. 77.

Unfortunately, illustrations are not wanting of the possibility of sailing vessels being capsized in smooth water by the action of squalls. Two well-known cases are those of the American yacht *Mohawk* and H.M.S. *Eurydice*.* The *Mohawk* was at anchor off Staten Island in 1876, with sail set, when the squall struck her. Being unprepared for bad weather, the heavy furniture and ballast

* See reports of evidence given before the *Eurydice* Court Martial; also, as to *Mohawk*, see Mr. Dixon Kemp's valuable work on "Yacht and Boat-sailing."

shifted as the yacht heeled over; and, soon after her deck was immersed, the water poured into the cabin and cock-pit, so that all chance of righting was lost. It has been estimated that if the curve of stability of the *Mohawk* were calculated in the usual manner, on the assumption that no weights shifted and no water entered the hold, the angle of maximum stability would have been reached at 30 degrees, and the range would have been about 80 degrees. Under the circumstances described such a curve obviously did not represent the actual conditions of stability of the vessel. In the case of the *Eurydice* also the actual curve of stability at the time the vessel was struck by the squall differed greatly from that made on the ordinary assumptions; and the ports being open virtually reduced the vessel to the condition of a low freeboard rigged ship. The Court Martial recognized these facts in their report; and recorded their opinion that some of the lee-ports being open "materially conduced to the catastrophe." In their judgment also, these ports "having been open was justifiable and usual "under the state of the wind and weather up to the time of the "actual occurrence of the storm."

CHAPTER V.

DEEP-SEA WAVES.

MANY attempts have been made to construct a mathematical theory of wave-motion, and thence to deduce the probable behaviour of ships at sea. The diversity of these theories affords ample evidence, if evidence were needed, of the difficulties of the subject. To an ordinary observer perhaps no phenomena appear less susceptible of mathematical treatment than the rapid and constant changes witnessed in a seaway; but it is now generally agreed that the modern or trochoidal theory of wave motion fairly represents the phenomena, while preceding theories do not. Without attempting any account of the earlier theories, it is proposed in the present chapter to explain, in a simple manner, the main features of the trochoidal theory for deep-sea waves.

Let it be supposed that, after a storm has subsided, a voyager in mid-ocean meets with a series of waves all of which are approximately of the same form and dimensions; these would constitute a single, or independent, series such as the trochoidal theory contemplates. According to this theory the series of waves is regarded as traversing an ocean of unlimited extent, where the depth, in proportion to the wave dimensions, is so great as to be virtually unlimited also. The bottom is supposed to be so deep down that no disturbance produced by the passage of waves can reach it; and the regular succession of the waves requires the absence of boundaries to the space traversed. It is not supposed, however, that an ordinary seaway consists of such a regular single series of waves. On the contrary, more frequently than otherwise two or more series of waves exist simultaneously, over-riding one another, perhaps moving in different directions, and causing a "confused sea," successive waves being of unequal size and varying form. Sometimes the conditions assumed are fulfilled—a well-defined regular series of waves is met with; and from the investigation of their motions it is possible, as we shall see hereafter, to pass to the case of a confused sea. Nor is it supposed that only deep-sea waves are worthy of investigation;

those occurring in shallower water also present notable features, but for our present purpose they are not nearly so important as ocean waves, since these latter so largely influence the behaviour of ships. It will be understood, then, that in what follows, unless the contrary is stated, we are dealing with a single series of regular deep-sea waves.

Any one observing such waves cannot fail to be struck with their apparently rapid advance, even when their dimensions are moderate. A wave 200 feet in length, from hollow to hollow, has a velocity of 19 knots per hour—nearly as fast as the fastest steamships—and such waves are of common occurrence. A wave 400 feet in length has a velocity of 27 knots per hour; and an Atlantic storm wave, 600 feet long, such as Dr. Scoresby observed, moves onward at the speed of 32 knots per hour. But it is most important to note that in all wave motion it is the *wave form* which travels at these high speeds, and not the particles of water. This assertion is borne out by careful observation and common experience. If a log of wood is dropped overboard from a ship past which waves are racing at great speed, it is well known that it is not swept away, as it must be if the particles of water had a rapid motion of advance, and as it would be on a tideway where the particles of water move onwards; but it simply sways backward and forward as successive waves pass.

Before explaining this distinction between the motions of the particles in the wave and the motion of the wave form, it will be well to illustrate the mode in which, according to the modern theory, the wave form or profile may be constructed. Fig. 78 will serve this

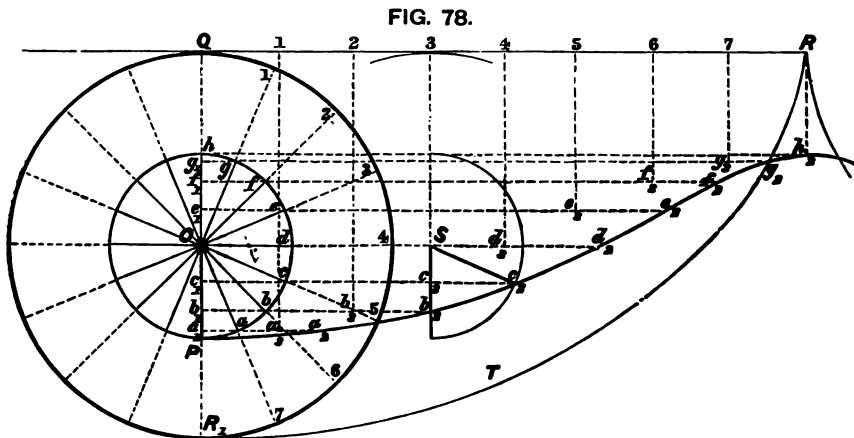

purpose. Suppose QR to be a straight line, under which the large circle whose radius is OQ is made to roll. The length QR being made equal to the semi-circumference, the rolling circle will have

completed half a revolution during its motion from Q to R. If this length QR and the semi-circumference QR₁ are each divided into the same number of equal parts (numbered correspondingly 1, 2, 3, etc., in the diagram), then obviously, as the circle rolls, the points with corresponding numbers on the straight line and circle will come into contact successively, each with each. Next suppose a point P to be taken on the radius OR₁ of the rolling circle; this will be termed the "tracing point," and as the circle rolls, the point P will trace a curve (a trochoid, marked P, a₂, b₂, c₂ . . . h₂ in the diagram) which is the theoretical wave profile from hollow to crest, P marking the hollow and h₂ the crest. The trochoid may, therefore, be popularly described as the curve traced on a vertical wall by a marking-point fixed in one of the spokes of a wheel, when the wheel is made to run along a level piece of ground at the foot of the wall; but when thus described, it would be inverted from the position shown in Fig. 78.

To determine a point on the trochoid is very simple. With O as centre and OP as radius describe the circle Pch. As the rolling circle advances, a point on its circumference (say 3) comes into contact with the corresponding point of the directrix-line QR; the centre of the circles must at that instant be (S) vertically below the point of contact (3), and the angle through which the circular disc and the tracing arm OP have both turned is given by QO3. The angle POc, on the original position of the circles, equals QO3; through S draw Sc₂ parallel to Oc, and make Sc₂ equal to Oc; then c₂ is a point on the trochoid. Or the same result may be reached by drawing cc₃ horizontal, finding its intersection (c₃) with the vertical line S3, and then making c₂c₃ equal to cc₁. In algebraical language, this may be simply expressed. Take Q as the origin of co-ordinates, QR for axis of abscissæ (x).

Let radius OQ = a,

„ OP = b,

angle QO3 = θ,

and x, y = co-ordinates of point c₂ on trochoid.

$$\begin{aligned} \text{Then } x &= c_1c_2 = c_1c_3 + c_2c_3 \\ &= a\theta + b \sin \theta; \\ y &= c_1Q = OQ + Oc_1 \\ &= a + b \cos \theta. \end{aligned}$$

The tracing arm (OP) may, for wave motion, have any value not greater than the radius of the rolling circle (OQ). If OP equals OQ, and the tracing point lies on the circumference of the rolling circle, the curve traced is termed a *cycloid*; such a wave is on the point of breaking. The curve R₁TR, in Fig. 78, shows a cycloid,

and it will be noticed that the crest is a sharp ridge or line (at R), while the hollow is a very flat curve.

A few definitions must now be given of terms that will be frequently used. The *length* of a wave is its measurement (in feet usually) from crest to crest, or hollow to hollow—QR in Fig. 78 would be the half-length. The *height* of a wave is reckoned (in feet usually) from hollow to crest; thus in Fig. 78, for the trochoidal wave, the height would be Ph; or twice the tracing arm. The *period* of a wave is the time (usually in seconds) its crest or hollow occupies in traversing a distance equal to its own length. The velocity (in feet per second) will, of course, be obtained by finding the quotient of the length divided by the period, and would commonly be determined by noting the speed of advance of the wave crest.

Accepting the condition, that the profile of an ocean wave is a trochoid, the motion of the particles of water in the wave requires to be noticed, and it is here the explanation is found of the rapid advance of the wave form, while individual particles have little or no advance. The trochoidal theory teaches that every particle revolves with uniform speed in a circular orbit (situated in a vertical plane which is perpendicular to the wave ridge), and completes a revolution during the period in which the wave advances through its own length. In Fig. 79, suppose P, P, P, etc., to be particles on the

FIG. 79.

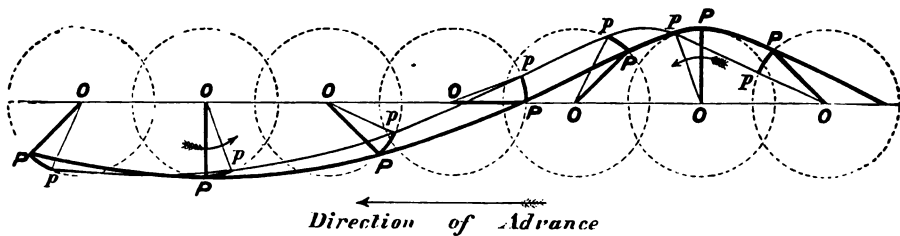

upper surface, their orbits being the equal circles shown; then, for this position of the wave, the radii of the orbits are indicated by OP, OP, etc. The arrow below the wave profile indicates that it is advancing from right to left; the short arrows on the circular orbits show that at the wave crest the particle is moving in the same direction as the wave is advancing in, while at the hollow the particle is moving in the opposite direction. For these surface particles the diameter of the orbit equals the height of the wave. Now suppose all the tracing arms OP, OP, etc., to turn through the equal angles PO p , PO p , etc.; then the points p, p, p , etc., must be corresponding positions of particles on the surface formerly situated at P, P, etc. The curve drawn through p, p, p , etc., will be a trochoid

identical in form with P, P, P, etc., only it will have its crest and hollow further to the left; and this is a motion of advance in the wave form produced by simple revolution of the tracing arms and particles (P).* The motion of the particles in the direction of advance is limited by the diameter of their orbits, and they sway to and fro about the centres of the orbits. Hence it becomes obvious why a log dropped overboard, as described above, does not travel away on the wave upon which it falls, but simply sways backward and forward. One other point respecting the orbital motion of the particles is noteworthy. This motion may be regarded at every instant as the resultant of two motions—one vertical, the other horizontal—except in four positions, viz.: (1) when the particle is on the wave-crest; (2) when it is in the wave hollow; (3) when it is at mid-height on one side of its orbit; (4) when it is at the corresponding position on the other side. On the crest or hollow the particle instantaneously moves horizontally, and has no vertical motion. At mid-height it moves vertically, and has no horizontal motion. Its maximum horizontal velocity will be at the crest or hollow; its maximum vertical velocity at mid-height. Hence uniform motion along the circular orbit is accompanied by accelerations and retardations of the component velocities in the horizontal and vertical directions.

The particles which lie upon the trochoidal upper surface of the wave are situated in the level surface of the water when at rest. The disturbance caused by the passage of the wave must extend far below the surface, affecting a great mass of water. But at some depth, supposing the depth of the sea to be very great, the disturbance will have practically ceased; that is to say, still, undisturbed water may be conceived as underlying the water forming the wave. Reckoning downwards from the surface, the extent of disturbance must decrease according to some law. The trochoidal theory expresses the law of decrease, and enables the whole of the internal structure of a wave to be illustrated in the manner shown in Fig. 80.† On the right-hand side of the line AD the horizontal lines marked 0, 1, 2, 3, etc., show the positions in still water of a series of particles which during the wave transit assume the trochoidal forms numbered respectively 0, 1, 2, 3, etc., to the left of AD. For

* It is possible to construct a very simple apparatus by which the simultaneous revolution of a series of particles will produce the apparent motion of advance; and in lectures delivered at the Royal Naval College such an apparatus was used by the author.

† This diagram we borrow from Mr. Froude's paper on "Wave Motion" in the *Transactions* of the Institution of Naval Architects for 1862; it was one of the first constructed, and is therefore reproduced.

still water every unit of area in the same horizontal plane has to sustain the same pressure: hence a horizontal plane is termed a surface or subsurface of "equal pressure" when the water is at rest.

FIG. 80.

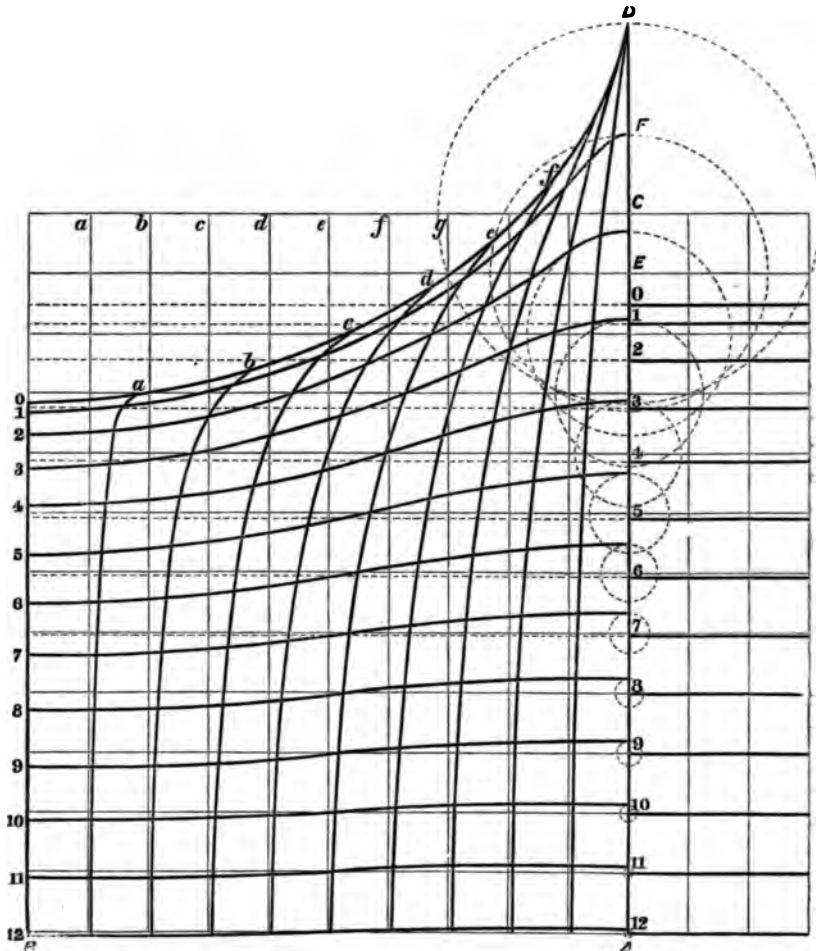

As the wave passes, the trochoidal surface corresponding to that horizontal plane will continue to be a subsurface of equal pressure; and the particles lying between any two planes (say 6 and 7) in still water will, in the wave, be found lying between the corresponding trochoidal surfaces (6 and 7).

In Fig. 80, it will be noticed that the level of the still-water surface (0) is supposed changed to a *cycloidal* wave (0) the construction of which has already been explained; this is the limiting height the wave could reach without breaking. The half-length of

the wave (AB) being called L, the radius (CD) of the orbits of the surface particles will be given by the equation—

$$CD = R = \frac{L}{\pi} = \frac{7}{22}L \text{ (nearly).}$$

All the trochoidal subsurfaces have the same length as the cycloidal surface, and they are generated by the motion of a rolling circle of radius R; but their tracing arms—measuring half the heights from hollow to crest—rapidly decrease with the depth (as shown by the dotted circles), the trochoids becoming flatter and flatter in consequence. The crests and hollows of all the subsurfaces are vertically below the crest and hollow of the upper wave profile. The heights of these subsurfaces diminish in a geometrical progression, as the depth increases in arithmetical progression; and the following approximate rule is very nearly correct. The orbits and velocities of the particles of water are diminished by *one-half*, for each additional depth below the mid-height of the surface wave equal to *one-ninth* of a wave length.* For example—

Depths in fractions of a wave length below the mid-height of the surface wave	}	0, $\frac{1}{9}$, $\frac{2}{9}$, $\frac{3}{9}$, $\frac{4}{9}$, etc.
Proportionate velocities and diameters		1, $\frac{1}{2}$, $\frac{1}{4}$, $\frac{1}{8}$, $\frac{1}{16}$, etc.

Take an ocean storm-wave 600 feet long and 40 feet high from hollow to crest: at a depth of 200 feet below the surface ($\frac{2}{9}$ of length), the subsurface trochoid would have a height of about 5 feet; at a depth of 400 feet ($\frac{4}{9}$ of length) the height of the trochoid—measuring the diameter of the orbits of the particles there—would be about 7 or 8 inches only; and the curvature would be practically insensible on the length of 600 feet. This rule is sufficient for practical purposes, and we need not give the exact exponential formula expressing the variation in the radii of the orbits with the depths.

It will be noticed also in Fig. 80 that the centres of the tracing circles corresponding to any trochoidal surface lie above the still-water level of the corresponding horizontal plane. Take the horizontal plane (1), for instance. The height of the centre of the tracing circle for the corresponding trochoid (1) is marked E, EF being the radius; and the point E is some distance above the level of the horizontal line (1). Suppose *r* to be the radius of the orbits for the trochoid under consideration, and R the radius of the rolling circle: then the centre (E) of the tracing circle (*i.e.* the mid-height of the trochoid) will be above the level line (1) by a distance equal

* See p. 70 of *Shipbuilding, Theoretical and Practical*, edited by the late Professor Rankine; who, with the late

Mr. Froude, did much to develop the trochoidal theory, originally propounded by Gerstner.

to $r^2 \div 2R$. Now R is known when the length of the wave is known: also r is given for any depths by the above approximate rule. Consequently, the reader has in his hands the means of drawing the series of trochoidal subsurfaces for any wave that may be chosen.

Columns of particles which are vertical in still water become curved during the wave passage. In Fig. 80, a series of such vertical lines is drawn (see the *fine* lines a, b, c, d , etc.); during the wave transit these lines assume the positions shown by the *strong* lines (a, b, c, d , etc.) curving towards the wave crest at their upper ends, but still continuing to enclose between any two the same particles as were enclosed by the two corresponding lines in still water. The rectangular spaces enclosed by these vertical lines (a, b, c, d , etc.) and the level lines (0, 1, 2, etc.) produced are changed during the motion into rhomboidal-shaped figures, but remain unchanged in area. The motions of these originally vertical columns of particles have been compared to those occurring in a corn-field, where the stalks sway to and fro, and a wave form travels across the top of the growing corn. But while there are points of resemblance between the two cases, there is also this important difference—the corn-stalks are of constant length, whereas the originally vertical columns become elongated in the neighbourhood of the wave crests, and shortened near the wave hollows.

These are the chief features in the internal structure of a trochoidal wave, and in the following chapter they will be again referred to in order to explain the action of waves upon ships. It is necessary, however, at once to draw attention to the fact that the condition and direction of fluid pressure in a wave must differ greatly

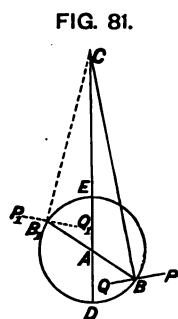

from those for still water. Each particle in the wave, moving at uniform speed in a circular orbit, will be subjected to the action of centrifugal force as well as the force of gravity; and the resultant of these two forces must be found in order to determine the direction and magnitude of the pressure on that particle. This may be simply done as shown in Fig. 81 for a surface particle in a wave. Let BED be the orbit of the particle; A its centre; and B the position of the particle in its orbit at any time. Join the centre of the orbit A with B ; then the centrifugal force acts along the radius AB , and the length AB may be supposed to represent it. Through A draw AC vertically, and make it equal to the radius (R) of the rolling circle; then it is known that AC will represent the force of gravity on the same scale as AB represents centrifugal force. Join BC , and it will

represent in magnitude and direction the resultant of the two forces acting on the particle. Now, it is an established property of a fluid that its free surface will place itself at right angles to the resultant force impressed upon it. For instance, take the simple case of a rectangular box (shown in Fig. 82) containing water, which is made to move along a smooth horizontal plane by the continued applica-

FIG. 82.

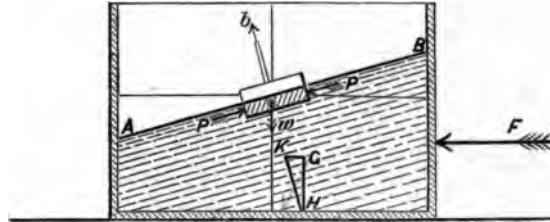

tion of the force F ; then we shall have uniformly accelerated motion, equal increments of velocity being added in successive units of time. In order to compare this force with that of gravity, if f is the velocity added per second of time, and W is the weight of the box and water, we should have—

$$\frac{F}{W} = \frac{f}{g} = \frac{f}{32\frac{1}{2}} \text{ (nearly).}$$

Now, it is well known that under the assumed circumstances of motion the surface of the water in the box will no longer remain level, but will attain some definite slope such as AB in Fig. 82; and it is easy to ascertain the angle of slope. Through any point G draw GH vertical to represent the weight W , and GK horizontal to represent the force F ; join HK , and it will represent the resultant of the two forces, the water surface AB placing itself perpendicular to the line, on the principle mentioned above. The tangent of the angle which the surface AB makes with the horizon will equal the ratio of F to W .

Reverting to Fig. 81, the resultant pressure shown by BC must be normal to that part of the trochoidal surface PQ where the particle B is situated. Similarly, for the position B_1 , CB_1 will represent the resultant force; P_1Q_1 drawn perpendicularly to CB_1 , being a tangent to the trochoid at B_1 . Conversely, for any point on any trochoidal surface in a wave, the direction of the fluid pressure must lie along the *normal* to that surface. Hence it follows that wave motion involves constant changes in the magnitude and direction of the fluid pressure for any trochoidal surface; these changes of direction partaking of the character of a regular oscillation keeping time with the wave motion. At the wave hollow the fluid pressure acts along

a vertical line; as its point of application proceeds along the curve, its direction becomes more and more inclined to the vertical, until it reaches a maximum inclination at the point of inflection of the trochoid; thence onwards towards the crest the inclination of the normal pressure is constantly decreasing until at the crest it is once more vertical. If a small raft floats on the wave (as shown in Fig. 83), it will at every instant place its mast in the direction of

FIG. 83.

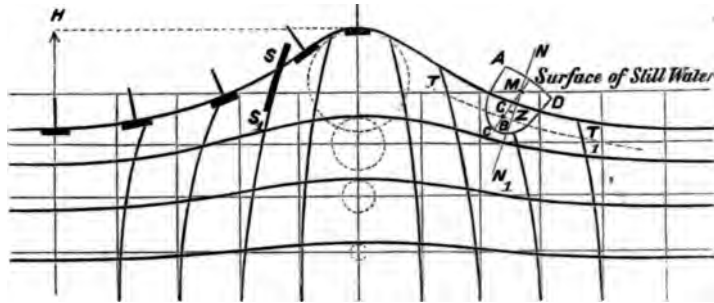

the resultant fluid pressure, and in the diagram several positions of the raft are indicated to the left of the wave crest. These motions of the direction of the normal to the trochoid may be compared with those of a pendulum, performing an oscillation from an angle equal to the maximum inclination of the normal on one side of the vertical to an equal angle on the other side, and completing a single swing during a period equal to half the wave period.

The maximum slope of the wave to the horizon occurs at a point somewhat nearer the crest than the hollow, but no great error is assumed in supposing it to be at mid-height in ocean waves of common occurrence where the radius of the tracing arm (or half-height of the wave) is about one-twentieth of the length. For this maximum slope, we have—

$$\begin{aligned} \text{Sine of angle} &= \frac{\text{radius of tracing circle}}{\text{radius of rolling circle}} \\ &= \frac{\text{half height of wave}}{\text{length of wave} \div 6.2832} \\ &= 3.1416 \times \frac{\text{height of wave}}{\text{length of wave}} \end{aligned}$$

For waves of ordinary steepness all practical purposes are served by writing the circular measure of the angle instead of the sine; hence ordinarily we may say—

$$\left. \begin{array}{l} \text{Approximate maximum wave slope} \\ \text{(in degrees)} \end{array} \right\} = 180^\circ \times \frac{\text{height of wave}}{\text{length of wave}}$$

Take, as an example, a wave for which the dimensions were actually determined in the Pacific, 180 feet long and 7 feet high—

$$\text{Maximum slope} = 180^\circ \times \frac{7}{180} = 7^\circ \text{ (nearly).}$$

The variation in the direction of the normal was in this case similar to an oscillation of a pendulum swinging 7 degrees on either side of the vertical once in every half-period of the wave—some 3 seconds. These constant and rapid variations in the direction of the fluid pressure in wave water constitute the chief distinction between it and still water, where the resultant pressure on any floating body always acts in one direction, viz. the vertical.

But it is also necessary to notice that in wave water the *intensity* as well as the direction of the fluid pressure varies from point to point. Reverting to Fig. 81, and remembering that lines such as BC represent the pressure in magnitude as well as direction, we can at once compare the extremes of the variation in intensity. In the upper half of the orbit of a particle, centrifugal force acts *against* gravity, and reduces the weight of the particle; this reduction reaches a maximum at the wave crest, when the resultant is represented by CE=(R-r). In the lower half of the orbit, gravity and centrifugal force act together, producing a virtual increase in the weight of each particle; the maximum increase being at the wave hollow, where the resultant is represented by CD=(R+r). If a little float accompanies the wave motion, it may be treated as if it were a particle in the wave, and its apparent weight will undergo similar variations. In a ship, heaving up and down on waves very large as compared with herself, the same kind of variations will occur, though perhaps not to the same extent as in the little float. Actual observation shows this to be true. Captain Mottez, of the French navy, reports that on long waves, about 26 feet high, the apparent weights of a frigate at hollow and crest had the ratio of 12 to 8. According to the preceding rules we must then have—

$$\begin{aligned} \frac{R-r}{R+r} &= \frac{8}{12} \\ \frac{2R}{2r} &= \frac{20}{4} \end{aligned}$$

$$R = 5r = 5 \times 13 = 65 \text{ feet.}$$

$$\text{Length of waves (by theory)} = 2\pi R = 6.28 \times 65 = 408 \text{ feet.}$$

This, in proportion to the height recorded, is not an unreasonable length; but, unfortunately, Captain Mottez does not appear to have completed the information required, by measuring the actual length of the waves. The important fact he proved, however, is one that

theory had predicted, viz. that the heaving motion of the waves may produce a virtual variation in the weight of a ship equivalent to an increase or decrease of one-fourth or one-fifth, when the proportions of the height and length of the waves are those common at sea.*

Instead of the raft in Fig. 83, if the motions of a loaded pole or plank on end (such as SS_1), be traced, it will be found that it tends to follow the originally vertical lines, and to roll always toward the crest as they do. Here again the motion partakes of the nature of an oscillation of fixed range performed in half the wave period, the pole being upright at the hollow and crest.

A ship differs from both the raft and the pole; for she has lateral and vertical extension into the subsurfaces of the wave, and cannot be considered to follow either the motion of the surface particles like the raft or of an originally vertical line of particles like the pole. This case will be discussed in the next chapter.

The trochoidal theory connects the periods and speeds of waves with their lengths alone, and fixes the limiting ratio of height to length in a cycloidal wave. The principal formulæ for lengths, speeds, and periods for trochoidal waves are as follows:—

- I. Length of wave (in feet) = $5.123 \times \text{square of period (in seconds)}$
 $= 5\frac{1}{3} \times \text{square of period (nearly)}$.
- II. Speed of wave (in feet per second) . . . } = $5.123 \times \text{period} = \sqrt{5.123 \times \text{length}}$
 $= 2\frac{1}{4} \sqrt{\text{length}}$ (nearly).
- III. Speed of wave (in knots per hour) . . . } = $3 \times \text{period}$ (roughly).
- IV. Period (in seconds) = $\sqrt{\frac{\text{length}}{5.123}} = \frac{4}{9} \sqrt{\text{length}}$ (nearly).
- V. Orbital velocity of particles on surface } = { speed of wave } $\times \frac{3.1416 \times \text{height of wave}}{\text{length of wave}}$
 $= 7\frac{1}{3} \times \frac{\text{height of wave}}{\sqrt{\text{length of wave}}}$ (nearly).

To illustrate these formulæ, we will take the case of a wave 400 feet long and 15 feet high. For it we obtain—

$$\text{Period} = \frac{4}{9} \sqrt{400} = 8\frac{2}{3} \text{ seconds.}$$

$$\text{Speed} = \frac{9}{4} \sqrt{400} = 45 \text{ feet per second.}$$

$$= 3 \times 8\frac{2}{3} = 26\frac{2}{3} \text{ knots per hour.}$$

* See also an article by Lieutenant les Navires a la Mer," *Revue Maritime*, Guyon, "De la Pesanteur Apparente sur 1885.

$$\left. \begin{array}{l} \text{Orbital velocity of sur-} \\ \text{face particles.} \end{array} \right\} = 7\frac{1}{2} \times \frac{15}{\sqrt{400}} = 5\frac{1}{2} \text{ feet per second,}$$

It will be remarked that the orbital velocity of the particles is very small when compared with the speed of advance; and this is always the case. In formula V., if we substitute, as an average ratio for ocean waves of large size,

$$\text{Height} = \frac{1}{20} \times \text{length,}$$

the expression becomes—

$$\begin{aligned} \text{Orbital velocity of surface particles} &= 7\frac{1}{2} \times \frac{\frac{1}{20} \times \text{length}}{\sqrt{\text{length}}} \\ &= 0.355 \sqrt{\text{length}} \end{aligned}$$

Comparing this with Formula II. for speed of advance, it will be seen that the latter will be between six and seven times the orbital velocity.

The periods of waves are most easily observed, and the following table will be useful as giving the lengths and speeds of trochoidal waves for which the periods are known:—

Period.	Length.	Speed of advance.	
		feet per second.	knots per hour.
seconds.	feet.		
1	5.12	5.12	3.03
2	20.49	10.24	6.07
3	46.11	15.37	9.1
4	81.97	20.49	12.14
5	128.08	25.62	15.17
6	184.44	30.74	18.21
7	251.04	35.86	21.24
8	327.89	40.99	24.28
9	414.99	46.11	27.31
10	512.33	51.23	30.35
11	619.92	56.36	33.38
12	737.76	61.48	36.42
13	865.84	66.6	39.45
14	1004.17	71.73	42.49
15	1152.74	76.85	45.52
16	1311.56	81.97	48.56

As a mathematical theory, that for trochoidal waves is complete and satisfactory, under the conditions upon which it is based. Sea-water is not a *perfect fluid* such as the theory contemplates; in it there exists a certain amount of viscosity, and the particles must experience resistance in changing their relative positions. There is every reason to believe that the theory closely approximates to the phenomena of deep-sea waves, but it is very desirable that extensive and accurate observations of the dimensions and speeds

of actual waves should be made, in order to test the theory, and determine the closeness of its approximation to truth. The recorded observations on waves are not so complete or numerous as to furnish the test required; and, by adding to them during their service at sea, naval officers will do much to advance one important branch of the science of naval architecture.

Systematic observations of ocean waves scarcely appear to have been attempted until within the last half-century. Amongst the earliest workers in this field were Dr. Scoresby, Mr. Walker, and Commodore Wilkes (United States navy); and of these the first named is justly the best known.* In 1847, Dr. Scoresby made a series of valuable observations on Atlantic storm-waves; and in 1856 he made a still more extensive series of observations during a voyage to Australia *via* the Cape of Good Hope, and a return voyage to England *via* Cape Horn. The records of wave-phenomena, published by Dr. Scoresby, constituted, until recently, the most valuable information on the subject; but in recent years very numerous and trustworthy observations have been made by officers of the Royal Navy, and by officers of the French navy. Of the French observers the most laborious and distinguished was the late Lieutenant Paris, who, during a voyage of more than two years (1867-70), observed and recorded several times each day the state of the sea and the force of the wind. He has been followed by other officers, whose labours have resulted in the accumulation of a mass of facts respecting the lengths, periods, speeds, and heights of ocean waves. Much of this information has been published, and will repay careful study.† No similar publication has appeared of the results of observations of waves made by officers of the Royal Navy during the period above-named; but the regulations issued by the Lords Commissioners of the Admiralty provide for the frequent conduct of such observations, and an analysis of the records ought eventually to yield valuable information.

* For the data obtained by Dr. Scoresby see the *Report* of the British Association for 1850, and his *Journal of a Voyage to Australia*. The results of Mr. Walker's observations will be found in the *Report* of the British Association for 1842; these observations were made at Plymouth. Commodore Wilkes' "Narrative of the United States Exploring Expedition" (1838-42) contains the details of his observations made to the south of Cape Horn.

† Lieutenant Paris' work is recorded

in vol. xxxi. of the *Revue Maritime*, and in a posthumous *Memoir*: Paris, 1885. The most complete summary of the French observations with which we are acquainted is M. Antoine's *Des Lames de Haute Mer* (Paris, 1879). Much interesting information and valuable suggestion is to be found in M. Bertin's essay on the "Experimental Study of Waves," published in the *Transactions* of the Institution of Naval Architects for 1873.

From a scientific point of view, and as a test of the trochoidal theory, the observations made when a ship falls in with a single series of approximately regular waves are most valuable. More frequently observations have to be conducted in a confused sea, successive waves differing from one another in lengths, heights, and periods; and occasional waves occurring of exceptional size as compared with their neighbours. Careful notation of such phenomena would throw light upon the question of the superposition of series of waves, and explain many apparent discrepancies met with in simultaneous observations of waves made by ships sailing in company. It is, however, obviously essential to the value of all these observations that they should be conducted on correct methods, and be accompanied by full records of the attendant circumstances.

Supposing a single series of waves to be encountered, the *lengths* and *periods* of successive waves can be easily determined, if the speed of the ship and her course relatively to the line of advance of the waves are known. The method adopted by Dr. Scoresby and other early observers is still in use, and may be briefly described.*

Two observers (A and B, Fig. 84) are stationed as far apart as

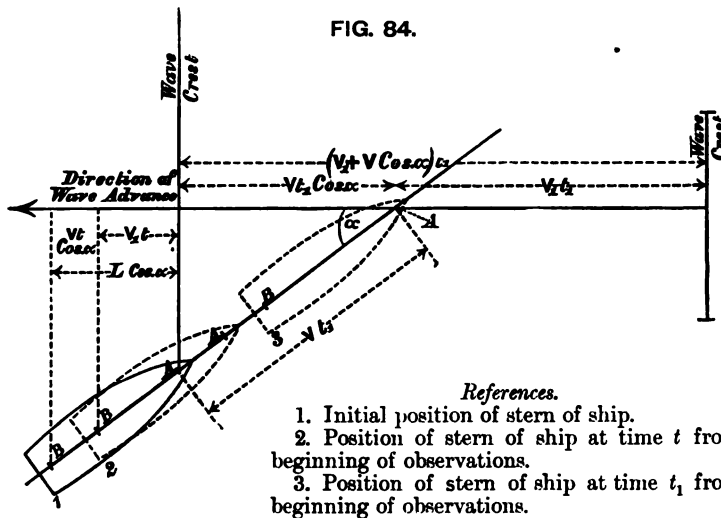

possible, and at a known longitudinal distance from one another. At each station a pair of battens is erected so as to define, when used as sights, a pair of parallel lines at right angles to the ship's

* We here follow very closely the Memorandum prepared by the late Mr. Froude, and approved by the Admiralty for use in the Royal Navy.

keel. The observer at the foremost station notes the instant of time when a wave crest crosses his line of sight; he also notes how long an interval elapses before the next wave crest passes that line. The second observer makes two similar notations for the respective crests. Comparing their records, the observers determine (1) the time (say t , seconds) occupied by the wave crest in passing over the length (L feet) between their stations; (2) the time (say t_1 , seconds) elapsing between the passage of the first and second crest across either line of sights: this time is termed the "apparent period" of the waves. Suppose the ship to be advancing at a speed of V feet per second *towards* the waves, her course making an angle of α degrees with that course which would place her end-on to the waves. Then, expressing the facts algebraically—

$$\text{Apparent speed of wave (feet per second)} = \frac{L}{t}$$

$$\text{Real speed of wave} \quad \quad \quad = V_1 = \left(\frac{L}{t} - V \right) \cos \alpha.$$

$$\text{Real length of wave (feet)} = (V_1 + V \cos \alpha) t_1 = L \cos \alpha \cdot \frac{t_1}{t}$$

$$\text{Period of wave} = \frac{L \cos \alpha}{V_1} \cdot \frac{t_1}{t} = \frac{L \cdot t_1}{L - Vt}$$

If the ship is supposed to be steaming *away* from the waves on the same course at the same speed, all that is necessary is to correct the sign of V in the foregoing equations.

As an example, take the following observations made by Dr. Scoresby during his voyage to Australia, in 1856. The *Royal Charter* was scudding directly before wind and sea, at a speed of 12 knots. An interval of 18 seconds elapsed between the passage of two successive wave crests across the observer's line of sight; and any single wave crest took 9 seconds to traverse a length of 320 feet. Here we have—

$$\alpha = 0; \quad L = 320 \text{ feet}; \quad t_1 = 18 \text{ seconds}; \quad t = 9 \text{ seconds}; \\ V = 20.25 \text{ feet per second.}$$

Substituting in the foregoing equations—

$$\text{Real speed of waves} = V_1 = \left(\frac{320}{9} + 20.25 \right) = 55.8 \text{ ft. per sec.}$$

$$\text{Real length of waves} = 320 \times \frac{18}{9} = 640 \text{ feet.}$$

$$\text{Real period of waves} = \frac{640}{55.8} = 11\frac{1}{2} \text{ seconds (nearly).}$$

From the foregoing remarks it will be obvious that the simplest method of observing the lengths and periods of waves can be applied when a ship is placed end-on to the waves and is stationary. The true period and true speed of the waves can then be obtained by direct observation, and the lengths estimated.

When ships are sailing in company, a good estimate of the lengths of waves may be made by comparing the length of a ship with the distance from crest to crest of successive waves. Care must be taken, of course, to note the angle which the keel of the ship used as a measure of length makes with the line of advance of the waves; otherwise the apparent length of the wave may considerably exceed the true length.

Another method of measuring wave lengths consists in towing a log-line astern of a ship, and noting the length of line when a buoy attached to the after end floats on the wave crest next abaft that on which the stern of the ship momentarily floats. This was the method used by Commodore Wilkes of the United States navy in the observations of waves made by him south of Cape Horn in 1839; it has also been used in the Royal Navy. For its successful application a ship should be placed end-on to the waves, or allowance must be made for the departure of the log-line from that end-on position.

Wave heights are, in most cases, readily measured by the following simple method. When the ship is in the trough of the sea, and for an instant upright, the observer takes up a position such that the successive average wave ridges, as viewed by him from the trough, just reach the line of the horizon without obscuring it. The height of his eye above the water-level correctly measures the height of the wave. In making such observations it is desirable to select a position nearly amidships, so that the influence of pitching and 'scending may be diminished as much as possible. If it becomes necessary to take stations near the bow or stern, allowance must be made, in estimating the height of the eye above water, for the deeper immersion which may be caused at the instant by pitching or 'scending. Due allowance must also be made for changes of level occasioned by rolling or heeling, as well as for the fact that when a ship end-on to the waves is in the middle of the trough the curvature of the wave hollow gives extra immersion to her ends, while the water surface amidships is somewhat below her natural water-line.

This method of estimating wave heights was used by Scoresby, and has been adopted by most of his successors. To measure very high waves the observer may have to ascend the rigging; while for waves of less height a station on one of the decks may suffice, or

some temporary expedient devised for placing an observer near the water-level.

Other methods of measuring wave heights have been proposed, based upon the fact that at a considerable depth below the surface of a disturbed sea, practically still water may be found. Mr. Froude devised one of the best methods of this kind, the apparatus required being very simple and easily managed. It consisted of a light tapered spar of comparatively small diameter, graduated and marked in such a manner as enabled an observer to note with ease the rise and fall of the waves upon it. When in use this pole was "anchored" to the undisturbed water by means of a deep-sea line, to the lower end of which a light frame (see Fig. 85)

FIG. 85.



was attached, this frame carrying a certain amount of ballast. The pole thus weighted stood upright, and performed extremely small vertical oscillations as the waves passed; consequently an observer on board a ship near the pole could note the heights and periods of waves with a close approach to accuracy. This method was applied by Mr. Froude in connection with his experiments with the model of the *Devastation* at Spithead. It is particularly applicable to cases where waves of small height are to be measured, and where horizon observations are not easily made. For general use at sea it is scarcely likely to find favour; nor was it expected to do so by Mr. Froude. Any apparatus of this kind requires that the ship using it must be practically "hove-to" during the time occupied in putting the apparatus overboard, testing its adjustments, making the observations, and afterwards recovering it. On the other hand, horizon observations, when practicable, can be made without interference with the progress of the ship.

Similar objections apply to the automatic "wave-tracer" constructed in 1866 by the late Admiral Paris of the French navy, and tried at Brest with considerable success. The design of this instrument was very simple. A light pole was prepared (similar to that used by Mr. Froude) upon which to measure the rise and fall of the waves. This pole was of considerable length as compared with the heights of the waves to be measured, its cross-section was of small area. It was ballasted with sheet lead in order that it might float upright, with a considerable portion of its length projecting above the surface of still water. No attempt was made to "anchor" the pole to the subjacent undisturbed water, and it consequently performed sensible, but small, vertical oscillations as the waves rose and

fell upon it. On its upper end a float was fitted, this float rising and falling with the waves and sliding up and down the pole. By means of simple mechanism the motions of the float were automatically recorded on a revolving cylinder, and the wave profiles were thus traced.* Waves up to 10 feet in height were thus recorded, and Lieutenant Paris claimed for the instrument a full realization of the hopes of its inventor. He frankly confessed, however, that "a ship not especially detached for the purpose could hardly be expected to arrest her progress several times a day" in order to make use of the wave-tracer. Furthermore, it is evident that in waves of considerable height the instrument could not be used successfully, unless anchored to the undisturbed water lying far below the surface.

The automatic instruments devised by Mr. Froude and M. Bertin for recording the rolling of ships in a seaway, furnish also a means of obtaining valuable information respecting the waves amongst which the ships carrying such instruments may be situated. This will appear from the description given in Chapter VII.

Having briefly described the principal methods of conducting observations on ocean waves, it may be well to summarize the dimensions of the largest waves of which we have any trustworthy accounts. The longest wave observed was measured by Captain Mottez, of the French Navy, in the North Atlantic, and had a length of 2750 feet—half a mile—from crest to crest; its period was 23 seconds. Dr. Scoresby speaks of waves he observed in the Southern Indian Ocean spreading out to "a quarter if not half a mile" in one undulation and crest. In the South Atlantic, Sir James Ross observed a wave 1920 feet long. The largest waves observed in European waters are said to have had a period of $19\frac{3}{4}$ seconds, corresponding to a theoretical length of some 2000 feet; in the Bay of Biscay waves have been noted having a length of 1320 feet. These monster waves are not, however, commonly encountered, and waves having a length of 600 to 700 feet would ordinarily be regarded as large waves. Dr. Scoresby's largest Atlantic storm waves had lengths of about 500 to 600 feet, and periods from 10 to 11 seconds. According to the best authorities, ocean waves of 24 seconds' period, and some 3000 feet in length, may be taken as the extreme limit of size yet proved to exist; waves of 18 seconds' period, and about 1650 feet in length, constitute the upper limit in all except extraordinary cases; and what may be called common large storm waves have periods varying from 6 to 9 seconds, the corresponding lengths varying from 200 to 400 feet.

* See the *Revue Maritime*, vol. xx., and *Transactions* of the Institution of Naval Architects for 1867.

Turning next to measurements of heights in a single series of waves, it appears that waves having a greater height than 30 feet from hollow to crest are not commonly encountered. There are, however, numerous records of heights exceeding 30 feet. Scoresby and others have measured heights of 40 to 45 feet, and there are trustworthy observations of heights of 44 to 48 feet. Commander Kiddle, R.N., claims to have observed waves 1180 feet long and 70 feet high in latitude 48° N., longitude 40° W., during a passage made in January, 1875, from Queenstown to New York, when a heavy and prolonged gale was encountered. From the account given of his method of estimating heights, it appears there were several possible sources of error.* It has been stated also that during a voyage round Cape Horn waves have been measured having heights of 58 to 65 feet, and lengths varying from 750 to 800 feet. This ratio of height to length would seem to indicate that the waves observed were not a single series, but formed by the superposition of two or more series. Under these conditions, or when a great local rise is produced by waves driving against a shore or passing over isolated rocks, heights and steepness may be reached not met with in a single series of waves traversing deep water.

An explanation of the causes of unintentional exaggeration in the estimate of wave heights will at once suggest itself when the variation in the direction of the normal to the wave slope (previously explained) is taken into account. To an observer standing on the deck of a ship which is rolling amongst waves, nothing is more difficult than to determine the true vertical direction, along which the height of the wave must be measured.

If he stands on the raft shown in Fig. 86, he will, like it, be affected by the wave motion; and the *apparent* vertical at any instant will be coincident with the mast

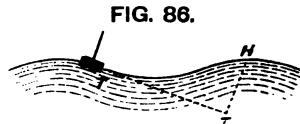

of the raft and normal to the wave slope. He will therefore suppose himself to be looking horizontally when he is really looking along a line parallel to the tangent to the wave slope at that point, which may be considerably inclined to the horizon. Suppose TT, Fig. 86, to represent this line for any position: then the apparent height of the waves to an observer will be HT, which is much greater than the true height. If the observer stands on the deck of a ship,

* For Commander Kiddle's own account see the *Nautical Magazine* for August, 1878. We have to thank him also for drawing attention to the waves

noted off Cape Horn, an account of which appeared in the *Liverpool Mercury* during 1888.

the conditions will be similar; the normal to what is termed the "effective wave slope" (see p. 229) determines the apparent vertical at any instant; and the only easy way of determining the true horizontal direction is by making an observation of the horizon as described above. The extent of the possible error thus introduced will be seen from an example. Take a wave 250 feet long and 13 feet high; its maximum slope to the horizontal is about 9 degrees. Suppose a ship to be at the mid-height between hollow and crest, and the observer to be watching the crest of the next wave; standing about the water level, the wave height will seem to be about 30 feet instead of 13 feet. The steeper the slope of the waves, the greater liability is there to serious errors in estimates of heights, unless proper means are taken to determine the true horizontal and vertical directions. In some cases the apparent height would be about three times the real height.

Next as to the ratio of the heights to the lengths observed in deep-sea waves. All authorities agree that, as the lengths increase, this ratio diminishes, and the wave slope becomes less steep. The shortest waves are the steepest; and the greatest recorded inclinations are for very short waves where the ratio of height to length was about 1 to 6. For a cycloidal wave it will be remembered that the ratio is about 1 to 3.14; so that in the steepest deep-sea waves observed this ratio is only about one-half that of the theoretical limiting case. For waves from 300 to 350 feet in length, the ratio of 1 to 8 has been observed, but these were probably exceptionally steep waves; for waves of 500 to 600 feet in length, it falls to about 1 to 20; and for the longest waves, of uncommon occurrence, it is said to fall so low as 1 to 50. But it is obvious that all measurements of such gigantic waves must be attended with great difficulties, so that the results, even when the greatest care is taken, are only receivable as fair approximations. It seems probable that, in waves of the largest size commonly met, the height does not exceed one-twentieth of the length; and the higher limit of steepness in ocean waves, which are large enough to considerably influence the behaviour of ships, does not give a ratio of height to length exceeding 1 to 10. Long series of observations made in ships of the French Navy show that a common value of the height is about one twenty-fifth—from one-twentieth to one-thirtieth of the length. Waves from 400 to 900 feet in length are sometimes encountered, having heights of from 4 to 10 feet only, and the small ratio of height to length of 1 to 50 has been repeatedly observed in waves from 100 to 400 feet long.

Excluding these exceptionally low ratios of height to length, and taking account of observations where the ratio did not fall below 1 to 40, the following approximate results have been obtained from

an analysis of the published French observations of waves, made in all parts of the world:—

Lengths of waves.	Number of observations.	Length ÷ height.		
		Average.	Maximum.	Minimum.
100 feet and under	11	17	30	5
100 to 200 feet .	55	20	40	9
200 to 300 „ .	44	25	40	10
300 to 400 „ .	36	27	40	17
400 to 500 „ .	17	24	40	15
500 to 650 „ .	16	23	40	17
	179			

This table is worthy of study; although the figures it contains are not exact, and exception may reasonably be taken to the method of averages as applied to these observations. It suggests much as to the comparative frequency with which waves of certain lengths occur, and confirms the opinion that waves become less steep as they increase in length.

The comparison of the relation between the periods and speeds of ocean waves, with the relation which should hold in accordance with the trochoidal theory, has shown a very fair agreement between theory and observation. In not a few cases there are wide divergencies from such agreement; but it is extremely probable that the observations showing these divergencies were made under the conditions of a confused sea, not embraced by the trochoidal formulæ. It is to be observed that in the cases where a single and approximately regular series of waves has been encountered, observation and theory agree most closely. For example, Commodore Wilkes observed to the south of Cape Horn waves having a length of 380 feet, and a period of nearly 8·5 seconds; according to the trochoidal theory, the period should have been about 8·6 seconds. Again, Dr. Scoresby observed Atlantic storm waves having lengths of 560 to 600 feet, and periods of about $11\frac{2}{3}$ seconds; the period, according to the trochoidal theory, for a wave 580 feet long, would be about 10·6 seconds. On his voyage to Australia, Scoresby noted waves 640 feet long and $11\frac{1}{2}$ seconds period; the theoretical period for waves of this length would be a little over 11 seconds. Lieutenant Paris, also, in the Southern Indian Ocean measured waves from 300 to 400 metres long, and having a speed of 19 metres per second; their period, according to this data, must have been about

18 seconds, and, according to theory, it would have been about 15 seconds. On another occasion the same observer noted waves 180 metres long, and $10\frac{1}{2}$ seconds period; according to theory the period would have been about $10\frac{1}{4}$ seconds. A few observations of waves made in the Pacific on board one of her Majesty's ships gave periods for waves from 180 to 320 feet long agreeing almost exactly with the theoretical periods.

During the voyage of the *Challenger* the dimensions of waves were observed at times. On one occasion she was running before a north-west gale fairly steady in strength, the wind having a speed of 30 miles an hour. The waves were found to have lengths of 420 to 480 feet, heights of 18 to 22 feet, and speeds of about 29.5 knots per hour, or 50 feet per second. Taking 450 feet as the mean length of the waves, their average period was 9 seconds; the theoretical period for that length being about 9.36 seconds, which indicates a very close approximation between observation and theory.*

Passing from these special test cases to the ordinary cases where waves are less regular and uniform in character, it may be well to give a few examples of the comparison between observed and theoretical lengths of waves. The first table is based upon the results of French observations, exceeding 200 in number, made by different observers on various stations.

LENGTHS OF OCEAN WAVES (IN METRES).

Observed.	Calculated.	Observed.	Calculated.	Observed.	Calculated.
30	30	80	85	143	131
30	42	80	95	148	161
35	42	85	60	150	134
42	42	90	100	153	175
50	60	95	95	160	156
56	60	100	67	165	161
60	52	100	108	170	171
60	67	105	116	170	144
65	52	114	124	172	175
65	73	120	112	180	108
70	67	120	120	180	147
70	74	130	164	180	185
75	60	135	134	190	200
79	80				

Note.—A metre is 3.281 feet.

The second table is based upon observations made on board some of her Majesty's ships.

* See p. 330, vol. i., of "Voyage of the *Challenger*," for details of methods of observation.

LENGTHS OF OCEAN WAVES (IN FEET).

Observed.	Calculated.	Observed.	Calculated.	Observed.	Calculated.
80	82	220	184	375	330
160	128	245	250	400	370
160	184	250	250	420	510
180	185	300	250	500	420
200	184	300	328	530	440
200	250	350	328	630	520

On a review of a large number of observations it appears that the observed lengths are, on an average, rather less than the theoretical lengths; but it must be admitted that here also the method of averages is not trustworthy, especially when it is known that in some instances errors of considerable proportionate magnitude exist in the individual observations. These errors arise from various causes, one of the most common being the failure to distinguish correctly the difference between the real and the apparent speeds and dimensions of waves. In addition there are the special difficulties frequently encountered when the waves to be measured are the result of the superposition of two or more series of waves, each moving at its own speed, and possibly in different directions. In such a confused sea there is an entire want of regularity or uniformity in successive waves which pass an observer on board a ship, and the best course he can pursue is to note the particulars for a considerable number of waves in order that something like mean results may be obtained. For example, in making a set of observations on board one of her Majesty's ships, when the sea was formed by two series of waves running at different speeds in nearly the same direction, the following results were noted. First, the intervals which ten successive wave crests occupied in passing over a certain length were respectively 6, 7, 4, 6, 6, 3, 6, 5, 7, and $6\frac{1}{2}$ seconds; the mean being about 5.6 seconds. Second, the apparent lengths varied from 250 to 420 feet. These apparent variations admit of easy explanation, and for this purpose we will take the simple case illustrated by Figs. 87-92. Fig. 87 shows a wave 400 feet long and 20 feet high, having a speed of about 45 feet per second; Fig. 88, a wave 200 feet long and 12 feet high, having a speed of about 32 feet per second. The straight lines in both figures indicate the level of still water. In Fig. 89 the shorter wave is superposed upon the longer, the latter being shown by a dotted line; the two crests coincide, and the resultant wave has a height from hollow to crest of about 26 feet, while the length from hollow to hollow is about 300 feet. The long wave form gains about 13 feet per second on the shorter wave. In $2\frac{1}{2}$ seconds the profile

of the combined wave will have changed from the condition of Fig. 89 to that of Fig. 90; the heights of successive crests being about 30 feet and 5 feet, and the length between these crests being about 200 feet. In less than 4 seconds the further change shown in Fig.

FIG. 87.

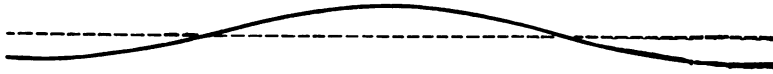

FIG. 88.

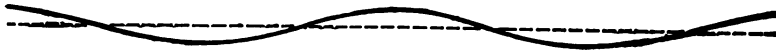

FIG. 89.

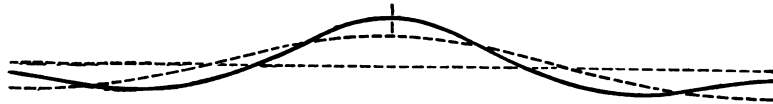

FIG. 90.

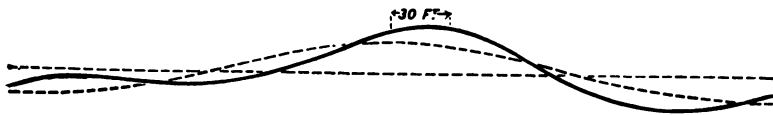

FIG. 91.

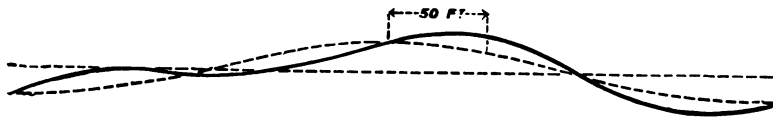
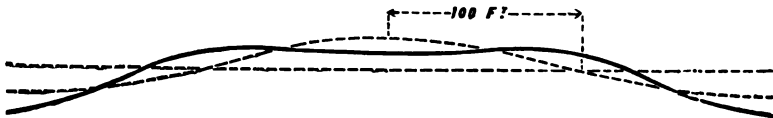

FIG. 92.



91 will have occurred, and in less than 8 seconds the condition shown in Fig. 92 will have been reached, a wave hollow appearing where the crest of the 400-foot wave is placed. In this last condition the height from this hollow to the adjacent crests is only about 3 feet, and the crests are 160 feet apart. In fact there occurs a long

“smooth” in the series, but the next wave series would have heights of about 25 feet. This illustration shows how difficult the task of making observations of waves may become in a confused seaway formed by the superposition of several series of waves moving in different directions. Here too we find a satisfactory explanation of the differences sometimes noted in the simultaneous observations of waves by ships sailing in company. For example, one ship of a squadron reported the waves to be 450 feet long, whereas a second ship put the length at 150 feet. The observer may, it is true, sometimes succeed in distinguishing the principal members of the waves in one or more of the superposed series; but this involves a long continuance of the observations, and is rarely to be accomplished with certainty. In making such observations in a confused sea the fullest particulars should be recorded, for without a knowledge of the attendant circumstances no possible use can be made of the results. For this reason, also, it is very desirable that any comparisons between the results of theory and observation should be made by the observers at, or soon after, the time the observations are in progress, since no other person can have an equally good knowledge of the particular circumstances of each case.

No theory has yet been accepted which fully accounts for the genesis of waves; the trochoidal theory merely deals with waves already created, and maintaining unaltered forms and velocities. There can, of course, be no question but that waves result from the action of the wind on the sea, and that there must be some connection between the character and the force of the wind and the dimensions and periods of the waves. But as yet we have not sufficient knowledge to determine either the mode of action of the wind or the law connecting its force with the dimensions of waves. Here again is a field where careful and extensive observations can alone be relied upon; pure theory would be useless.

In the preceding pages it has been shown that, with care, the lengths, heights, and periods of waves may be determined very closely when the sea is not confused; and it is also possible, with care, to ascertain simultaneously the force or speed of the wind. But it is to be noted that the rapidity with which waves travel, and the fact that they maintain their lengths and speeds almost unchanged even when the force of the wind decreases and the wave height becomes less, make it necessary to exercise great caution in associating any observed force of wind with the lengths and periods of waves observed simultaneously. The importance of this matter justifies further illustration.

If the wind is at first supposed to act on a smooth sea, and then

to continue to blow with steady force and in one direction, it will create waves which finally will attain certain definite dimensions. The phases of change from the smooth sea to the fully formed waves cannot be distinctly traced. It is, however, probable that changes of level, elevations and depressions, resulting from the impact of the wind on the surface of the sea, and the frictional resistance of the wind on the water are the chief causes of the growth of waves. An elevation and its corresponding depression once formed offer direct resistance to the action of the wind, and its unbalanced pressure producing motion in the heaped-up water would ultimately lead to the creation of larger and larger waves. This is probably the chief cause of wave-growth, frictional resistance playing a very subordinate part as compared with it. So long as the speed of the wind relatively to that of the wave water is capable of accelerating its motion, so long may we expect the speed of the wave to increase, and with the speed the length, and also the height. Finally, the waves reach such a speed that the wind force produces no further acceleration, and only just maintains the form unchanged, then we have the fully grown waves. If the wind were now suddenly withdrawn, the waves would gradually decrease in magnitude and finally die out. This degradation results from the resistance due to the molecular forces in the wave—viscosity of the water, etc.—and when the waves are fully grown, the wind must at every instant balance the molecular forces. If the water were a perfect fluid (the particles moving freely past one another), and if there were no resistance to motion on the part of the air, the waves once formed would travel onwards without degradation. But in sea-water the degradation takes place at a rate dependent upon the ratio of the resistance of the molecular forces to the “energy” of the wave.* At each instant the resistance abstracts a certain amount from the energy of the wave, and consequently the height decreases. The period and length of the wave might remain almost unchanged, and, it would seem from observation, really do so for a considerable time, while the height decreases; just as it has been shown that in a ship oscillating in still water the resistance gradually diminishes the range of oscillation without decreasing the period sensibly. As examples of this maintenance of length while height is degraded, reference may be made to a long swell observed by the Channel Squadron in 1893, after severe storms in the North-Western Atlantic.

* In wave motion the “energy” is half “actual” and half “potential.” By “actual” energy is meant that due to the motions of the particles in a wave; by “potential” energy is meant

the work done in raising the centre of gravity of its mass a certain distance above the position which it would occupy in still water. See remarks as to this rise on p. 199.

Careful measurements showed lengths of 450 to 520 feet to be associated with heights of 10 to 12 feet, the corresponding heights for fully grown waves of this length and period being about 20 to 25 feet.

Between this condition of fully grown waves and the case of waves gradually dying out in a dead calm lies that which commonly occurs where the waves are gradually dying out, but the wind still has a certain force and speed. Then an observer, noting the dimensions of the waves and force of the wind simultaneously, might record lengths and periods corresponding, not to the observed force of wind, but to the force which existed when the waves were of their full size. On the other hand, there would, in all probability, be a correspondence between the observed force of wind and the observed heights, and an analysis of the recorded observations made by officers of the French Navy confirms this view. Nothing but the closest attention on the part of an observer can enable him to make his records a trustworthy basis for theory; for it is in his power alone, having regard to all the circumstances of the observations, to say whether, when observed, the waves are fully grown, and correspond to the observed force of wind, or whether they are in process of growth or of degradation. A series of observations might settle this matter, if made in a careful and intelligent manner, the growth or degradation being indicated by the alterations in heights of waves noted after certain intervals from the first observations.

Perhaps the most favourable time for observations to be begun would be that when on a nearly calm sea a storm breaks, forming waves of which the dimensions gradually increase, but the opportunities are not likely to be numerous where the waves so formed constitute an independent regular series. Usually the observer would probably find himself in face of a confused sea, when the wave genesis is in its earlier stages; but if he could note the times occupied by waves in attaining their full growth under the action of winds of various speeds, he would do good service. Any pre-existing swell must be allowed for in making these observations; otherwise the assumption that the waves are formed from smooth water would be departed from.

In concluding these remarks on wave genesis, M. Bertin's essay on the subject may be quoted. He says: "The study of the time necessary for each swell to retain its fixed and permanent condition under the action of the wind which produces it is very interesting. If the time be so long as in general to exceed that during which the wind can remain pretty nearly constant, both in intensity and direction, all interest in the connection between the wind and the

“swell would disappear. The length of waves and their inclination for a given length would be just as irregular as meteorological variations. If, on the contrary, the waves soon reach their regular condition—a fact which seems to be pretty well established, inasmuch as those seas which are exposed to the action of constant winds present no extraordinary agitation—one is necessarily driven to adopt the law that for each length of waves there is a certain height that is most commonly met with, and that cannot be exceeded.”

Passing from these general considerations, it may be interesting to refer to the attempts made by French investigators to formulate expressions connecting the dimensions of waves with the force or speed of winds. Admiral Coupvent Desbois laid down a provisional theory, based upon ten thousand actual observations, that the cube of the height of the waves is proportional to the square of the speed of the wind.* Lieutenant Paris suggested, from an analysis of his own observations, that the speed of waves is proportional to the square root of the speed of the wind; but he was of opinion that much more extensive observations were needed before any law could be accepted. Lieutenant Paris' formula may be expressed as follows, reckoning speeds in metres per second:—

$$\text{Speed of wind} = \cdot 073 (\text{speed of wave})^2.$$

Converting this into English measures, and reckoning speeds in feet per second, we have—

$$\text{Speed of wind} = \cdot 022 (\text{speed of wave})^2.$$

Whence, making use of the formula connecting the speeds and lengths of waves, it follows that—

$$\text{Speed of wind} = \cdot 115 \text{ length of wave.}$$

When the sea was heavy Lieutenant Paris always found the speed of the wind exceed that of the wave form; but in moderate seas having a speed of 36 feet per second, or less, he frequently recorded speeds of wind which were less than the speeds of the waves formed by the action of that force of wind. The following table contains a few illustrations of this noteworthy feature in these admirable records:—

* See the *Comptes-rendus de l'Académie des Sciences* of 1866.

Locality.	Mean heights of waves.	Mean speeds.*	
		Wind.	Wave.
	metres.		
Atlantic (region of trade winds)	1·9	4·8	11·2
South Atlantic	4·3	13·5	14·0
Indian Ocean (south of)	5·3	17·4	15·0
Indian Ocean (region of trade winds)	2·8	6·5	12·6
Seas of China and Japan	3·2	14·6	11·4
West Pacific	3·1	8·5	12·4

In the present state of knowledge, we are not able to say that there is anything impossible in the observation of waves moving faster than the winds, which have a force corresponding to their full growth, although this condition would scarcely be anticipated. Remembering what was said above as to the difference between the rates of the actual orbital motions of particles in their circular paths and the apparent speed of advance of the wave form, it will be clear that, even when the wave form advances faster than the wind travels, the wind may be moving much faster than the particles in the wave. Take, for example, the waves of the Southern Indian Ocean. M. Paris gives them a mean height of 5·3 metres, and a mean period of 7·6 seconds.

Diameter of orbits of surface particles = 5·3 metres.

Circumference of orbits of surface particles = 16·6 metres.

Orbital velocity of particles = $\frac{16·6}{7·6} = 2\frac{1}{4}$ metres per second.

Velocity of wind observed = 17·4 metres per second.

Whether the relative velocity of the wind and the wave form should be taken as the measure of the full effect of the wind, or whether the relative velocity of the wind and the particles of water in the wave does not also exercise considerable influence, must for the present, at least, be considered a matter open to debate. In the maintenance of the wave speed as the wind speed slackens, we have a possible explanation of the apparent anomaly in the above table; and, further, it is difficult for an observer on board a ship in motion to measure the speed of the wind accurately. But actual observations, such as have been recommended in this chapter, will settle this and many other doubtful points.

M. Antoine, of the French Navy, has also endeavoured to frame formulæ connecting the dimensions and speeds of ocean waves with

* In metres per second; a metre is 3·281 feet.

the speeds of wind ; and for this purpose has made a very lengthy analysis of the returns furnished by French war-ships.*

Taking 130 observations made in vessels of the French Navy, M. Antoine classified them as follows in his Memoir of 1876 :—

Speed of wind.	Number of observation per series.	Waves.			
		Mean lengths.		Mean heights.	
		Observed.	Calculated by approximate formula.	Observed.	Calculated by approximate formula.
Metres per second.		metres.	metres.	metres.	metres.
1·5	12	54·6	36·0	1·7	1·0
4·0	16	63·7	60·0	2·4	1·9
7·0	18	87·9	79·5	3·2	2·7
11·0	29	79·7	99·6	4·0	3·7
16·0	22	100·0	120·0	5·4	4·8
22·0	19	90·0	141·0	5·1	5·9
29·0	11	131·0	161·0	7·7	7·1
37·0	3	180·0	182·0	8·5	8·3

It will be observed that the calculated heights agree very closely with the observed heights ; whereas there are very considerable differences between the calculated and the observed lengths. This is a suggestive contrast, as will appear more clearly in reference to the remarks made above.

In obtaining the approximate formulæ for lengths and heights of waves, M. Antoine used the following notation :—

Let V = speed of waves (in metres per second).

v = " wind " "

2L = length of waves (in metres).

2T = period " (in seconds).

2H = height " (in metres).

Then, assuming Admiral Couvent Desbois' law to hold, the following are considered to be good approximations :—

$$2H = 0\cdot75 \times v^{\frac{2}{3}} \quad . \quad . \quad . \quad (1)$$

$$2L = 30v^{\frac{1}{2}} \quad . \quad . \quad . \quad (2)$$

$$2T = 4\cdot4v^{\frac{1}{4}} \quad . \quad . \quad . \quad (3)$$

$$V = 6\cdot9v^{\frac{1}{4}} \quad . \quad . \quad . \quad (4)$$

* See *Notes complémentaires sur les Lames de haute mer*, 1876 ; also *Des Lames de haute mer* (Paris, 1879).

The "constants" in equations (1) and (4), M. Antoine derives from an analysis of numerous observations; those in equations (2) and (3) are derived from (4) by means of the theoretical formula given on p. 204.

In his later publication, M. Antoine somewhat varied his procedure, and attempted to investigate whether "in the deformation of a wave the product of the length by the height would not remain practically constant for waves created by the action of a wind of a given force, the value of this product being termed the *modulus of the wave*." He retained the fundamental formulæ given above, and as the result of his analysis of over 200 observations formed the following table:—

MODULI OF WAVES (PRODUCT OF HEIGHT BY LENGTH).

Speed of wind.	Moduli.	
Metres per second.	Calculated.	Observed.
0 to 2	0 to 51	80
3 to 5	78 to 148	170
6 to 8	184 to 255	362
9 to 13	297 to 443	379
14 to 18	493 to 648	595
19 to 25	685 to 960	650
26 to 32	1010 to 1283	1070
33 to 42	1332 to 1765	1516

M. Antoine added, "According to the preceding formulæ, the modulus of a wave should be proportional to the expression—

$$(\text{Speed of wind})^{\frac{1}{2}};$$

"I reserve to myself the investigation, when more numerous observations have been made, of the problem whether one might not suppose the modulus to be proportional simply to the speed of the wind, which would make the length of a regular wave proportional to the square root of the height."

Attention has been drawn to the preceding attempts to connect wave phenomena and wind forces with the hope that the subject will be treated also by English observers with the consideration it undoubtedly deserves. The problem still awaits solution, for the formulæ given above are based upon reasoning to which grave objections may be taken, although they cannot be stated here.

Lieutenant Paris attempted to ascertain what were the prevalent waves most likely to be encountered in particular localities. The following table prepared by him, gives the result of observations extending over more than two years. It is a notable effort to describe the mean condition of the sea, and well worthy of the attention of

naval officers, who would render good service to science by endeavouring to extend the investigation.

Locality.	Mean period.
	seconds.
Atlantic (the Trades)	5·8
South Atlantic (region of the westerly winds)	9·5
Indian Ocean, South (region of the easterly winds)	7·6
Indian Ocean (trade winds)	7·6
China Seas	6·9
West Pacific	8·2

In concluding this chapter, brief reference must be made to the attempts to obtain motive power for propulsion or other purposes from the motions impressed upon a ship by the wave motion. Mr. Spencer Deverell, of Victoria, was the first to draw attention to the subject; and his brother conducted a series of observations in 1873 during a voyage from Melbourne to London, for the purpose of proving that during an ocean voyage a ship will be continually oscillating—rolling, pitching, and heaving—even when there is a dead calm. Limits of space prevent any extracts being given from the interesting records of these observations, which will well repay perusal; nor can any account be given of the apparatus proposed for the purpose of obtaining motive power from the wave-motion.* The principle of all the proposals may be simply explained. In a seaway the heaving and other motions impressed upon a ship cause variations in her virtual weight (as explained at p. 203). If a weight inboard is suspended by a spring balance, the latter will indicate less than the true weight on the wave crest, and more than the true weight in the wave hollow. The *extensions of the spring* will vary according to the virtual weight, being greatest at the wave hollow, and least at the crest. By some appropriate mechanism these varying extensions of the spring are made to produce rotary or other motions. Numerous experiments have been made with models, but hitherto no practical use seems to have been made of the principle.

* See papers on "Ocean Wave Power and its Utilization," in the *Transactions* of the Royal Society of Victoria for 1873; and "The Continuous Oscillation of a Ship during an Ocean Voyage," in the *Transactions* of the Institution of Naval Architects for 1874, by Mr. Spencer Deverell; also a paper by Mr. Tower in the *Transactions* of the Institution of Naval Architects for 1875.



CHAPTER VI.

THE OSCILLATIONS OF SHIPS AMONG WAVES.

IN the two preceding chapters we have discussed the condition of a ship oscillating in still water, and the phenomena of wave motion in the deep sea, subjects which have an interest in themselves, but derive their greatest importance from their connection with the subject now claiming attention. The motions of a ship in a seaway are influenced by her stability, her inertia, by the variations in direction and magnitude of the fluid pressure incidental to wave motion, and by the fluid resistance; so that, without clear and correct conceptions of each of these features in the problem, it would be impossible to deal with their combined effect.

The oscillations of a ship in a seaway, like those in still water, may be considered as resolvable into two principal sets: first, the transverse oscillations of rolling; second, the longitudinal oscillations of pitching and 'scending. Transverse oscillations, having by far the most important bearing upon the safety and good behaviour of ships, will receive the greatest attention. Pitching and 'scending may become violent and objectionable in some ships, but this is not commonly the case, nor is it so difficult of correction as heavy rolling. Only a brief discussion of these longitudinal oscillations will therefore be necessary, and it will follow the remarks on rolling.

Very various causes have been assigned for the rolling motion of a ship at sea. Some of the earlier writers, impressed by the great speed of advance of waves, attributed rolling to the shocks of waves against the sides of ships. Others considered motion as originated by the slope of the wave surface; observing that, if a ship remained upright on the wave slope, her displacement would change its form from that in still water, the centre of buoyancy moving out from below the centre of gravity towards the wave crest, and the moment of stability thus produced tending to make the vessel heel away from the wave crest. There were obvious objections to both these theories. It is a matter of common experience that vessels often roll very heavily in a long smooth swell, where the slope is so small that the



departure from the horizontal is scarcely perceptible, and where no sensible shock is delivered against the sides of the ships. The best of the earlier theories, put forward by Daniel Bernoulli about a century ago, departed from the preceding theories, and was content to speak of the oscillations of a ship as comparable to those of a pendulum, subjected to the action of "impulses" from the waves, no analysis being attempted of the character or causes of these impulses. Some of the conclusions which Bernoulli reached even now command respect; but he, in common with his contemporaries, failed to realize or to express the fundamental condition wherein wave water differs from still water, viz. that the direction and intensity of the fluid pressure are continually varying instead of being constant, as in still water. For nearly a century the subject remained very nearly in the condition in which Bernoulli, Euler, and other writers of that period had left it, until the late Mr. W. Froude introduced the now accepted theory of rolling. This theory rests upon the fundamental doctrine, explained in the previous chapter, that in wave water the direction of the pressure at any point is a normal to the trochoidal surface of equal pressure passing through that point; and in that particular the modern theory differs from all that preceded it. It is not put forward as a perfect theory, fully expressing all the conditions of the problem; but it far more completely represents those conditions than any theory which preceded it, and has exercised a great and beneficial effect upon ship designs. Moreover, in its main features, it has secured the adhesion of the greatest authorities on the science of naval architecture, both English and foreign, some of whom have very considerably helped its extension. An attempt to describe in popular language the main features of the theory cannot, therefore, be devoid of interest, even though the avoidance of mathematical language may render the description which follows incomplete.

At the outset it may be well to state that the modern theory of rolling finds the governing conditions of the behaviour of a ship among waves to be twofold:—

(1) The ratio which the period of still-water oscillations of the ship (or "natural period") bears to the period of the waves amongst which she is rolling.

(2) The magnitude of the effect of fluid resistance.

Both the natural period and the means of estimating the magnitude of the fluid resistance for any ship may be obtained from experiments made in still water, as previously explained.

It will be convenient to deal separately with these conditions, first illustrating the causes which make the ratio of the periods so important, and in doing so leaving resistance out of account; afterwards illustrating the effect of resistance in limiting the range of

oscillation. In practice the two conditions, of course, act concurrently; but the hypothetical separation here made will probably enable each to be better understood.

Reverting to the case illustrated by Fig. 82, p. 201, where a small raft floats upon the inclined surface (AB) of the water in a vessel which is moving horizontally, it will be noticed that the raft is acted upon by the following fluid pressures: P, acting downwards on the upper side; an equal pressure, P, acting upwards on the lower side; and the buoyancy b acting normally to the surface AB through the centre of buoyancy of the raft. Let w be the weight of the raft acting vertically downwards through the centre of gravity when in still water. When the vessel containing the water is in motion, this weight w must be combined with the horizontal accelerating force due to the motion, in the manner explained on p. 201. Using the same notation as before, we have—

Resultant of weight and horizontal accelerating force = $w \sec \alpha$.

This resultant will act perpendicularly to the inclined water surface, just as the buoyancy b does; and for equilibrium we must have—

$$b = w \sec \alpha,$$

and the line of action of b must pass through the centre of gravity of the raft. Hence it follows that the normal to the free water surface indicates the direction towards which the raft will tend to return if her mast is inclined from it; just as in still water the upright is her position of equilibrium. The normal to the water surface may therefore be termed the "virtual upright" for the raft when it and the water are subjected to horizontal acceleration; since the normal fixes the position of equilibrium.

Next suppose this very small raft to float on the surface of a wave, as in Fig. 83, p. 202. Here reasoning similar to the foregoing applies, if the raft be considered so small in relation to the wave that it may be treated as if it replaced a particle, and moved just as the particle would have done. In the preceding chapter it has been shown that at any point in a trochoidal wave the normal represents the direction of fluid pressure at that point, and it has also been stated that this direction changes from point to point along the wave surface, the variations in inclination resembling the oscillation of a pendulum having a period for a single swing equal to half the wave period. The cases of Figs. 82 and 83 therefore differ in this: in the former, where the water surface has a constant inclination, the "virtual upright" also has a constant direction; whereas on the wave the "virtual upright," or position of equilibrium, in which the masts of the raft will lie, varies in direction from instant to instant, the varia-

tions being dependent upon the wave slope and wave period. On the wave the raft is also subjected to vertical as well as horizontal accelerations, affecting both the value of the fluid pressure upon its bottom and its own apparent weight, but affecting both equally, and therefore not changing the volume of displacement of the raft from that in still water. The law of this variation in the pressure and apparent weight has been given in the preceding chapter, and illustrated by Fig. 81, but for our present purpose the variation in the direction of the pressure is of greater importance.

A ship differs from this hypothetical raft, having lateral and vertical extension in the wave, as shown by ADC in Fig. 83. Even though she may be small when compared with the wave, it is obvious that she cannot be treated as a single particle replacing a particle in the wave. At any moment she displaces a number of particles which, were she absent, would be moving in orbits of different radii, and at different speeds. Her presence must therefore introduce a disturbance of the internal motions in the wave, and this disturbance must in some manner react upon the ship and somewhat influence her behaviour. Our present knowledge of the conditions governing the internal molecular forces in the waves of the sea is not sufficient to enable exact mathematical treatment to be applied in estimating the effect of this disturbance, and determining at each instant the position of the "virtual upright" for the ship. If the positions of the virtual upright were known, each of them would be a normal to a surface termed "the effective wave slope." Conversely, the effective wave slope may be defined as the surface, the normal to which at any point represents the instantaneous position of equilibrium for the masts of the ship.

Although our knowledge of the subject does not enable the form of the effective wave slope to be accurately determined, certain considerations of a general character must influence that form. For example, the size of the ship relatively to the waves, the form of her immersed part, its lateral extension along, and vertical extension into, the waves, as well as the vertical position of her centre of gravity, are all known to affect the effective wave slope. Moreover, that slope may differ considerably from the upper surface of the waves. Large ships, for instance, when floating among very small waves, even with their broadsides to the line of the wave advance, may be supported simultaneously by the slopes of successive waves, and these slopes being inclined in opposite directions, the effective slope may be practically horizontal. Again, ships of very great breadth, such as the *Livadia*, or the circular ironclads, when floating broadside on to the waves, occupy so great an extent of the slope of one of the largest ocean waves, that the effective slope can only

have a very moderate amount of steepness as compared with the maximum slope of the wave surface. In the extreme case of a ship of narrow beam but great draught of water, the effective slope obviously would have its steepness decreased in virtue of the fact that trochoidal subsurfaces in a wave are flatter than the upper surface.

All these illustrations serve to show that the determination of the effective wave slope for a particular case can only be made approximately. For the purpose of mathematical investigation of the hypothetical case of, unresisted rolling it is, however, usual to assume that a ship falls in with waves so large relatively to her own dimensions that she accompanies their motion. Starting with this assumption of the relative smallness of a ship, it has sometimes been assumed that the effective slope will nearly coincide with the trochoidal subsurface passing through the centre of buoyancy of the ship. In Fig. 83, let B represent the centre of buoyancy of the ship shown in section by ACD; then TT_1 , the subsurface of equal pressure passing through B, would be termed the effective wave slope, and the normal to it, NN_1 , would be taken as determining the instantaneous position of equilibrium for the ship. In the diagram the ship is shown purposely with her middle line (GM) not coincident with the normal NN_1 ; M, the point of intersection of these lines, may be regarded as the metacentre for small transverse inclinations of the ship from the virtual upright; the angle BMN_1 measures the inclination of the ship from the instantaneous position of equilibrium. Through the centre of gravity G, GZ is drawn perpendicularly to NN_1 ; then instantaneously the effort of stability, or righting moment, with which the ship tends to move towards the position NN_1 , is measured by the expression—

$$\text{Righting moment} = \text{apparent weight} \times GZ.$$

In estimating the apparent weight of the ship, which is practically equal to, and has a line of action parallel to, the fluid pressure acting along NN_1 , it is of course necessary to take account of the radii of the particles situated in the subsurface TT_1 . Very often the actual weight may be substituted for the apparent weight without any great error; but this is a matter easily investigated, in accordance with the principles previously explained.

This method of approximating to the effective slope, although widely adopted, is not universally accepted, nor does it profess to be more than an average or approximation under the assumption of the relative smallness of a ship as compared with the waves. In some cases the effective slope lies nearer the upper surface than TT_1 would be situated. Cases may be conceived also where the effective slope

is steeper than the upper surface. Amongst relatively large waves the effective slope is usually less steep than the upper surface—a fact which is confirmed by the careful and extensive observations made by Mr. Froude on board the *Devastation*. In practice, therefore, it is an error on the side of safety to assume, as is not unfrequently done, that the variations in inclination and magnitude of the fluid pressure and the apparent weight of the ship, may be determined from the upper surface of the wave. This was the plan adopted by Mr. Froude in his earliest investigations, as well as that followed by the Admiralty Committee of 1871 on Designs for Ships of War, in their estimate of the probable limits of rolling of the *Devastation* class. It will be seen that this substitution of the upper surface for the less steep effective surface in no way affects the period occupied by the wave normal in performing the set of motions from upright at the hollow onward to upright at the crest of a wave. The difference is solely one of the maximum inclination to the vertical reached by the wave normal, and taking the upper surface usually somewhat increases this beyond the true maximum in the critical cases with which the mathematical theory deals.

Suppose a ship lying broadside-on to the waves to be upright and at rest when the first wave hollow reaches her; at that instant the normal to the surface coincides with the vertical, and there is no tendency to disturb the ship. But a moment later, as the wave form passes on and brings the slope under the ship, the virtual upright towards which she tends to move, becomes inclined to the vertical. This inclination at once develops a righting moment tending to bring the masts of the ship into coincidence with the instantaneous position of the normal to the wave. Hence rolling motion begins, and the ship moves initially at a rate dependent upon her still-water period of oscillation. Simultaneously with her motion, the wave normal is shifting its direction at every instant, becoming more and more inclined to the vertical, until near the mid-height of the wave it reaches its maximum inclination, after which it gradually returns towards the upright; the rate of this motion is dependent upon the period of the wave. Whether the vessel will move quickly enough to overtake the normal or not, depends upon the ratio of her still-water period to the interval occupied by the normal in reaching its maximum inclination and returning to the upright again, which it accomplishes at the wave crest; this interval equals *one-half* the period of the wave. Hence it appears that the ratio of the period of the ship (for a single roll) to the half-period of the wave must influence her rolling very considerably, even during the passage of a single wave, and still more is this true when a long series of waves

move past the ship, as will be shown hereafter.* It will also be obvious that the chief cause of the rolling of ships amongst waves is to be found in the constant changes in the direction of the fluid-pressure accompanying wave motion.

As simple illustrations of the foregoing remarks, two extreme cases may be taken. The first is that of a little raft, like that in Fig. 83, having a natural period indefinitely small as compared with the half-period of the wave. Her motions will consequently be so quick as compared with those of the wave normal, that she will be able continuously to keep her mast almost coincident with the normal and her deck parallel to the wave slope. Being upright at the wave hollow, she will have attained one extreme of roll about the mid-height of the wave, and be again upright at the crest. The period of this single roll will be half the wave period. As successive waves in the series pass under the raft, she will acquire no greater motion, but continue oscillating through a fixed arc and with unaltered period. The arc of oscillation will be double the maximum angle of wave slope.

The other extreme case is that of a very small vessel having a natural period of oscillation, which is very long when compared with the wave period. For instance, a small cylinder like that in Fig. 69, p. 152, may be so weighted that the centre of gravity may approach closely to the height of the axis, but remain below it; then, as explained previously, there will be stable equilibrium, and a very long period of oscillation may be secured by disposing the weights towards the circumference of the circular cross-sections. If such a vessel were upright and at rest in the wave hollow, she would be subjected to rolling tendencies similar to those of the raft, owing to the successive inclinations of the wave normal—her instantaneous virtual upright. But her long period would make her motion so slow as compared with that of the wave normal that, instead of keeping pace with the latter, the ship would be left far behind. In fact, the half-wave period during which the normal completes an oscillation would be so short relatively to the period of the ship that, before she could have moved far, the wave normal would have passed through the maximum inclination—it attains near the mid-height of the wave, and rather more than halfway between

* It has already been explained that we follow the Admiralty method in terming a single roll "an oscillation," and the time occupied in its performance the "period of oscillation." Mathematicians commonly apply the term "oscillation" to a double roll, and the term "period" to the time occupied in performing the double roll. We again refer to the matter, as in many published papers the mathematical terms are employed.

hollow and crest. From that point onwards to the crest it would be moving back towards the upright; and the effort of the ship to move towards it, and further away from the upright, would in consequence be diminished continuously. At the crest the normal is upright, and the vessel but little inclined—inclined, it will be observed, in such a sense that the variations in direction of the normal, on the second or back slope of the wave, will tend to restore her to the upright. Hence it follows that the passage of a wave under such a ship disturbs her but little, her deck remains nearly horizontal, and she is a much steadier gun-platform than the raft-like vessel.

No ship actually fulfils the conditions of either of these extreme cases, nor can her rolling be unresisted as is here assumed. Experience proves, however, that vessels having very short periods of oscillation in still water tend to acquire a fixed range of oscillation when they encounter large ocean waves, keeping their decks approximately parallel to the effective wave slopes. Actual observations also show that vessels having the longest periods of oscillation in still water are, as a rule, the steadiest amongst waves, keeping their decks approximately horizontal, and rolling through small arcs. Hereafter, the details of some of these observations of the behaviour of actual ships will be given; but attention must be confined, at present, to the general hypothesis of unresisted rolling among waves. Having cleared the way by the foregoing illustrations, we shall now attempt a general sketch of the modern method of investigation.

The following assumptions are made in order to bring the problem of the motion of a ship in a seaway within the scope of exact mathematical treatment:—

(1) The ship is regarded as lying broadside-on to the waves with no sail set, and without any motion of progression in the direction of the wave advance; in other words, she is supposed to be rolling passively in the trough of the sea.

(2) The waves to which she is exposed are supposed to form a regular independent series, successive waves having the same dimensions and periods.

(3) The waves are supposed to be large as compared with the ship, so that at any instant she would rest in equilibrium with her masts coincident with the corresponding normal to the "effective slope," which is commonly assumed to coincide with the upper surface of the wave.

(4) The righting moment of the ship at any instant is assumed to be proportional to the angle of inclination of her masts to the corresponding normal to the effective wave slope—the virtual upright.

(5) The variations of the apparent weight are supposed to be so small, when compared with the actual weight, that they may be neglected, except in very special cases.

(6) The effects of fluid resistance are considered separately, and in the mathematical investigation the motion is supposed to be unresisted and isochronous (see p. 157).

Objections may be raised, with justice, against most of these assumptions; and it was never intended that they should be regarded as including all the varying circumstances which may influence the rolling of a ship among waves. The results of experience and observation, however, confirm the general accuracy of the deductions drawn from mathematical investigations based upon these assumptions; and this is one great recommendation in their favour. Another fact worthy of notice is that no better and more complete assumptions have been proposed on which to base a rigorous mathematical investigation of the rolling of ships among waves. Many attempts have been made in this direction, but the conclusion reached up to the present time is that the problem lies beyond the reach of purely mathematical treatment, and can only be successfully attacked by the process of "graphic integration," to be described hereafter.

Two principal objections to the foregoing assumptions may be mentioned in passing. It may be thought that since ships much more frequently encounter a "confused sea" than a single regular series of waves, the latter condition should not be supposed to exist. In reply it may be stated that extensive observations of the behaviour of ships seem to show that the irregularities of a confused sea often tend to check the accumulation of rolling, the heaviest rolling being produced by waves which are approximately regular. No doubt there are exceptions to this rule; but, unfortunately, the attempt to express the conditions of a confused sea in the mathematical investigation renders the latter unmanageable. Objection may be taken also to the assumption that the ships shall be regarded as small in comparison with the waves. This is not always true; yet it must be noted that—excluding the special case of synchronous oscillations—the heaviest rolling is usually produced by the largest waves, while the supposition of relative smallness is favoured by the smallest dimension of the ship—her beam—being presented to the length of the wave.

Upon the basis of the foregoing assumptions, dynamical equations are formed representing the unresisted rolling of the ships. The following are the principal steps. Some fixed epoch is chosen wherefrom to reckon the time at which the ship occupies a certain position on the wave slope, and has an inclination (θ) to the vertical.

The inclination (θ_1) to the vertical of the wave normal for that position can then be expressed in terms of the steepness of the wave and the wave period; both ascertainable quantities. Next the angle ($\theta - \theta_1$) between this normal and the masts can be deduced from the preceding expressions; and the righting moment corresponding to that angle can be estimated. This moment constitutes the active agency controlling the motion of the ship at that instant, and it must be balanced by the moment of the accelerating forces, which can be expressed in terms of the inertia of the ship and the angular acceleration.* Finally, an equation is obtained involving the following terms: The angular acceleration at that instant; the inclination of the masts of the ship to the vertical at that instant; and the effort of stability at that instant. The solution of this equation furnishes an expression for the angle of inclination (θ) of the ship to the vertical at any instant, in terms of her own natural period, the wave period, the ratio of the height to the length of the wave, and certain other known quantities. Assuming certain ratios of the period of the ship to the wave period, it is possible from the solution to deduce their comparative effect upon the rolling of the ship; or, assuming certain values for the steepness of the waves, to deduce the consequent rolling as time elapses and a continuous series of waves passes the ship. In fact, the general solution gives the means of tracing out the unresisted rolling of a ship for an unlimited time, under chosen conditions of wave form and period. A few of the more important cases may now be briefly mentioned.

One critical case is that in which the natural period of the ship for a single roll equals the half-period of the wave. This had been foreseen by several of the earlier writers, including Daniel Bernoulli, apart from mathematical investigation, from the analogy between the motions of a ship and a pendulum. It is a matter of common experience that, if a pendulum receive successive impulses, keeping time with (or "synchronizing" with) its period, even if these impulses have individually a very small effect, they will eventually impress a very considerable oscillation upon the pendulum. A common swing receiving a push at the end of each oscillation is a case in point. When a similar synchronism occurs between the wave impulse and the period of the ship, the passage of each wave tends to add to the range of her oscillation, and were it not for the deterrent action of the fluid resistance, she would finally capsize. Such, in general terms, was the opinion of the earlier writers, which recent and more exact investigations have fully confirmed. Apart from the action of resistance, it has been shown that the passage of

* See the explanations of these terms given at p. 149.

a single wave would increase the range of oscillation of the ship by an angle equal to about three times the maximum slope of the wave. For instance, in an Atlantic storm wave series, each wave being 250 feet long and 13 feet high, and having a maximum slope of some 9 degrees, the passage of each wave would, if there were no resistance, add no less than 27 degrees to the oscillation of the ship; so that a very few waves passing her would overturn her. Here, however, the fluid resistance comes in, and puts a practical limit to the range of oscillation in a manner that will be explained hereafter.

It may be well to examine a little more closely into the character of the wave impulse which creates accumulated rolling in this case. Suppose a vessel to be broadside-on in the wave hollow when the extremity of her roll is reached, say to starboard, the waves advancing from starboard to port. Then the natural tendency of the ship, apart from any wave impulse, will be to return to the upright in an interval equal to one-half her period, which by hypothesis will be equal to the time occupied by the passage of one-fourth the wavelength. In other words, the ship would be upright midway between hollow and crest of the wave near which its maximum slope occurs. Now, at each instant of this return roll towards the upright the inclination of the wave normal, fixing the direction of the resultant fluid pressure, is such as to make the angle of inclination of the masts to it greater than their inclination to the true vertical; that is to say, the inclination of the wave normal at each instant virtually causes an increase of the righting moment. Consequently, when the vessel reaches the upright position at the mid-height of the wave, she has by the action of the wave acquired a greater velocity than she would have had if oscillating from the same initial inclination in still water. She therefore tends to reach a *greater inclination* to port than that from which she started to starboard; and this tendency is increased by the variation in direction of the wave normal between the mid-height and the crest—that part of the wave which is passing the ship during the period occupied by the second half of her roll. On reference to Fig. 83—where the directions of the wave normal are indicated by the masts of the rafts—it will be seen that, when the ship during the second half of the roll inclines her masts away from the wave crest, the angle between the masts and the wave normal is constantly less than the angle they make with the vertical. The effect of this is to make the righting moment less at every instant during the second half of the roll on the wave than it would have been in still water. For unresisted rolling, it is the work done in overcoming the resistance of the righting couple which extinguishes the motion away from the vertical. On the wave, therefore, the vessel will go further to the other side of the vertical

from that on which she starts than she would do in still water, for two reasons: (1) she will acquire a greater velocity before she reaches the upright; (2) she will experience a less check from the righting couple after passing the upright. From the above statements it will be evident that there must be a direct connection between the maximum slope of the wave and the successive increments of her oscillations.

More or less close approximation to this critical condition will give rise to more or less heavy rolling; but it is a noteworthy fact that, even where the natural period of the ship for small oscillations equals the half-period of the wave, and may thus induce heavy rolling, the synchronism will almost always be disturbed as the magnitude of the oscillations increases; the period of the ship will be somewhat lengthened, and thus the further increments of oscillation may be made to fall within certain limits, lying within the range of stability of the ship. It will be understood that this departure from isochronism in no way invalidates what was said in Chapter IV. as to the isochronism of ships of ordinary form when oscillating 10 or 15 degrees on either side of the vertical. The character of the change can best be illustrated by reference to a common simple pendulum. Such a pendulum swinging through very small angles on either side of the vertical has, say, a period of one second; if it swings through larger angles, its period becomes somewhat lengthened, and the following table expresses the change:—*

Angles of swing.	Period.
	seconds.
Very small	1·0
30°	1·017
60°	1·073
90°	1·183
120°	1·373
150°	1·762

For ships the angles of swing are rarely so large as to make the increase of period great proportionally, but yet, as above remarked, the increase may be sufficient to add sensibly to the safety of a ship exposed to the action of waves having a period double of her own period for small oscillations; although it is by the action of fluid resistance that the overturning of a ship so circumstanced is chiefly prevented.

* See Report of Committee on Devastation class. *Devastation* class.
 signs (1871), where Professor Rankine applied similar reasoning to the dis-

A second interesting deduction from the solution of the general equation for unresisted rolling is found in the "permanent oscillations of ships." If a vessel has been for a long while exposed to the action of a single series of waves, she may acquire a certain maximum range of oscillation, and perform her oscillations, not in her own natural period, but in the possibly different wave period. This case differs from the preceding one in that the period of the ship for still-water oscillations does not agree with the half-period of the wave; but, notwithstanding, the oscillations among waves keep pace with the wave, their period being "forced" into coincidence with the half-period of the wave. At the wave hollow and crest a ship so circumstanced is upright; she will reach her maximum inclination to the vertical when the maximum slope of the wave is passing under her (about the mid-height of the wave); and the passage of a long series of waves will not increase the range of her oscillations, which are "permanent" in both range and period—hence their name. The maximum inclination then attained depends, according to theory, upon two conditions: (1) the maximum slope of the wave; (2) the ratio of the natural period of oscillation of the ship to one-half the wave period.

Let α = maximum angle made with the horizon by the wave profile;

θ = maximum angle made with the vertical by the masts of the ship;

T = natural period of still-water oscillations of the ship;

$2T_1$ = period of wave.

If fluid resistance is neglected, and the conditions above stated are fulfilled, mathematical investigation for this extreme case leads to the following equation:—

$$\theta = \alpha \cdot \frac{1}{1 - \frac{T^2}{T_1^2}} = \frac{\alpha \times T_1^2}{T_1^2 - T^2}$$

Three cases may be taken in order to illustrate the application of this equation.

I. Suppose $T = T_1$, then θ becomes *infinity*; that is to say, we have once more the critical case of synchronism previously discussed, respecting which nothing need be added.

II. Suppose T less than T_1 , so that $\frac{T^2}{T_1^2}$ is a proper fraction less than unity: then θ and α always have the same sign, which indicates that the masts of the ship lean away from the wave crest at all positions, except when the vessel is upright at hollow and crest. The closer the approach to equality between T_1 and T , the greater

the value of θ ; which is equivalent to an enforcement of the statement previously made, that approximate synchronism of periods leads to heavy rolling. The smaller T becomes relatively to T_1 , the smaller does θ become, its minimum value being α when T is indefinitely small relatively to T_1 . This is the case of the raft in Fig. 83, which keeps its masts parallel to the wave normal.

III. Suppose T greater than T_1 : then θ and α are always of opposite signs, and, except at hollow and crest, the masts of the ship always lean towards the wave crest. The nearer to unity is the ratio of T to T_1 , the greater is θ ; illustrating as before the accumulation of motion when there is approximate synchronism. The greater T becomes relatively to T_1 , the less does θ become; in other words, as explained above, a ship of very long period keeps virtually upright as the wave passes.

As an example of the use of the formula, take the following figures drawn from the report on the behaviour of the *Devastation* during a passage to the Mediterranean:—

α = maximum wave slope = $1\frac{1}{2}$ degrees;

T = natural period of ship for single roll . . = 6.8 seconds;

T_1 = half (apparent) wave period = 6 "

If the conditions of permanent rolling had been fulfilled, the formula would give—

$$\left. \begin{array}{l} \text{Maximum inclination of ship, sup-} \\ \text{posing motion unresisted} \end{array} \right\} = 1\frac{1}{2} \times \frac{1}{1 - \left(\frac{6.8}{6}\right)^2}$$

$$= 1\frac{1}{2} \times \frac{1}{1 - 1.28} = 5\frac{1}{3} \text{ degrees (nearly).}$$

The observed oscillation of the ship, from out to out, at this time was about 7 degrees, and the less magnitude of this oscillation, as compared with that given by the formula, must be accounted for chiefly by the want of absolute uniformity in a sufficiently long series of waves to make the rolling permanent, as well as by the steadying effect of the resistance. The example has, however, been given merely as an illustration of the use of the formula, not as a proof of its accuracy; in practice all deductions from the theory of unresisted rolling, as to the *extent* of oscillation, require to be modified to allow for the effect of fluid resistance. An inspection of the records of rolling of a large number of ships, under various conditions of sea, leads to the conclusion that the periods are rarely "forced" into coincidence with the wave-period.

It is possible, by means of very simple experiments, to illustrate the influence which changes in the relative periods of ships and

waves may have upon the rolling.* Let AB, Fig. 93, represent a pendulum with a very heavy bob, having a period equal to the half period of the wave. To its lower end let a second simple pendulum, BC, be suspended, its weight being inconsiderable as compared with

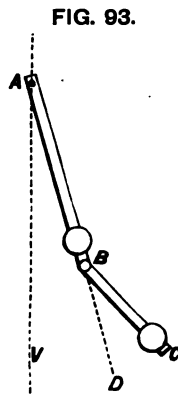

the wave pendulum AB; then, if AB is set in motion, its inertia will be so great that, notwithstanding the suspension of BC, it will go on oscillating very nearly at a constant range—say, equal to the maximum slope of the wave—on each side of the vertical. First suppose BC to be equal in length and period to AB; then, if the compound pendulum is set in motion, and AB moves through a small range, it will be found that BC, by the property of synchronizing impulses, is made to oscillate through very large angles. Second, if BC is made very long, and of long period, as compared with AB, it will be found that BC continues to hang nearly vertical while AB swings, just as the ship of comparatively long period remains upright, or nearly so, on the wave. Third, if BC is made very short and of small period when AB is set moving, BC will always form almost a continuation of AB, just as the quick-moving ship keeps her masts almost parallel to the wave normal.

A third notable deduction from the solution of the equation for unresisted rolling is that, except when the conditions of synchronism or permanent oscillation are obtained, the rolling of a ship will pass through phases. At regular stated intervals equal inclinations to the vertical will recur, and the range of the oscillations included in any series will gradually grow from the minimum to the maximum, after attaining which it will once more decrease. The time occupied in the completion of a phase depends upon the ratio of the natural period of the ship to the wave period. If T = ship's period for a single roll, T_1 = half-period of wave, and the ratio of T to T_1 be expressed in the form $\frac{p}{q}$, where both numerator (p) and denominator

(q) are the lowest *whole numbers* that will express the ratio: then—

Time occupied in the completion of a phase = $2q \cdot T$ seconds.

For example, let it be assumed that waves having a period of 9 seconds act on a ship having a period (for single roll) of $7\frac{1}{2}$ seconds.

$$\text{Then } \frac{T}{T_1} = \frac{7\frac{1}{2}}{4\frac{1}{2}} = \frac{15}{9} = \frac{5}{3} = \frac{p}{q}$$

Time for completion of phase = $3 \times 2 \times 7\frac{1}{2} = 45$ seconds.

* Such experiments were made some years ago by the late Professor Rankine, and by the author in connection with his lectures at the Royal Naval College.

Although the mathematical conditions for these “phases” of oscillation are not fulfilled in practice, the causes actually operating on the ship—such as the differences in form of successive waves, and the influence of fluid resistance—commonly produce great differences in the successive arcs of oscillation. It is important, therefore, in making observations of rolling, to continue each set over a considerable period. In the Royal Navy each set of observations extends over ten minutes, and the minimum inclinations reached are always found to differ considerably from the maximum inclinations. The mean oscillation for any set is frequently only a little more than half the maximum inclination, and the following examples are fairly representative in this respect.

DETACHED SQUADRON (1874).

Ships.	Mean arcs of oscillation.	Maximum arcs of oscillation.
	degrees.	degrees.
<i>Newcastle</i>	29·6	58
<i>Topaze</i>	22·6	50
<i>Immortalité</i>	20·0	39
<i>Narcissus</i>	19·6	36
<i>Doris</i>	18·7	48
<i>Raleigh</i>	5·8	15

CHANNEL SQUADRON (1873).

Ships.	Mean arcs of oscillation.	Maximum arcs of oscillation.
	degrees.	degrees.
<i>Bellerophon</i>	16·9	25
<i>Minotaur</i>	22·3	46
<i>Agincourt</i>	16·4	37
<i>Hercules</i>	8·1	14
<i>Sultan</i>	6·6	12

In comparing the rolling of ships, it is usual to take the mean arcs of oscillation (*i.e.* the mean of the sums of successive inclinations on either side of the vertical), and on the whole this appears the fairest course. But in analyzing rolling returns, it is always desirable to look further, and to note the maximum and minimum oscillations, as well as the rate of growth of the range. All these particulars are readily ascertainable from the forms upon which the records of rolling are kept in the Royal Navy. For considerations of safety, the maximum angle of inclination reached is obviously of the greatest importance; but vessels do not usually roll so heavily as

to be liable to capsize, and, apart from this danger, the mean oscillations afford the best means of comparing the behaviour of ships.

In concluding these remarks on the hypothetical case of *unresisted* rolling among waves, it may be well to summarize the conclusions which have the greatest practical interest, and to compare them with the results of experience. It need scarcely be remarked again that the actual behaviour of ships at sea is greatly influenced by fluid resistance.

First. Heavy rolling is likely to result from equality or approximate equality of the period of a ship and the half-period of waves, even when the waves are very long in proportion to their height. Many facts might be cited in support of this statement, but a few must suffice. Admiral Sir Cooper Key observed that the vessels of the *Prince Consort* class were made to roll very heavily by an almost imperceptible swell, the period of which was just double that of the ships. Admiral Sir R. Vesey Hamilton noted that, on one occasion, the *Achilles*, a vessel having a great reputation for steadiness, rolled more heavily off Portland in an almost dead calm than she did off the coast of Ireland in very heavy weather. Mr. Froude reported a very similar circumstance as having occurred during trials with the *Active*. And, lastly, during the cruise of the combined squadrons in 1871, when the *Monarch* far surpassed most of the ships present in steadiness in heavy weather, there was one occasion when, through the action of approximately synchronizing periods, she rolled more heavily in a long swell than did the notoriously heavy rollers of the *Prince Consort* class.

The effect of approximate synchronism of periods may be tested by changing the course of a ship relatively to the advance of the waves, and this was done most satisfactorily during the trials of the *Devastation*, the ship remaining in the same condition, and the waves, of course, remaining unchanged, while the *apparent period* of the waves was altered by change of course and speed.* Lying passively broadside-on to waves having a period of about 11 seconds, the *Devastation* was observed to roll through the maximum angles of $6\frac{1}{2}$ degrees to windward, and $7\frac{1}{2}$ degrees to leeward, making the total arc 14 degrees. She was then put under way, and steamed away from the waves at a speed of $7\frac{1}{2}$ knots, having the wind and sea on her quarter, when her maximum roll to windward became 13 degrees, and to leeward $14\frac{1}{2}$ degrees, making the total arc $27\frac{1}{2}$ degrees. The difference between the two cases is easily explained, in view of the foregoing considerations. When rolling passively in the trough of the sea, the apparent period of the waves was their real period; and

* For an explanation of the term "apparent period," see p. 208.

this was less than the double period for the *Devastation* ($13\frac{1}{2}$ seconds). When she steamed away obliquely to the line of advance of the waves, their apparent period became increased, and the diagrams of the ship's performance then taken showed that the speed and course of the ship had the effect of making the apparent period of the waves just equal to the period of a double roll for the *Devastation*—in fact, established that synchronism of ship and wave which is most conducive to the accumulation of motion.

This case also furnishes an example of what to every sailor is a truism, viz. that the behaviour of a ship is greatly influenced by her course and speed relatively to the waves. Theory, as we have shown, takes account of the case which is probably the worst for most vessels—the condition of a ship which has become unmanageable, and rolls passively in the trough of the sea. But so long as a ship is manageable, the officer in command can largely influence her behaviour by the selection of the course and speed, which make the ratio of the periods of ship and wave most conducive to good performance. In the case of the *Devastation* just cited, had she steamed obliquely, as before, but head to sea, the apparent period of the waves would have been decreased, and the rolling would probably have been less than it was in either case recorded. Of course, synchronism in some cases may be produced by steaming towards, instead of from, the waves. For instance, if a ship having a period of 4 to 5 seconds had been amongst the waves which the *Devastation* encountered, when broad-side-on, her period would have been less than half that of the waves; but if she had steamed obliquely towards the waves, their apparent period might have been lessened, and made about 8 to 10 seconds. However obtained, such synchronism will probably lead to the heaviest rolling the vessel is likely to perform, and the steeper the waves the heavier is the rolling likely to be.

Second. It follows from the investigation for unresisted rolling that the best possible means, apart from increase in the fluid resistance, of securing steadiness in a seaway, is to give to a ship the longest possible natural period for her still-water oscillations. This deduction it is which has been kept in view in the design of most recent war-ships, both English and foreign, and its correctness has been fully established by numerous observations.

It would be easy to multiply illustrations from the published record of rolling of the ships of the Royal Navy, as well as from those of the French Navy; but we can only give a few, referring the reader to the original documents for more.* During the cruise

* See *Parliamentary Papers*, "Reports on Channel Squadrons," 1863-68; the Report of the Admiralty Committee on Designs for Ships of War of 1871; and various reports on the behaviour of ships in the French Navy.

of the Combined Squadron in 1871, some of the "converted" ironclads of the *Prince Consort* class, and other of the earlier ironclads having short periods, were in company with armoured ships of more recent design, having longer periods. The following table of observations refers to a time when the weather was reported to be exceptionally heavy, but unfortunately no particulars were noted of the dimensions and periods of the waves.

Ships.	Approximate natural periods.	Arcs of oscillation.
	seconds.	degrees.
<i>Lord Warden</i>	} 5 to 5½	{ 62
<i>Caledonia</i>		
<i>Prince Consort</i>		
<i>Defence</i>		
<i>Minotaur</i>	} 7 to 7½	{ 49
<i>Northumberland</i>		
<i>Hercules</i>		
	8	25

It may be interesting to note that the period of the *Prince Consort* class, from 5 to 5½ seconds, would just synchronize with the half-period of waves from 500 to 600 feet long. It has been stated in the preceding chapter that these are almost identically the dimensions which careful and extensive observations have led us to accept as belonging to large Atlantic storm-waves. Hence it is easy to explain the relatively bad behaviour of these converted ironclads with their quick motion and short period. Another illustration of the superior steadiness of ships of long period may be drawn from the observed performances of the representative ships in the Channel Squadron of 1873, as under:—

Ships.	Approximate natural periods.	Mean arcs of oscillation.
	seconds.	degrees.
<i>Bellerophon</i>	} 6½ to 7	{ 16·9
<i>Minotaur</i>		
<i>Agincourt</i>	} 7 to 7½	{ 22·3
<i>Hercules</i>		
<i>Sultan</i>		
	8·0	8·1
	8·9	6·6

This, it should be understood, is a fairly representative case, and by no means an exceptional one. In the French Navy similar results have been obtained. Almost at the outset of the ironclad reconstruction, the returns from the French experimental squadron of 1863 furnished evidence of the same kind, as the following table

shows. The observations were made when the vessels were running broadside-on to a heavy sea.

Ships.	Approximate natural periods.	Mean arcs of oscillation.
	seconds.	degrees.
<i>Normandie</i>	} 5 to 5½	{ 43·6
<i>Invincible</i>		
<i>Couronne</i>	6	37·7
<i>Magenta</i>	} 7 to 7½	{ 36·0
<i>Solferino</i>		

The *Magenta* and *Solferino* were making only ten oscillations per minute, whereas the other ships were making twelve.

Another striking contrast is to be found in the behaviour of the French ironclad *Océan* and other vessels of her class, having periods of about 10 seconds for a single roll, as compared with the behaviour of the armoured corvettes of the *Alma* class having periods varying from 5½ to 5·7 seconds for a single roll. It is recorded that in the first cruise of the *Océan* she never rolled more than 2 to 3 degrees on each side of the vertical, while three of the corvettes were rolling 34, 35, and 36 degrees from the vertical. The maximum inclination to the vertical reached by the *Océan* under any circumstances during this cruise never exceeded 7 degrees. Experience with the ships of the *Invincible* class in the Royal Navy has given no less satisfactory results. The commanding officer of one of these ships has stated "that they may go through a commission and never heel or roll more than one or two degrees."

Records of rolling have been mostly limited to the behaviour of armoured ships, the apprehensions entertained in some quarters as to the unseaworthiness of these vessels having caused greater attention to be bestowed upon them than upon unarmoured vessels. But now that rolling returns have been ordered to be made in all her Majesty's ships, a large mass of facts relating to unarmoured as well as armoured ships has been collected, and is continually being increased. The Detached Squadron has in this way enabled a good comparison to be made between the behaviour of early types of screw-frigates, forming the main strength of the squadron, and that of the swift cruisers which have been in company—particularly the *Inconstant* and the *Raleigh*, both ships of long period. The following table is taken from the observations of rolling made in the heaviest weather experienced by the squadron in the spring of 1875, and, like the other examples given, is only a specimen of many similar cases :—

Ships.	Approximate natural periods.	Mean arcs of oscillation.
<i>Newcastle</i> <i>Topaze</i> <i>Immortalité</i> <i>Narcissus</i> <i>Doris</i> <i>Raleigh</i>	seconds.	degrees.
	5	29·6 22·6 20·0 19·6 18·7
	8	5·8

In passing, it may be well to illustrate the importance of the slower motion being associated with the smaller arc of oscillation in ships rolling at sea. In the table on p. 244, compare the behaviour of the *Lord Warden* with that of the *Hercules*; the former rolling through an arc of 62 degrees about eleven or twelve times each minute, while the latter rolled through 25 degrees only about seven or eight times each minute. A man aloft, say, at a height of 100 feet, in the *Lord Warden* would be swept through the air at a mean rate of some 1200 feet per minute, having the direction of his motion reversed about every 5 seconds; whereas a man placed as high in the *Hercules* would only be moving at a mean rate of some 350 feet per minute, and be subjected to a reversal of the direction only about once every 8 seconds. The maximum rates in passing through the vertical would of course be greater than these mean rates. Hereafter it will be shown how great are the strains brought upon the structure, masts, and rigging of ships which roll violently and rapidly.

The remarks on wave genesis made in the previous chapter will assist the explanation of the undoubtedly greater average steadiness of vessels of long natural periods. What may be termed ordinary storm winds may by their continued action produce waves having lengths of 600 feet or under, with periods of 10 to 11 seconds or less; and these waves would have half-periods about equal to the still-water periods of the wooden screw-frigates of the older type and the converted ironclads. Extraordinary conditions would, on the other hand, be required to produce waves having periods double the still-water periods now commonly given to the largest war-ships armoured and unarmoured; for these waves would be from 1200 to 1500 feet in length—sizes that have been noted, but are not often encountered. Before such waves could have reached these enormous dimensions, they would probably have passed through a condition resembling that of the ordinary storm wave; and although, in becoming degraded, they may lose in their lengths much more slowly than they do in their heights, yet they may once more, before

dying out, approach the lengths and periods of the ordinary storm wave, being less steep than that wave when fully grown. It appears probable, therefore, that the ship of long period (say 7 to 9 seconds) will much less frequently fall in with waves synchronizing with her own natural period than will the vessel of shorter period (say 4 to 6 seconds); and when these large waves are encountered, their chance of continuance is much less than that of smaller waves; so that on both sides the slower-moving ship gains, when rolling passively in the trough of the sea.

Changes of course and speed of the ship relatively to the waves, as before explained, affect the relation between the periods, and may either destroy or produce the critical condition of synchronism. But this is equally true of both classes of ship, and as long as they remain under control, all ships may have their behaviour largely influenced by such changes, whether their period be long or short. When synchronism is the result of obliquity of course relatively to the waves, it implies the retention of control over the vessel by her commander; for when she becomes unmanageable, a vessel falls off into the trough of the sea. Hence such synchronism in the case of vessels of naturally long period may be easily avoided by change of course; for them rolling passively broadside-on to the longest waves of ordinary occurrence is not the worst condition (see previous case of the *Devastation*). On the contrary, the vessels of shorter period would occupy their worst position relatively to such waves when rolling passively in the trough of the sea. In short, synchronism of periods usually results only from obliquity of course in the vessels of long period; it can only be avoided in storms of average severity by obliquity of course in the quicker-moving ships.

One other important point of difference between very long waves and ordinary large storm waves is the much less comparative steepness of the former. The fact was illustrated in the previous chapter; its bearing upon the behaviour of ships will be obvious if the previous remarks on the influence of the maximum wave slope are recalled to mind. It has been shown that the upper limit attained during rolling motion is very largely governed by that slope, as well as by the ratio of the periods. Hence, for a certain fixed ratio of periods, that ship will fare best which encounters the flattest and longest waves. Probably few waves having the large periods of 13 to 16 seconds have slopes exceeding 4 or 5 degrees; whereas waves having periods of 8 or 10 seconds have been observed to slope 9 or 10 degrees to the horizon. Moreover, when the condition of synchronism of periods results from the oblique motion of a ship relatively to waves, that obliquity produces a virtual reduction of

the wave slope, and thus favours ships of long period when rolling among ordinary storm waves.

Third. It appears from the investigation of unresisted rolling that vessels having very quick periods, say 3 seconds or less for a single roll, fare better among ordinary large storm waves than vessels having periods of 4 to 6 seconds. The tendency in these very quick-moving vessels is to acquire a fixed range of oscillation, keeping their decks approximately parallel to the effective wave slope, as described for the little raft in p. 202. As examples, the deep-sea fishing-boats used off the Dutch coast at Scheveningen may be named; and amongst war-ships, the American monitor type. It is reported of the *Miantonomoh*, which crossed the Atlantic in 1866, with a height of upper deck above water of only 3 feet, that she rolled but moderately in heavy weather, and shipped very little water on her low deck, even when broadside-on to large waves, the water which did come on the deck on the weather side usually passing off again on the same side as that it broke over. This is very good evidence that the motions of the monitor were so quick relatively to the wave motion that her deck was kept approximately parallel to the surface. Obviously such a vessel would not be a steady gun-platform, as the range of her oscillation might be considerable, being governed by the wave slope. For instance, if the *Miantonomoh* were placed broadside-on to Atlantic storm waves, 600 feet long and 30 feet high, the maximum slope of the wave would be about 9 degrees, and its period about 11 seconds. Once in every $5\frac{1}{2}$ seconds (the half-wave period), therefore, if the ship kept pace with the wave, she would really swing through a total arc of 18 degrees—9 degrees on either side of the vertical, although to an observer on board, owing to causes explained in the preceding chapter, she might seem to continue nearly upright. The wave period is about twice the natural period for a double roll of the monitor. In other words, while the wave normal or virtual upright in $5\frac{1}{2}$ seconds completed a single set of motions between the hollow and the crest, the monitor could move twice as quickly, and might therefore keep her deck nearly parallel to the surface.

When this quickness of motion is obtained by the adoption of great beam a vessel has the further advantage (explained above) of a very flat effective wave-slope, so that her range of oscillation may be very limited even among large waves. The Russian circular ironclads and the *Livadia* are examples of this class. They are reported to be wonderfully steady; and in exceedingly heavy weather in the Bay of Biscay, the maximum roll of the *Livadia* is stated to have been only 4 degrees.

Somewhat different conditions hold in the cases of small sea-

going vessels, for which the still-water periods are made short by the smallness of their moment of inertia, and the necessity for retaining a sufficient amount of stiffness. For such vessels the effective slope is very nearly the upper surface of the waves, and their range of oscillation among large waves is practically determined by the wave-slope. Amongst smaller waves, approaching the condition of synchronous periods, these small vessels are worse off than very broad vessels of identical period, because the effective slope for the broad vessels is so much flatter. In fact, a small vessel of 3 seconds' period among waves of about 180 feet in length, might accumulate motion and roll heavily, much as larger vessels of from 4 to 6 seconds' period have been shown to do among ordinary large Atlantic waves. The *Livadia*, on the contrary, with her beam of 150 feet, might remain almost free from rolling, even when her period was nearly identical with that of the waves. On the other hand it must be noted, and will be more fully illustrated hereafter, that in these small vessels the accumulation of rolling motion may be checked by the use of bilge-keels to an extent not possible in larger vessels.

Resisted Rolling among Waves.—Only a passing notice has been bestowed hitherto upon the very important effects of fluid resistance in modifying the rolling of ships among waves. This branch of the subject is, however, of great interest, and has attracted the attention of several able investigators. Although they are not agreed in all points, there are many general considerations which command universal support; to some of these brief reference will now be made.

The deductions from the hypothetical case of isochronous *unresisted* rolling, to which attention has been drawn, can be regarded only as of a qualitative and not of a quantitative character. For example, one of these deductions is that a ship rolling isochronously and unresistedly among waves having a period double her own natural period will accumulate great rolling motion, and infallibly upset. As a matter of fact, we know that, while the assumed ratio of periods leads to the production of heavy rolling, ships do not commonly, nor in any but exceptional cases, upset under the condition of synchronism. Although the *character* of the motion is well described by the deduction from the hypothetical case, its *extent* is not thus to be measured. Similarly, in other cases, the effect of resistance and change of period with increased arcs of oscillation must be considered when exact measures of the range of oscillation are required, as they may be in discussing the safety of ships. The problem, therefore, resolves itself into one of correcting the deductions from the hypothetical case of isochronous unresisted

rolling, by allowing for departures from isochronism as rolling becomes heavier, and by the consideration of the effect of fluid resistance.

In accordance with the principles explained in Chapter IV., it is possible by means of still-water rolling experiments to ascertain the amount of resistance of a ship corresponding to any assigned arc of oscillation. If the ship herself has not been rolled for that purpose, but a model or a sister ship or similar vessel has been so rolled, her coefficients of resistance may be estimated with close approximation, and the retarding effects of resistance may be determined. This is true within the limits of oscillation reached by the still-water experiments, say 10 or 15 degrees on each side of the vertical, and in high-sided ships of ordinary form the limits may probably be extended. In fact, it may be assumed that the coefficients of resistance for most ships are, or may be ascertained by rolling experiments, for inclinations as great as are likely to be reached by the same ships when rolling in a seaway, in all but exceptional circumstances.

If a vessel rolls through a certain arc amongst waves, it appears reasonable to suppose that the effect of resistance will be practically the same as that experienced by the ship when rolling through an equal arc in still water. The intrusion of the vessel into the wave, as already remarked, must somewhat modify the internal molecular forces, and she must sustain certain reactions, but for practical purposes these may be disregarded.

Resistance is always a retarding force; in still water it tends to extinguish oscillation; amongst waves it tends to limit the maximum range attained by the oscillating ship. This may be well seen in the critical case of synchronism; where a ship rolling unresistedly would have a definite addition made to her oscillation by the passage of each wave. The wave impulse may be measured by the added oscillation; the dynamical stability corresponding to the increased range expressing the "energy" of the wave impulse. At first the oscillations are of such moderate extent that the angular velocity is small, and the wave impulse more than overcomes the effect of the resistance; the rolling becoming heavier. As it becomes heavier, so does the angular velocity increase, and with it the resistance. At length, therefore, the resistance will have increased so much as to balance the increase of dynamical stability corresponding to the wave impulse—then the growth of oscillation ceases. As successive waves pass the ship after this result is attained, they each deliver their impulse as before, but their action is absorbed in counteracting the tendency of the resistance to retard and degrade the oscillations.

When a ship is rolling "permanently" amongst waves, her

oscillations having a fixed range and period, a similar balance will probably have been established between the wave impulse and the resistance; and here also the actual limit of range will fall below the theoretical limit given by the formula for unresisted permanent rolling on p. 238. The influence of resistance may, in this case, be viewed as similar to that of a reduction in the *steepness* of the waves; this diminished slope taking the place of what has been termed the "effective slope" for unresisted rolling.

Assuming that the coefficients of resistance for a ship have been determined experimentally, and that the curve of stability has been constructed, it is possible to trace her behaviour among waves of any selected form by means of the process of "graphic integration," introduced by the late Mr. Froude. This process must be regarded as the most valuable means yet suggested for approximating to the maximum rolling to which a ship is likely to be subjected in a seaway, and for pronouncing upon her safety against or liability to capsizing. It has already been applied in certain critical cases, and its accuracy has been confirmed by comparisons of the results obtained by its use with the actual behaviour of ships.* No detailed description of the process can be given here, but it may be interesting to give an illustration of its application. Fig. 94 contains the result

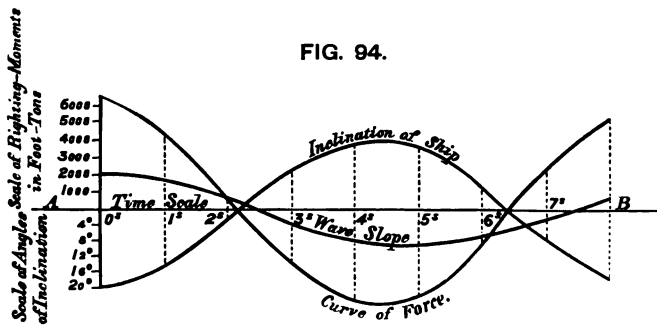

of an investigation made for H.M.S. *Endymion* when rolling, with no sail set, among waves 512 feet long and 22 feet high. On the base-line *AB*, abscissæ-measurements correspond to *time* reckoned from some selected epoch. Any ordinate of the curve of "wave slope" shows the slope of the effective wave surface to the horizon at the instant fixed by the corresponding abscissa. Similarly any ordinate of the curve of "inclination of ship" shows the angle which her masts

* For an example of these comparisons see the appendix to the Report of the *Inflexible* Committee (*Parliamentary Paper C-1917* of 1878); and

for a detailed account of the process of graphic integration, see the *Transactions* of the Institution of Naval Architects for 1875 and 1881.

make with the vertical at the corresponding time. Hence it follows that the intercepts, or lengths of ordinate, between the curves of inclination and wave slope show for each instant the angle of inclination of the masts of the ship relatively to the normal to the wave slope, which angle, as previously explained, governs the virtual righting moment, and enables an opinion to be formed as to the stability or instability of a ship. The "curve of force" in Fig. 94 has ordinates representing successive values of the moment of the impressed forces acting on the ship. For example, in the case under consideration, the moment of the impressed forces at any time includes the instantaneous righting moment and the instantaneous moment of resistance. During certain parts of the motion of the vessel the instantaneous righting moment tends to add to her angular velocity, while the moment of resistance tends to diminish it; the corresponding ordinates of the force curve then represent the *differences* between the moments. During other parts of the motion the righting moment, as well as the moment of resistance, tends to retard the angular velocity; and the corresponding ordinates of the force curve represents the *sums* of the moments. In building up the force curve it is necessary to know, therefore, instant by instant the inclination of the masts of the ship to the wave-normal and her angular velocity, because the instantaneous righting moment depends upon that inclination, while the moment of resistance is governed by the angular velocity. The process is really one of "trial and error," but each step admits of a complete check and verification in consequence of the inter-dependency of the curve of inclinations and the force curve. In practice, the work of graphic integration can be rapidly performed, and after certain preliminaries have been arranged in any particular case, the remaining steps are very simple.

It will be understood that the process of graphic integration is based on strict mathematical reasoning; but it surpasses any purely mathematical investigation in its inclusion of the effect of fluid resistance, and in its scope of application. By means of this process the rolling of a ship in the most confused seaway can be approximated to, the appropriate curve of wave-slope being supposed to be known. The behaviour of the same ship under different conditions of sea can be compared; the probable effects of changes in bilge-keels, etc., can be investigated; and the probable rolling of different types under identical conditions of sea can be contrasted. It is greatly to be desired that comparisons might be multiplied between the observed behaviour of ships and their probable behaviour deduced by means of graphic integration. Such comparisons would doubtless have the effect of still further establishing the great practical utility of the process; and they would probably throw much light upon

certain obscure questions, particularly upon those relating to the effective wave slope.

Another method of investigation for the maximum rolling of ships among waves, including the effect of fluid resistance, has been proposed by M. Bertin, and deserves mention, although it does not compare, in our judgment, with the process of graphic integration. Starting from the fundamental conception that the heaviest rolling will take place when a ship is exposed to the action of waves whose period equals the still-water period of the ship for a double roll, M. Bertin considers that, apart from the action of resistance, the passage of each half-wave would add to the amplitude of the oscillation of the ship an angle equal to the maximum slope of the effective wave surface. This estimate, it may be observed, differs somewhat from that mentioned on p. 236. Even when resistance is operating the wave form tends to add to the amplitude of successive rolls, and will do so until a range of oscillation is reached, for which the work done in overcoming the moment of resistance balances the work (or dynamical stability) corresponding to the increase of amplitude which the passage of the wave tends to create. Using M. Bertin's notation:—

- Θ = the maximum slope of the effective wave surface ;
- ϕ = the maximum amplitude of rolling ;
- N = coefficient of resistance deduced from still-water rolling experiments.

Then, as explained on p. 173, M. Bertin would write—

$$\Delta\phi = \text{loss of range due to resistance} = N\phi^2 ;$$

and on the foregoing assumptions he would also write—

$$\Delta\phi = \Theta ;$$

so that—

$$N\phi^2 = \Theta.$$

“Supposing that the quantities neglected in the calculation affect the values of ϕ in very nearly the same manner for all ships,” M. Bertin finally proposes to introduce a constant into this last equation, writing it—

$$N\phi^2 = l^2 \cdot \Theta.$$

In his examples this constant is usually omitted. For instance, *La Galissonière* has a value of $N = \cdot 0075$, and when among synchronizing waves, for which $\Theta = 9^\circ$, her maximum roll is given by the equation—

$$\sqrt{\frac{\Theta}{N}} = 34.7^\circ.$$

The reciprocal of \sqrt{N} M. Bertin terms the *coefficient d'ecclisité*.

In the examples given by him it varies from 8 or 9 in the smaller classes of unarmoured war-ships, up to 11 to 15 in armoured ships. Roughly speaking, if 9 degrees is a fair average slope for ocean waves of large dimensions, the maximum roll obtained from the above formula would be three times the *coefficient d'ecclisité*.

From this brief description it will be observed that M. Bertin here confines attention to the critical case of synchronism, and does not attempt the discussion of the limits of rolling likely to be reached by a ship among waves of other periods. He is careful to note the fact that this critical case is less likely to occur as the still-water periods of ships are lengthened; and that for certain classes of war-ships the periods are so long that they are never likely to encounter synchronizing waves. In order to meet such cases of departure from synchronism M. Bertin has proposed an empirical formula, which need not be reproduced.*

The broad practical deduction from all these investigations is that increase in the fluid resistance to the rolling of a ship tends to limit her maximum oscillations among waves. It has already been explained (see Chapter IV.) that in the use of bilge-keels is found one of the most convenient and effective methods of influencing the resistance to rolling, and that their employment is most effective in small ships of short period. Formerly some high authorities in the science of naval architecture opposed the use of bilge-keels; but extended experience has placed the matter beyond doubt, and it may be well to quote a few facts in support of this opinion. The Admiralty Committee on Designs took evidence in 1871 as to the advantages or otherwise of bilge-keels; this evidence was not unanimously favourable to the use of such keels, but its general tenour was so. Some of the Indian troopships had been fitted with deep bilge-keels at that time, and the reports of their effect on the behaviour of the ships were most definite. The captain of the *Serapis* reported that the bilge-keels, having been tried under all conditions of wind and sea, had proved a perfect success, and added, "I can confidently say her rolling has been lessened 10 degrees each way." As regarded the *Crocodile*, no similarly severe tests had at that time been made, but the opinion was expressed that "the rolling had been much checked by the bilge-pieces," the ship having often rolled heavily before they were fitted, and being considered "remarkably steady" afterwards. Mr. Froude also came forward with the reports of his experiments on models, and strongly recommended the use of deep bilge-keels—a recommendation which was endorsed

* For full details of these investigations, see "Les Vagues et le Roulis." Paris : 1877.

by the committee in their report. These experiments were made at Spithead with the same model of the *Devastation* as had previously been used to determine the effects of different depths of bilge-keels upon still-water oscillations.* At the time considerable doubt was entertained in some quarters as to the safety of the *Devastation*; and it was intended to try the model amongst waves having approximately the same period as its own for a double roll, in order to obtain a verification of the theoretical investigations of the probable behaviour of the ship when similarly circumstanced. Waves were found having the desired period, but they proved to be proportionately much steeper than any waves would be that would synchronize with the double period of the ship. Hence the trials became simply a test of the relative merits of the different bilge-keels, and in no sense a representation of the probable behaviour of the ship. The results were found to be as follows:—

Condition of model.	Maximum angle attained.
With 6 feet bilge-keel on each side . . .	5 degrees.
„ 3 feet „ „	13½ „
„ no bilge-keels	Model upset.

The deeper bilge-keels, therefore, proved very influential in limiting the range of oscillation, the waves remaining of the same character, and the variations in the depths of the keels being the only changes made during the trials.

The most complete evidence of the usefulness of bilge-keels in limiting the rolling of ships in a seaway is that afforded by the experiments made off Plymouth in 1872. Two sloops, the *Greyhound* and *Perseus*, had been placed by the Admiralty at the disposal of Mr. Froude for this purpose; the *Greyhound* was fitted with temporary bilge-keels about 3½ feet deep, which were not applied to the *Perseus*. So far as external form and dimensions were concerned, the two vessels were very similar; and by means of ballast they were made to have practically the same draught of water and still-water period; the latter being about 4 seconds for a single roll. With the one exception of the bilge-keels, the conditions influencing the behaviour of the two ships were thus made as nearly as possible identical; and their comparative rolling, when exposed simultaneously to the same series of waves, necessarily afforded a measure of the effect of the bilge-keels. When the trials were made, the

* See the accounts of these experiments at p. 176.

waves were of moderate length, and from 4 to 5 seconds' period; the two vessels were towed out and placed broadside-on to the waves, in immediate neighbourhood, but not so close to one another as to favour one by any shelter from the other. Their simultaneous rolling was then observed, and the *Perseus* was found to reach a *maximum* roll about twice as great as that for the *Greyhound*; the proportions for the mean oscillations of the two ships being much the same as those of the maximum. Thus, taking twenty successive rolls, the mean for the *Greyhound* was less than 6 degrees, whereas that for the *Perseus* was 11 degrees; the maximum inclination of the *Greyhound* during this period was about 7 degrees, that for the *Perseus* about 16 degrees. Comment upon these facts is needless.

The accidental loss of a portion of one of the temporary bilge-keels attached to the *Greyhound* at the end of these trials furnished an unlooked-for illustration of their beneficial effect. Such a loss would not be probable in a vessel with permanent bilge-keels, but the deep bilge-keels in the *Greyhound*, being fitted for experimental purposes only, were not very strongly secured to the hull, and a portion of one gave way. Its loss was not known until afterwards, but it was noticed that the behaviour of the ship had sustained a sudden change, the rolling being more heavy than before; and the cause could not be detected until the detached portion of the bilge-keel was seen floating alongside.

This careful and conclusive series of experiments does not, of course, fairly represent the ordinary conditions of bilge-keel resistance, the depth of the keels fitted to the *Greyhound* being proportionately very great indeed. But it exemplifies what may be accomplished in this direction, and the facts obtained are very valuable for the future guidance of naval architects. Circumstances may and do arise in the designing of war-ships which make it difficult, if not impossible, to associate requisite qualities with the long still-water period which theory and observation show to be favourable to steadiness. In such cases the use of bilge-keels is generally advantageous, and in ships of small size their effect may be most marked in limiting rolling. Merchant ships with periods varying greatly according to the nature and stowage of their cargoes may also derive benefit in all conditions from bilge-keels.

In making these lengthy references to bilge-keel resistance, it is not intended to pass by the fact that the form of the immersed part of a ship and the condition of her bottom very considerably affect the aggregate resistance. But all these conditions are included in the determination of the coefficients of resistance to rolling; and, moreover, the form of a ship is determined by the naval architect mainly with reference to its stability, carrying power, and propulsion,

not with reference to the increase of the resistance to rolling. The latter is a subordinate feature of the design, and is best effected by leaving the under-water form of the ship herself unaltered, and simply adding bilge-keels in cases where the size and inertia of the ship are such as to make them useful, and when the conditions of service of the ship, the sizes of the docks she has to enter, or other special circumstances permit their use.

Certain classes of ships present singular features considerably affecting their behaviour at sea. Vessels with projecting armour, like the American monitors, or the *Glatton* in the Royal Navy, or the *Devastation* class as they were originally designed, really possess in these projections virtual side-keels of great efficiency in adding to the resistance to rolling. The records of the behaviour of American monitors prove that the projections had a steadying effect. There was, however, the drawback that the alternate emersion and immersion of the armour shelf brought considerable shocks or blows upon the under side of the projecting armour, tending to shake and distress the fastenings of these singularly constructed vessels. Similar shocks were experienced in the *Devastation* when rolling in a seaway, although the vastly different construction of the armoured side prevented any injurious effects similar to those said to have been experienced in the American monitors. After several trials it was decided to "fill-in" the projection of the armour shelf in the *Devastation* in order to avoid the shocks; the reduction of the resistance being accepted when it had been ascertained beyond question that the vessel was steady and well behaved.

Low freeboard also, as previously explained, develops deck resistance by the immersion and emersion of the one or other side that accompanies moderate angles of rolling; and observations of the behaviour of monitors amongst waves have clearly shown that conditions similar to those of still-water obtain also for rolling amongst waves. In vessels of ordinary forms and good freeboard nothing similar to this deck resistance exists; and therefore in monitors the use of bilge-keels is not so necessary as it is in ordinary vessels.

The extinctive effect of free water contained in specially constructed chambers has been discussed on p. 182, when dealing with rolling in still water. Observations made at sea in the *Inflexible* and *Colossus* show that such water-chambers, even of moderate size, have a sensible steadying effect. In 1882, observations were made of the behaviour of the *Inflexible* off Alexandria when rolling in the trough of the sea, first with the water-chamber empty, and afterwards with different weights of water, varying from 40 tons to 120 tons. From an analysis of the records, it has been estimated that when the water-

chamber was about half full, the mean angle of roll was reduced by 20 to 25 per cent., as compared with the mean angle when the chamber was empty.* In 1886, a series of observations was made in the *Colossus* under various conditions of sea. It was found on one occasion that, with the *water-chamber empty*, the ship made 121 rolls in 10 minutes; the mean angle of oscillation was 11·7 degrees, the maximum 34·5 degrees, and the minimum 1·5 degrees. With 100 tons of water in the chamber, 125 rolls were made in 10 minutes; the mean angle rolled through was 10·4 degrees, the maximum was 25·5 degrees, and the minimum 1 degree. The general conclusion reached was that free water, properly adjusted in depth, had a considerable effect on the rolling, particularly during the heavier rolls, and that the rolling was a little quickened. Heavy shocks were delivered on the deck forming the top of the water-chamber, and also on the sides. No injury was done to the structure, but the shocks were disagreeable to those on board. Experience has shown also that in these broad, stiff ships the rolling is never excessive, although it is very common. For example, the *Inflexible*, on her passage across the Bay of Biscay in 1881, encountered heavy weather, including waves from 20 to 25 feet high, and nearly co-periodic with her rolling, yet she never rolled more than 10 or 11 degrees to the vertical. In view of this and similar experience in other vessels, the use of water-chambers has practically ceased in the Royal Navy.

Allusion has already been made (on p. 184) to the ingenious apparatus devised by Mr. Thornycroft for steadying ships in a sea-way by means of a movable weight, and to the results obtained with a yacht in rough water. It may be added that a pendulum of very short period practically determines the instantaneous direction of the normal to the effective wave slope, or virtual upright, when placed in a suitable position on the vessel. The motions of this pendulum, by means of most ingenious electrical arrangements, control the movements of the valves of a hydraulic ram, and secure the prompt and accurate movements of the weight in a manner that checks the tendency to roll due to the variations in the wave slope.

Rolling of Sailing Ships.—Up to this point attention has been confined to the rolling of ships among waves when no *sail is set*; it is now proposed to attempt an explanation of the still more difficult case where a ship under sail is exposed to the action of the wind and waves. This explanation must necessarily be brief, and the avoidance of mathematical language must make it even more imperfect than it would otherwise have been. The reader desirous of following out

* See Mr. Watts's paper in the *Transactions* of the Institution of Naval Architects for 1883.

the subject may refer to a paper contributed by the author to the *Transactions* of the Institution of Naval Architects for 1881, which is as full as the present state of our knowledge seems to permit, and which summarizes both what is known and what yet requires to be determined.

When a ship with sail set is rolling amongst waves, the forces operating upon her at each instant include all those which would be in operation if there were no sail set; and, in addition, the moment of the wind pressure on the sails, as well as the moment of the resistance of the air to the oscillatory motions of the sails. Our knowledge of the laws which govern the pressure of the wind on the sails is very imperfect; a brief *résumé* of that knowledge will be found in Chapter XII. Exact estimates cannot be made, therefore, for the moment of the wind pressure at any instant, even when the inclination of the masts to the vertical, the instantaneous angular velocity of the sails, and the direction and velocity of the wind are known. But, while this is true, certain general principles may be established. For example, as a ship rolls to windward the angular velocity of the sails increases the relative velocity of the wind past the sails, and this increase is greatest on the sail-area which is highest above water. Consequently, during this roll to windward, the moment of the pressure of the wind on the sails is increased, not merely by the greater relative velocity of the wind on the sails, but by the higher position of the centre of pressure. Conversely, during the roll to leeward at any instant the inclining moment of the wind pressure is decreased, and may be very largely decreased, by the angular velocity of the sails. Any attempt at exact investigation must take account, therefore, of these variations in the moment of the wind pressure.

Account must also be taken of the effect which the heaving motion produces upon the instantaneous righting moment which the ship can oppose to the inclining moment of the wind pressure. It has been shown (on p. 203) that a ship accompanying the motion of the waves, and heaving up and down as they pass under her, is subjected to accelerating forces which alternately tend to increase and decrease her "virtual weight." Now, the "instantaneous righting moment" is equal to the product of that virtual weight into the ordinate of the curve of stability corresponding to the instantaneous inclination of the masts to the normal to the effective wave slope. An illustration of this statement is given in Fig. 95. NN_1 shows the instantaneous direction of the normal (that is, the "virtual upright"). The masts are inclined to the normal at an angle of 37 degrees. The instantaneous righting moment equals the product of the "virtual weight" (allowing for heaving) into the arm of the righting lever

measured on the curve of stability for 37 degrees inclination. When the ship floats on the upper half of the waves her virtual weight is less than the true weight, and may be as much as 20 per cent. less. Consequently her instantaneous righting moment on the upper half of the waves is correspondingly decreased. And since the force of the wind is not similarly affected by the wave motion, it must during this time have a greater inclining effect upon the vessel than the same force of the wind would have in still water. It is a matter of common observation, which the foregoing remarks may help to explain, that boats and small craft are most frequently capsized when floating on wave crests. Of course, on the lower half of the waves, from mid-height to hollow, the virtual weights and instantaneous righting moments are greater than the corresponding values in still water.

Fig. 95 also serves to illustrate another point of importance, viz. that on the supposition that the wind acts horizontally, the moment of the wind pressure must be estimated in terms of the inclination of the masts to the vertical at each instant. Whereas, in consequence

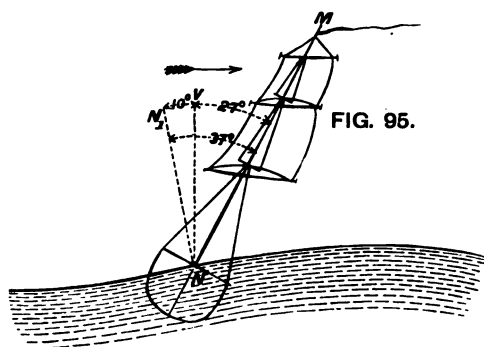

of the variations in the direction of fluid pressure, the stability or instability of the ship must be estimated by the inclination of the masts to the "virtual upright" NN_1 . In Fig. 95 NV is the vertical; the masts are inclined 27 degrees to it, but the wave slope adds 10 degrees to this inclina-

tion, and makes the angle by which safety or danger of capsizing is to be reckoned 37 degrees. Remembering what has been said in Chapter V. of the slopes of waves, it is desirable, when considering the sufficiency of the range of the curve of stability for any vessel, to regard it as abridged by 8 or 10 degrees in order to allow for the influence of wave slope upon the virtual inclination to the position of instantaneous equilibrium.

A ship with sail power, besides having provision made for resisting the heave of the sea, like a mastless ship, must be capable of resisting the heeling action of a steady force of wind continually applied, as well as the impulsive action of gusts and squalls. For all these reasons a rigged ship requires a greater range of stability than a vessel of the mastless type, and a glance at the curves of the typical ships in Fig. 60 will show that in all the types of rigged

war-ships therein represented, except the ill-fated *Captain*, this condition was complied with. In her case, however, the range of stability was very moderate: her initial stability not great, and her sail-spread large for an ironclad, all of which causes contributed to her capsizing. Without discussing the circumstances further, it may be interesting to make use of the ship for purposes of illustration, since we have very full published accounts of her qualities.

Suppose the *Captain*, with no sail set, to have floated on a wave 400 feet long and 22 feet high, having a maximum surface slope of about 10 degrees. The total range of stability for the ship (see curve 10 in Fig. 60) being 54 degrees, if the allowance of ten degrees be made for wave slope, there will remain 44 degrees, measuring the inclination to the vertical, which the ship would have to reach before she became unstable. Under the assumed conditions with sails furled, there would have been little or no risk of her reaching such an inclination, the *Captain* having proved herself to be a well-behaved ship in a seaway.

Next, take the case where sail is set, and the ship is acted upon by a *steady pressure of wind* which in still water would keep her at a steady angle of heel, say, of 10 degrees; this is within the truth, as it appears from the official reports that, on the day before she was lost, the *Captain* heeled from 10 to 14 degrees under canvas. We have already discussed the case where the *Captain* is sailing at a steady heel of 10 degrees in still water, and Fig. 76, p. 188, illustrates it. CD is the "wind curve," indicating the inclining effect of the wind on the sails for different angles of heel; and if by any means the vessel, which has been sailing at a heel of 10 degrees, is carried over to a greater inclination, the wind will follow, and always absorb that part of the area OCDD₁O of the curve of stability lying between the line CD and the axis of abscissæ (or "base-line") OD₁. It will be observed that the wind curve cuts the curve of stability at an inclination of 47 degrees, marked by the ordinate DD₁; so that the same force of wind that will steadily heel the ship 10 degrees will also hold her at 47 degrees, where she will be on the verge of capsizing. The effective range of the curve of stability, excluding the part absorbed by the steady force of wind, is therefore about 37 degrees only, that being the limit of inclination to the vertical which the ship can reach without being blown over when floating at mid-height on the wave. The decrease of 17 degrees from the total range, thus shown to be requisite to provide for the steady action of the wind, is a very serious matter. Apart from gusts and squalls, there would still be a good provision for safety, taking into account the steadiness of the ship; but even ships reputed steady occasionally roll as much as this, and if the *Captain* had reached a

position 10 degrees beyond that indicated in Fig. 95, she would have been on the point of capsizing. With steeper waves having a greater slope, the capsizing point would be sooner reached. In Mr. Childers' minute on the loss of the *Captain* (pp. 56 and 57) will be found similar illustrations to the foregoing, only on waves of very exceptional steepness, 200 feet long, 23 feet high, and having a maximum slope of 20 degrees; then, supposing the *Captain* to be subjected to a steady wind capable of inclining her 8 degrees in still water, it is estimated that only 21 degrees' inclination to the vertical would suffice to bring her to the verge of capsizing. Reverting to Fig. 76, and taking the case of the *Monarch* exposed to a force of wind equal to that assumed to act on the *Captain*, it will be seen that, after providing for the steady action of the wind, there remains an available range (KW) of over 55 degrees, instead of 37 degrees, as in the *Captain* under identical circumstances. From these two cases it will be evident that good range in the curve of stability is of the highest importance in rigged ships.

The greatest danger of capsizing results, not from the action of a steady force of wind, but from that of gusts and squalls which may strike the sails of a ship, upon which considerable rolling motion has been impressed previously by the action of the wind or waves. In Chapter IV. we have discussed the action of such gusts of wind upon sailing ships rolling in still water; similar but much more complicated conditions hold when a ship rolling among waves is caught by a squall at the extreme of a roll to windward. Various attempts have been made to deal with this difficult problem, and to enable the naval architect to form an opinion as to the ranges of stability sufficient in various classes of rigged ships. None of these attempts can be regarded as entirely successful, nor does the nature of the case permit of its solution by exact scientific investigation. Before such an investigation can be begun certain preliminary assumptions must be made: as to the sail-spread that shall be associated with a certain force of wind, the character of the waves amongst which the ship is placed, the inclination of the masts and their angular velocity at some instant, and the force of the squall as well as the position of the ship when struck. In short, some combination of circumstances has to be assumed as the worst likely to occur, in order that an opinion may be formed as to the probability of the ship capsizing or not. From this brief statement of the case, and bearing in mind what was said above as to the imperfect knowledge we possess of the laws governing wind pressure, it will be obvious that science has not yet enabled us to discuss with certainty the behaviour of sailing ships when rolling in a seaway. The naval architect has, therefore, to resort to experience in order to appreciate fairly the influence

of seamanship and the relative manageability of ships and sails of different sizes. Having before him the curves of stability of sailing ships of various classes, and the records of their performances at sea, the designer can proceed with greater assurance in the determination of the stability and sail-spread which shall be deemed sufficient in a new ship. A good range and large area of the curve of stability undoubtedly denote conditions which are very favourable to the safety of a ship against capsizing. But, in practice, such favourable conditions cannot always be secured in association with other important qualities, and a comparatively moderate range and area of curves of stability have to be considered when the question arises whether or not sufficient stability has been provided. Under these circumstances experience, and the analysis of the qualities of ships which have proved successful and safe, are of the greatest value.

Sailing ships of the mercantile marine and yachts usually have great range of stability when fully laden, for the reasons given in Chapter III. Rigged war-ships, on the other hand, frequently have moderate range of stability. So far as experience enables an opinion to be formed, it appears that in the smaller classes of seagoing war-ships with steam as well as sail power, a range of 60 to 70 degrees in the curve of stability suffices for safety; in the larger classes, above corvettes, the corresponding range is about 70 to 80 degrees. It will be understood that these values are based upon experience, and they probably provide a reasonable margin of safety. The provision of a large range of stability cannot be regarded, however, as a guarantee against accident apart from proper management and good seamanship. Examples are not wanting of the truth of this statement, and one of the most forcible is that of the merchant sailing ship *Stuart Hahnemann*. Her curve of stability is marked 8 in Fig. 63, p. 138; the angle of maximum stability exceeded 40 degrees, and the range exceeded 80 degrees. This vessel was thrown on her beam ends and sank; the court of inquiry found that she was well built and perfectly equipped, her loss being attributed to the too long continued use of a heavy press of sail, so that when the wind increased the sail could not be taken in.

Although it is impossible in the present state of knowledge to predict the worst possible combination of circumstances to which a sailing ship may be liable, it is possible to trace her behaviour, with fair approximation to accuracy, when a certain set of conditions has been selected. This can be done by means of an adaptation of the process of graphic integration to which reference was previously made. An example of the results obtained in this manner is given in Fig. 96. The general construction resembles that described for

Fig. 94. Measurements along the base-line represent *time*. Ordinates of the curve of "wave slope" represent the slope of the effective wave surface to the horizon at the corresponding time. At the instant

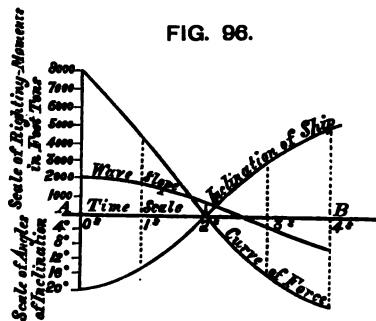

from which time is counted, the ship is assumed to have her masts inclined 20 degrees to the windward side of the vertical, to float at the mid-height of waves having a maximum slope of 9 degrees, and to have no angular motion. Her instantaneous inclination to the wave normal is therefore 29 degrees. It is then supposed that she is struck by a squall of wind, having such

a force as would hold her at a steady heel of 10 degrees in still water. This suddenly applied wind pressure follows her up as she rolls away to leeward, and at any instant the process of graphic integration takes account of the following forces as acting upon her: (1) The moment of wind pressure on the sails, corrected for the angular velocity (as described on p. 259); (2) the moment of the resistance offered by the water to the motion of the ship; (3) the instantaneous righting moment, corrected for heaving. The resultant of these three moments at any instant appears as the ordinate of the "curve of force" in Fig. 96; and the ordinate for the same instant of the curve of inclination shows the inclination of the masts to the vertical. Under these assumptions the vessel, which started from 20 degrees to windward, is driven over by the squall to 24 degrees to the leeward side of the vertical. If allowance were not made for the reduction in moment of wind pressure due to the motion of the sails away from the wind, then, starting from the same inclination to windward, the squall would drive the vessel over to 34 degrees to leeward. Further, were the effect of the fluid resistance neglected, the angle reached to leeward of the vertical would be 45 degrees. These figures are suggestive if not strictly accurate. They show how impossible it is to pronounce upon the maximum rolling of a ship without taking account of all the circumstances which may influence that behaviour.

Finally, on this part of the subject, reference must be made to the steadying effect which sail exercises upon a ship. This effect is a matter of common observation, and may be very simply explained. If a ship with sail set were rolling in a calm, the air would oppose great resistance to the oscillatory movement of the sails, and the rolling would be rapidly extinguished; this case is parallel to that described for water resistance in Chapter IV. When a ship is set

rolling by the action of the sea, while the wind blows uniformly, it is difficult to estimate separately the effects of wind pressure and the air resistance to rolling. But when squalls or gusts of wind act intermittently on a vessel, the influence of air resistance may become most important. Suppose, for example, the wind to lull when a ship has reached her extreme roll to leeward; then, on the return roll to windward, both air resistance and water resistance are tending to check the motion and lessen the extreme angle of roll to windward. So that if the squall strikes her again when the ship is at the extreme of the roll to windward, it finds the ship much less inclined to the vertical than she would be if air resistance were not operative. The following lurch to leeward would consequently be much less heavy.

Pitching and 'Scending.—The longitudinal oscillations of pitching and 'scending experienced by ships among waves must be briefly considered before concluding this chapter. In still water these longitudinal oscillations do not occur under the conditions of actual service; and it is difficult, even for experimental purposes, to establish such oscillations, because of the great longitudinal stability of ships. On this account we have little definite information respecting still-water periods for pitching, or the "coefficients of resistance" for longitudinal oscillations. One or two small ships of shallow draught and full form have been experimented with, the period of longitudinal oscillation having been found to have been about three-fourths the period of transverse oscillation. Other observations made at sea indicate that in many cases the period of pitching oscillations lies between one-half and two-thirds the period for rolling. In some cases it may fall as low as one-third the period for rolling, and in the Russian circular ships the two periods must be nearly equal.

The formula for the period of *unresisted* pitching may be expressed in the same form as that given on p. 154 for the period of unresisted rolling. Only the height m must be made equal to the height of the longitudinal metacentre above the centre of gravity; and the radius of gyration k must be estimated by multiplying each element of weight by the square of its distance from the transverse axis passing through the centre of gravity. It may be taken for granted that, as a rule, the effect upon the period of the great height of the longitudinal metacentre above the centre of gravity of a ship more than counterbalances the effect of the increased moment of inertia for longitudinal oscillations; whence it follows that the period for pitching is usually considerably less than that for rolling. Calculations for the period of unresisted pitching have been made in a few instances, but they have little practical importance.

The existence of waves supplies a disturbing force capable of

setting up longitudinal oscillations; this is a matter of fact, and it is easily accounted for. Suppose a ship to be placed bow-on to an advancing wave; its slope will at the outset rise upon the foremost part of the ship above the water-level in still water; and perhaps simultaneously at the after part of the ship the wave profile may fall below the still-water level. The obvious tendency of the bow will be to rise under the action of the surplus buoyancy at that part, the stern falling relatively; that is to say, a 'scending motion will be established, and its initial rate will depend upon the still-water period for longitudinal oscillations. After the wave-crest has passed the bow of the ship, supposing for the instant that the wave is long as compared with the length of the ship, there will probably be a reversal of the conditions. The wave profile on the back slope of the wave would probably fall below the still-water load-line at the bow, and this excess of weight over buoyancy would tend to check 'scending and cause pitching to begin. The motion thus created by the passage of the first wave would of course be modified by the passage of succeeding waves in the series; and in the end there would probably be established a certain phase of pitching and 'scending oscillations, corresponding in character to the phases of rolling described above, and largely influenced by the ratio of the apparent wave period to the natural period for still-water longitudinal oscillations.

This is the simplest case that can be chosen. It by no means represents all the conditions of the problem; but it shows how the existence of waves and their passage past a ship lead to disturbances of the conditions of equilibrium existing in still water, and to the creation of accelerating forces due to the excess or defect of buoyancy. No account has here been taken of the variations in the direction and magnitude of the fluid pressure at different parts of the wave; although these variations would undoubtedly produce some modification in the behaviour of the ship, the modification would not be likely to change the *character* of the motion, with which alone we are at present concerned.

This illustration also shows that the following are the chief causes influencing the pitching and 'scending of ships: (1) the relative lengths of the waves and the ships; (2) the relation between the natural period (for longitudinal oscillations) of the ship and the apparent period of the waves, this apparent period being influenced by the course and speed of the ship in the manner previously explained; (3) the form of the wave profile, *i.e.* its steepness; (4) the form of the ship, especially near the bow and stern, in the neighbourhood of the still-water load-line, this form being influential in determining the amounts of the excesses or defects of buoyancy corresponding to the departure of the wave profile from coincidence

with that line; (5) the longitudinal distribution of the weights, determining the moment of inertia. In addition, fluid resistance exercises a most important influence in limiting the range of the oscillations. This resistance is governed by the form of the ship, and particularly by that of the extremities, where parts lying above the still-water load-line are immersed more or less as the ship pitches and 'scends, and therefore contribute to the resistance.

This summary requires but few comments. It is obvious that, when the length of a ship is great as compared with the wave length, there is no probability of extensive pitching motions being produced. The *Great Eastern*, for example, with her length of 680 feet, could span from crest to crest even on the very large Atlantic storm waves observed by Dr. Scoresby; and on storm waves of common occurrence she might be floated simultaneously on three of them. Even less imposing structures, such as the largest ships of the Royal Navy, with lengths of 300 to 400 feet, are long as compared with ordinary storm waves, and therefore are not likely, as a rule, to accumulate large angles of pitching—a conclusion borne out by experience. Small vessels may, of course, fall in with waves which are long relatively to their own lengths; but in such cases it is a common observation that the vessels "float like ducks on the water"—that is to say, their natural periods for longitudinal oscillations are so small as compared with the wave period that they can very closely accompany the motions of those parts of the wave slope upon which they float. In fact, their condition furnishes a parallel to the case of the little raft in Fig. 83, except that the raft follows the upper surface of the wave, whereas the ship, stretching over a considerable length on the wave, and penetrating to some depth in it, does not follow the upper surface, but, as it were, averages the slope of a portion of a subsurface corresponding to her own length.

According to theory, the case of pitching is best dealt with in a manner similar to that adopted for rolling motions. The ship is supposed at every instant to have a tendency to move towards an instantaneous position of equilibrium which is a normal to her "effective wave slope"; but in the determination of this effective slope for longitudinal oscillations still greater difficulties are encountered than in the similar problem for rolling. One thing, however, is evident, even in the case where the length of the wave is great as compared with that of the ship, viz. that the steepness of the effective slope will be much less than the maximum slope of the upper surface, both because of the length along the wave which the ship occupies and of the depth to which she is immersed in it. Supposing her to be in the worst position, with the middle of her length at the steepest inclination of the wave, the slope of the surface to the horizon, at

the places occupied by the bow and stern, will be much less than the maximum slope ; and, further, as remarked previously, all subsurface trochoids in the wave are less steep than the upper surface. The effective slope has to be the resultant of these varying conditions, and must therefore be much less steep than the maximum surface slope. But even accepting this conclusion, and assuming an effective slope, no practical deductions of importance have yet been drawn from this method of viewing the question, beyond those obtained from general considerations, and stated in the preceding summary.

It has been asserted that in large ships extreme pitching is not likely to occur ; but it must be noted that even moderate angles of pitching lead to very considerable linear motions at the extremities of a long ship. For example, in the trials off Berehaven with the *Devastation*, *Agin-court*, and *Sultan*, it is reported that the *Sultan* on one occasion pitched so that the bow appeared buried very deeply in the wave, and observers on the deck of the *Devastation* could not determine whether the sea broke over the forecastle, which is some 30 feet above water when the ship is at rest in still water. Very similar remarks were made on another occasion respecting the *Agin-court*. For each degree of inclination from the upright, however, a point on the bow of the *Agin-court* would move vertically nearly 4 feet, and one on the bow of the *Sultan* about 3 feet ; so that very moderate angles of inclination *in still water* would suffice to bring the forecastle deck close to the water-level. Amongst waves, with their varying slopes into which the bow of a ship plunges, still more moderate inclinations might produce the same apparent effect. For example, the *Devastation* and *Agin-court* were tried steaming head-on to waves from 400 to 650 feet long and from 20 to 26 feet high, the speed of the ships being about 7 knots per hour. The periods of these waves varied from 9 to 11 seconds ; their maximum slopes, from $7\frac{1}{2}$ to 9 degrees. Allowing for the speed of the ships, the apparent periods of the waves varied from 7 to 9 seconds, giving apparent half-periods which probably approximated to equality with the natural period (for a single oscillation longitudinally) of the ships. It was a case, therefore, where the conditions were conducive to heavy pitching, and the results of the observations are interesting. The total arcs of oscillation for the *Devastation* were, on an average, 8 degrees only, that is, about 4 degrees on either side of the upright, or about one-half the maximum slope of the surface of the waves ; the maximum arc of oscillation was rather less than 12 degrees, about 6 degrees on either side of the upright, about three-fourths the maximum slope of the surface. The *Agin-court* pitched through rather smaller arcs than the *Devastation*, but, supposing her motion

to have reached the same maximum, the bow would have been immersed in still water about 20 feet below its normal draught; yet we are assured that a sea broke over the forecastle, which is some 10 feet higher above still water, a circumstance which is attributable to the bow having been plunged into an advancing wave-slope. These facts are mentioned in order to enforce the desirability of taking all possible precautions in estimating the extent of pitching; so many of the attendant circumstances tending to exaggerate the apparent motion, and to deceive the observer unless he has recourse to actual measurement of the angular motion.

From the foregoing remarks it will be evident that further progress in knowledge of the laws which govern pitching and 'scending must be largely dependent upon actual observations made at sea in a trustworthy manner. The Admiralty instructions provide for such observations when favourable opportunities present themselves; and this branch of the subject is one to which naval officers might devote attention with great advantage. As yet comparatively little information has been recorded; and of the published observations those made by M. Bertin are the most valuable.* With the aid of an ingeniously contrived instrument (described in Chapter VII.) M. Bertin obtained simultaneous automatic records of (1) the instantaneous inclination of the ship to the vertical as she pitched; and (2) the instantaneous position of the normal to the effective wave slope. His conclusions from a careful analysis of these observations may be briefly stated. With a ship head to wind and sea, among waves of sufficient length relatively to the ship to produce sensible pitching motion, and within certain limits of the ratio of speed of ship to speed of wave, all the ships for which observations were made followed the effective wave slope, just as the little raft in Fig. 83 follows the wave motion. Under these circumstances, as the speed was increased, but still fell within the assigned limit, the period for pitching was decreased, because this increase in speed shortened the apparent wave period; but the angle of pitching remained nearly constant. After this limit of speed had been surpassed the ships ceased to follow the effective wave slope, their pitching motions falling behind instead of keeping pace with the effective slope. At certain speeds the motion of the ship dropped one-fourth of the period behind that of the effective slope; and then the pitching was found to have the same amplitude as in the case first described. Further increase in speed and still further decrease in the apparent wave period, was found to produce much heavier pitching, and at

* They are to be found in "*Observations de roulis et de tangage faites avec Poscillographe double à bord de divers batiments*"; Cherbourg, 1878.

length led to the bows of the ships being buried so deeply in the wave slopes that the experiments were stopped.

When the ships were running before the sea, and by their motion lengthening the apparent period of the waves, the case was found to be much simpler, the ships practically following the effective wave slopes. Hence, from a review of the whole of his observations, M. Bertin concluded that the best means of reducing pitching, in the critical case where a ship is driven head to sea, is to make her natural period of pitching as short as possible, by concentrating weights amidships, and reducing the moment of inertia. This conclusion agrees with the recommendations made by experienced seamen. A commanding officer can obviously exercise considerable control over the pitching and 'scending motions of a ship by means of variations in speed and course relatively to the waves. The actual period observed for pitching motions will vary considerably for the same ship under different circumstances, and usually differ considerably from the still-water period for longitudinal oscillations. Most commonly, so far as can be seen at present, the observed periods of pitching closely agree with the apparent periods of the waves which are large enough to produce considerable pitching motions.

The longitudinal distribution of the weights in a war-ship has to be regulated by other considerations than those mentioned above. It often happens that, to increase the offensive powers, heavy weights of guns, or armoured batteries, have to be carried near the extremities, thus adding to the moment of inertia, slowing the period of pitching, and rendering it probable that pitching oscillations will be more sustained, even if they are not made more extensive. All that can be done, in most cases, is to minimize the stowage of weights at the extremities as far as possible. Guns, anchors, or other relatively small weights may be transported from the extremities to some position more nearly amidships, when the vessel is making a voyage: these temporary changes are, of course, the work of the commanding officer, and not of the designer. In merchant ships much more may be done towards securing a longitudinal distribution of the cargo which favours moderate pitching, if proper care is taken in its stowage. Heavy weights, as a matter of common experience, should be kept out of the extremities; and where this simple rule is ignored extensive pitching and unnecessarily severe longitudinal straining have to be expected.

Fluid resistance is known to play an important part, as already stated, in limiting the range of pitching oscillations; but the naval architect has not the same control over this feature as he possesses in connection with rolling motions. It would be difficult to fit any

appendages equivalent to bilge-keels in order to increase the resistance to longitudinal oscillations, although something may be done in this direction; and the under-water forms of ships are settled mainly with reference to their efficient propulsion, the effects of form on pitching usually occupying a subordinate place. Attempts have been made, however, to improve the forms of the bows of ships in order to lessen pitching; and very diverse opinions have been expressed as to the best form that can be adopted. Many persons are in favour of V-shaped or "flaring" cross-sections; the out-of-water parts having a large volume as compared with the immersed part lying beneath them. Others have strongly objected to flaring bows, and have introduced U-shaped cross-sections, with the view of reducing pitching, as well as of reducing the excess of weight over buoyancy at the bow. The advocates of the U-shaped sections consider that "the bluff vertical sections encounter greater upward resistance than the V-shaped sections when the ship tends to plunge down through the water, and receive a greater lifting effect when the sea tends to rise up under the ship."* The adoption of pronounced U-shaped sections for the bow has not become general, nor does it appear likely to do so, other considerations leading most naval architects to prefer finer under-water forms; but the use of strongly flaring sections above water is now less common than it was formerly, and naval architects agree that they are undesirable except in special cases.

Vessels of low freeboard are subjected to deck resistance when pitching among waves; and the *Devastation* furnishes an excellent example of this action. When on trial off the Irish coast, and steaming head to sea at moderate speeds, waves broke over the fore part of the deck, as it was anticipated they would do under these circumstances, the fittings on this deck having been designed to exclude from the interior water lodging upon it. An eye-witness, describing her motion, says, "It invariably happened that the seas broke upon her during the upward journey of the bow; and there is no doubt that to this fact her moderate pitching was mainly due, as the weight of water on the fore-castle deck, during the short time it remained there, acted as a retarding force, preventing the bow from lifting as high as it otherwise would, and this, of course, limited the succeeding pitch, and so on." In American monitors, with their exceptionally small freeboard, this kind of action would be even more effective, were it not for the

* *Naval Science*, vol. iv. p. 55. The reader may also consult on this subject a paper, by the late Dr. Woolley, "On the Bows of the *Helicon* and *Salamis*," in vol. vii. of the *Transactions* of the Institution of Naval Architects.

fact, that their natural periods for pitching oscillations are probably so small as to make them capable of accompanying very closely the motions of such waves as would otherwise produce considerable pitching. Mr. Fox (assistant secretary of the United States navy), reporting on the behaviour of the *Miantonomoh*, head to sea in a heavy Atlantic storm, said, "She takes over about 4 feet of solid water, which is broken up as it sweeps along the deck, and after reaching the turret is too much spent to prevent firing the guns directly ahead." This confirms the opinion that these vessels move so quickly as to very nearly accompany the wave slope; their actual arcs of oscillation in pitching being considerable. But these are cases of comparatively unfrequent occurrence, and are interesting chiefly as instances of the effect of fluid resistance in limiting the pitching motions of ships which immerse or emerge their decks. In ordinary ships the decks are much higher, and the longitudinal oscillations rarely acquire such a magnitude as to immerse the decks considerably.

Various proposals have been made for the purpose of increasing resistance to pitching. For instance, it has been suggested to fit horizontal side-keels near the extremities, or to broaden out the keel proper at those parts. At the bows of many armoured ships external supports are fitted to the projecting ram-bows; and these supports act as side-keels, which give increased resistance to pitching. The spur-bows themselves, prolonged under water as they are, also tend to reduce pitching by increasing resistance; and in the French navy, where this form of bow has been largely adopted for unarmoured as well as for armoured ships, it is said that a sensible reduction in pitching has resulted. French naval architects, while favouring a form of bow which reaches forward for a considerable distance under water, have often preferred to make the stem fall aft considerably above water; their intention in the latter particular being to reduce the weight above water at the extremity at the same time that they either increased the buoyancy by the spur-bow or "fined" the underwater form to facilitate propulsion. In recent French practice this form of bow has been abandoned, in consequence of its unsuitability for high speeds under steam.

In ships of ordinary form the maximum amplitude of rolling largely exceeds the corresponding maximum for pitching. M. Bertin considers that a fair ratio for these maxima is one (pitching) to six (rolling). We are not in possession of sufficient *data* to verify this estimate; but of the fact just stated there can be no doubt. Exceptions to this rule are to be found in the Russian circular ironclads and the *Livadia*. As the result of observations made on the latter in the Bay of Biscay, it appears that when placed

head to sea she pitched through somewhat larger arcs than those she rolled through when broadside on to the waves. This departure from ordinary conditions is noteworthy.

Heaving Oscillations.—In addition to the transverse and longitudinal oscillations above described, a ship floating amongst waves has impressed upon her more or less considerable vertical oscillations, “heaving” up and down as waves pass her. Taking the extreme case of the small raft in Fig. 83, p. 202, it will be seen that her centre of gravity performs vertical oscillations of which the amplitude equals the wave height, and the period is the wave period. This is termed “passive heaving.” A ship of large dimensions relatively to the waves obviously would not perform such large vertical oscillations. The extent of these vertical movements would depend upon her position relatively to the waves, her course and speed as affecting the apparent period of the waves, her natural period for “dipping” oscillations (see p. 162), the form of the effective wave slope, and the under-water form of the ship as influencing the fluid resistance to dipping. From the remarks made above, it will be seen that the vertical and horizontal extension of the ship in the wave structure have much influence upon the effective wave slope, whatever may be her position relatively to the waves. It has been suggested that the movement of the centre of gravity of the ship in passive heaving may be considered as similar to that of a particle in the wave lying on the trochoidal surface passing through her centre of buoyancy, when the ship is broadside on to waves. For the other extreme position, end-on to the waves, it has been proposed to take the mean of the vertical motions in the effective wave slope which she covers as an approximate measure. But it has been remarked, when dealing with longitudinal oscillations, that this latter assumption has little practical value.

Speaking generally, it may be said that the vertical oscillations of a ship result from the operation of excesses or defects of buoyancy due primarily to the passage of the waves and their trochoidal forms, but accentuated in many cases by the transverse and longitudinal oscillations of the ship, and by the dipping oscillations accompanying these oscillations. Heaving motions are favourable to safety and sea-worthiness, since they make it less probable that waves will break on board. A ship so small as to practically accompany the vertical component of the wave-motion—riding “like a duck”—makes good weather. When ships are beam-on to the sea and roll but little, heaving motions of considerable extent may take place, and amongst large waves these motions may be nearly as great as those of surface particles.

When ships are end-on to waves, although passive heaving may

have a small amplitude, the effect of dipping oscillations may be considerable when the natural period for dipping approximates to the apparent period of the waves. Pitching and 'scending oscillations may accompany the vertical movement of the centre of gravity of the ship. As this case has an important bearing on the longitudinal bending moments experienced by ships among waves, it may be desirable to examine it briefly.*

Suppose a ship to be end-on to waves having a length equal to her own, and for simplicity assume her to be "box-shaped"—that is, a rectangular parallelepipedon. Then one complete wave-profile would always be traced on the side of the vessel, the displacement would remain constant, and, although pitching and 'scending motions might be established by the passage of waves, the centre of gravity would have no vertical motion impressed upon it, if the longitudinal oscillations are considered to be unresisted. A ship of ordinary form with fine ends would be differently circumstanced. If she is astride a wave hollow (as in Fig. 114, p. 313), owing to the fineness of the ends, she will sink more deeply into the wave than when balanced on a wave crest (as in Fig. 113). Hence there will be reciprocating forces set up tending to produce vertical oscillations, which would naturally be performed in the natural period of dipping. If the reciprocating forces have a period synchronizing with the period of dipping, as may happen owing to certain relations of speed of waves and speed of ship, then the vertical oscillations will go on increasing in amplitude until the action of the fluid resistance puts a limit upon their extent. When there is not such synchronism, the amplitude of the vertical oscillations is not nearly so great. The case is parallel to that described for rolling on p. 235.

Attempts have been made to deal with this matter quantitatively, on the basis of certain assumptions for the laws of fluid resistance, for the periods of dipping oscillations, and for the variations of pressure at different depths in the wave structure. The results are necessarily open to correction by means of experiments on resistance and dipping, but they are of great interest. They indicate that in ships of large dimensions the effect of a succession of synchronizing impulses may produce considerable vertical oscillations of the centre of gravity. The alterations in the immersion or emersion of the ship from the positions corresponding to statical equilibrium may amount to 7 or 8 feet. The critical cases are obviously those where

* See on this subject a valuable and original investigation by Mr. T. C. Read in the *Transactions* of the Institution of

Naval Architects for 1890; and the remarks on longitudinal bending on p. 319.

the vessel is at its extreme of emersion on a wave crest and its extreme of immersion on a wave hollow.

In conclusion, it may be remarked that in the actual behaviour of ships at sea all these kinds of oscillation may be occurring simultaneously, and may mutually influence one another. Careful observations alone can decide upon their absolute values, and ordinarily rolling motions alone are considered worthy of observation.

CHAPTER VII.

METHODS OF OBSERVING THE ROLLING AND PITCHING MOTIONS
OF SHIPS.

ENOUGH has been said in previous pages to show how variable, and how liable to mislead an observer, are the conditions surrounding the behaviour of a ship at sea. The ship, herself in motion, is surrounded by water also in motion; and it is extremely difficult, by means of unaided personal observation, to determine even so apparently simple a matter as the position of the true vertical at any instant. To estimate correctly the angles through which a ship may be rolling or pitching, it is therefore necessary to bring apparatus of some kind into action; and in the use of such apparatus there are many sources of possible error which must be prevented from coming into operation. Upon the correctness of these observations we are greatly dependent, since deductions from theory are thus checked, and the extent to which they can be made a safe guide for the naval architect in designing new ships is ascertained. Numerous examples illustrating the substantial agreement of observation with the chief deductions from theory have been given in the previous chapter; but up to the present time the comparison has been mainly of a qualitative character, and before more exact results are obtained, it will be necessary to have compiled and collated much more exact and extensive records than are at present accessible.

The chief problem to be solved is this. What are the conditions of wave motion that will produce the maximum oscillation in a ship, of which the still-water period of oscillation as well as the coefficients of resistance are known; and what will be the range of that maximum oscillation? Or, it may be desirable to ascertain generally what extent of motion will be impressed upon a ship by a series of waves of certain assumed dimensions. Pure theory will not be likely to supply correct answers to these questions; but there is reason to believe that they may be dealt with satisfactorily by a combination

of the experimental and mathematical modes of investigation, such as the process of "graphic integration" described at p. 251. The development of that process and its establishment in general use as a means of predicting the behaviour of ships, demand an extensive comparison of the results obtained by its application with the recorded observations of the behaviour of ships. Such a comparison can obviously be of use only when the individual observations are free from errors and accompanied by full particulars of the conditions of wind and sea. Methods of observing correctly the lengths, heights, and periods of waves have been described in detail in Chapter V.; and it is now proposed to sketch the methods which have been adopted at various times for observing the rolling and pitching oscillations of ships.

Of these methods, the following are the most important:—

(1) The use of pendulums, with various forms of clinometers; these pendulums having periods of oscillation which are very short as compared with the periods of ships.

(2) The use of gyroscopic apparatus.

(3) The use of "batten" instruments, or alternatives.

(4) The use of automatic apparatus.

Taking these in the order they have been named, it may be well to glance at their chief features, and to indicate the probable correctness or otherwise of their records.

Pendulums, or clinometers, are the simplest instruments, but they are not trustworthy indicators of the angles of inclination attained by a ship when rolling in still water, and much less of those moved through by a ship rolling or pitching at sea. When a ship is held at a steady angle of heel (as shown by Fig. 34, p. 83), a pendulum suspended in her will hang vertically, no matter where its point of suspension may be placed, and will indicate the angle of heel correctly. The only force then acting upon the pendulum is its weight, *i.e.* the directive force of gravity, the line of action being vertical. But when, instead of being steadily inclined, the ship is made to oscillate in still water, she will turn about an axis, passing through or very near to the centre of gravity; hence every point not lying in the axis of rotation will be subjected to angular accelerations, similar to those which were described in Chapter IV. for a simple pendulum. Supposing the point of suspension of the clinometer to be either above or below the axis of rotation, it will be subjected to these accelerating forces, as well as to the directive force of gravity, and at each instant, instead of placing itself vertically, the clinometer, or pendulum, will tend to assume a position determined by the resultant of gravity and the accelerating force. If the period of the pendulum used is short as compared with the

period of the ship, the position towards which it tends to move will probably be reached very nearly at each instant. The case is, in fact, similar to that represented in Fig. 93, p. 240. If the length of the upper pendulum (AB) is supposed to represent the distance from the axis of rotation of the ship to the point of suspension of the pendulum which is intended to denote her inclinations, the clinometer pendulum may be represented by BC. As AB sways from side to side the point B is subjected to angular accelerations, and these must be compounded with gravity in order to determine the position which BC will assume; for obviously BC will no longer hang vertically. The angular accelerating force reaches its maximum when the extremity of an oscillation is reached, consequently it is at that position that the clinometer will depart furthest from the vertical position. In Fig. 93, suppose VAB to mark the extreme angle of inclination reached by the ship, and let AB be produced to D: then, to an observer on board, the angle CBD will represent the excess of the apparent inclination of the ship to the vertical above the true inclination.

It will be seen that the linear acceleration of the point of suspension B depends upon its distance from the axis of rotation A in Fig. 93. If B coincides with the axis of rotation, it is subjected to no accelerating forces, and a quick-moving pendulum hung very near to the height of the centre of gravity of a ship rolling in still water will, therefore, hang vertically, or nearly so, during the motion, indicating with very close approximation the true angles of inclination. Hence this valuable practical rule: when a ship is rolling in still water, if a pendulum is used to note the angles of inclination, it should be hung at or near to the height of the centre of gravity of the ship; for if hung above that position it will indicate greater angles, and if hung below will indicate less angles, than are really rolled through; the error of the indications increasing with the distance of the point of suspension from the axis of rotation and the rapidity of the rolling motion of the ship.

The errors of pendulum indications for still-water oscillations may be approximately estimated from the following formula, proposed by the late Mr. Froude:—

Let α = true angle of inclination reached by the ship;

β = apparent angle of inclination indicated by the pendulum;

T = period of oscillation (in seconds) for the ship;

h = the distance (in feet) of the point of suspension of the pendulum above the centre of gravity of the ship—

$$\text{Then } \alpha = \frac{3.27T^2}{3.27T^2 + h} \times \beta.$$

If, instead of 3.27, we write $3\frac{1}{2}$, this takes the approximate form—

$$a = \frac{10T^2}{10T^2 + 3h} \times \beta,$$

which will be sufficiently near for practical purposes. In the case where the point of suspension is at a distance h below the centre of gravity, the corresponding approximate formula is—

$$a = \frac{10T^2}{10T^2 - 3h} \times \beta.$$

Take one or two illustrative examples. For the *Prince Consort* $T = 5\frac{1}{2}$ seconds; and h may be taken as 20 feet, if the pendulum were placed on the bridge—

$$\begin{aligned} \text{Then } \frac{a}{\beta} &= \frac{10T^2}{10T^2 + 3h} = \frac{300}{300 + 60} = \frac{5}{6} \\ \text{or } a &= \frac{5}{6}\beta; \end{aligned}$$

and the pendulum indicates an excess above the true angle of heel of 20 per cent. In the *Devastation* a pendulum placed on the flying deck is about 25 feet above water; also $T = 6\frac{3}{4}$ seconds.

$$\begin{aligned} \text{Then } \frac{a}{\beta} &= \frac{10 \times (6\frac{3}{4})^2}{10 \times (6\frac{3}{4})^2 + 3 \times 25} = \frac{450}{450 + 75} = \frac{450}{525} = \frac{6}{7}; \\ a &= \frac{6}{7}\beta. \end{aligned}$$

Here the pendulum indications exaggerate the true angles of inclination by about 16 per cent.; notwithstanding the greater height of the point of suspension above the centre of gravity, the slower motion of the *Devastation* makes the error smaller than in the *Prince Consort*.

So much for the simple case of still-water oscillations. In the more complicated case of a ship oscillating amongst waves, the errors of pendulum observations are frequently still more exaggerated. The centre of gravity of the ship is then, as explained in the preceding chapter, subjected to the action of horizontal and vertical accelerating forces. If the pendulum were hung at the centre of gravity (G) of the ship, shown on a wave in Fig 83, p. 202, it would, therefore, no longer maintain a truly vertical position during the oscillations, but would assume at each instant a position determined by the resultant of the accelerating forces impressed upon it and of gravity. The direction of this resultant has been shown to coincide with that of the corresponding normal to the effective wave slope. Hence follows another useful practical rule. When a ship is rolling amongst waves,

a quick-moving pendulum suspended at or near to the height of the centre of gravity will place itself normal to the effective wave slope, and its indications will mark the successive inclinations of the masts of the ship to that normal, not their inclinations to the true vertical. This distinction is a very important one. For example, in an American monitor, supposing her to keep her deck very nearly parallel to the wave slope as she might do, if a pendulum were hung close to the height of the centre of gravity, it would indicate little or no rolling motion; whereas the monitor would really be reaching inclinations equal to the maximum wave slope on each side of the vertical. On the other hand, if a steady ship, such as the *Inconstant*, were amongst the same waves, a pendulum hung at the centre of gravity would indicate extreme angles of inclination far in excess of the true rolling; for if the ship remained practically upright during

FIG. 97.

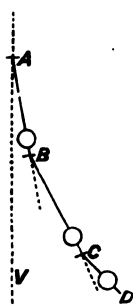

the passage of the waves, the pendulum would indicate angles of inclination nearly equal to the effective wave slope.

When hung at any other height than at that of the centre of gravity of a ship rolling amongst waves, the indications of a pendulum are still less to be trusted. Referring to Fig. 97, three pendulums are shown combined, viz. AB, to which hangs BC, and from this is suspended a third, CD. Supposing AB made to swing through a fixed range, it will represent the wave oscillation; then the motion of BC will represent the oscillations of a ship amongst the waves; and finally CD will represent the clinometer pendulum suspended at some point other than at the height of the centre of gravity of the ship. In view of what has been said above, it will be obvious that the motions of the pendulum BC will not be indicated correctly by the pendulum CD; yet this is a parallel case to that when a pendulum or clinometer is trusted to indicate the angles of inclination to the vertical of a ship rolling amongst waves.

For a ship rolling among waves there is clearly no fixed axis of rotation, and the problem to be solved in discussing the possible errors of indication in a quick-moving pendulum hung at various heights in a ship is one of great difficulty. It would be out of place to introduce this discussion here; but reference may be made to some interesting observations with pendulums made by officers of the French Navy. Admiral Bourgois made simultaneous observations of the rolling of the ironclad ship *Magenta*, in 1863, by correct batten observations of the horizon (such as are described hereafter) and by quick-moving pendulums hung in different vertical positions. In that ship he discovered that a quick-moving pendulum hung

nearly at the height of the centre of buoyancy indicated practically correct angles of inclination to the vertical when the ship reached her extreme roll. Captain Mottez also made some similar experiments in the frigate *Sybille* in 1865, when rolling heavily, and reached the following conclusions: that no possible point of suspension could be found where the indications of a pendulum were not influenced by the accelerating forces resulting from the rolling and heaving of the ship; but that the errors of indication were least when the pendulum was hung at about mid-draught. These results may not hold good in all cases, but they are of considerable practical interest, and may lead other observers to make similar experiments. It must always be an advantage to know where a pendulum may be placed in a ship so as to indicate with approximate correctness her angles of rolling, as circumstances may arise when only pendulum observations are possible.

Pendulums are commonly hung above water in ships, and under these circumstances their indications usually err in excess, and in some cases the error is proportionately very great, as the following examples will show. The figures are taken from published returns of rolling for her Majesty's ships:—

Ships.	Pendulum indications.	Correct angles.
	degrees.	degrees.
<i>Lord Warden</i>	11·4	9·1
<i>Minotaur</i>	6·1	3·8
”	8·2	4·3
<i>Bellerophon</i>	8·2	3·0

Many similar examples could be given, but they appear unnecessary; the correct angles stated in the table were observed in all cases with the accurate batten instruments which are now the service fitting.

The misleading character of pendulum observations has been for many years acknowledged; and they are no longer made in ships of the Royal Navy, except in special cases. When the horizon is obscured, or at night, batten observations cannot be made, while pendulum observations can; and it is ordered that under these circumstances the rolling indicated by the pendulums shall be noted. To enable the results so obtained to be afterwards corrected, simultaneous observations are made, when circumstances permit, of the indications of these same pendulums hung in the same positions, and of the indications of batten instruments.

Any other devices, such as spirit-levels or mercurial clinometers,

depending for their action on the directive force of gravity or statical conditions, are affected by the motion of a ship much as the pendulum has been shown to be affected. Suppose a spirit-level to be placed in a ship, at the height of the centre of gravity; in accordance with the principles previously explained, when its indications would lead an observer to think it exactly horizontal, it would really be parallel to the effective wave slope. Many persons who admit the faultiness of the pendulum are disposed to cling to the use of the level; but on reflection it will be seen that both instruments are open to similar objections. Moreover, the extreme sensitiveness and rapid motions of the spirit-level make it ill adapted for any observations in a seaway.

Many proposals have been made for mercurial clinometers, in the form of bent tubes, the mercury in both arms standing level when a ship is upright and at rest, while the difference in the heights of the column in the two arms indicates any angle of steady heel. It is supposed by the inventors that the corresponding difference in height in the two arms will also indicate, at any instant, the angle of inclination to the vertical of a ship rolling at sea. From the foregoing explanations it will be obvious that this is not true; but as so many persons have fallen into the same error, it may be well to confirm this statement by the result of actual observations. One of the best mercurial clinometers devised was tested in her Majesty's ships during 1886, by simultaneous observations of clinometers and batten instruments—the latter being accurate. In one ship it was found that when the true angle of roll was 16 degrees the clinometer showed 11 degrees; whereas in another observation in the same ship, made only a few minutes after the first, the clinometer indicated 16 degrees when the true inclination was 13 degrees. Taking the whole observations, 470 in number made in a period of 10 minutes, the mean angle of roll by clinometer was 9·8 degrees, and by batten 10·2 degrees. There was, therefore, a close, but accidental, agreement in the mean angle of roll measured by the clinometer and by battens. The clinometer varied widely from the truth, and had no constant rate of error, its indications being sometimes considerably above, and at others considerably below the true angle of roll.

Corresponding observations made in another ship gave the following results among others:—

Clinometer indications. degrees.	Correct angles. degrees.
2½	7
4½	7
8	2½
8	4
10	13
12	12

Mercurial clinometers are not so sensitive as spirit-levels, and are, in some respects, more convenient than pendulums; but they are not more trustworthy.

Several kinds of *gyroscopic instruments* have been devised for the purpose of measuring rolling and pitching motions, all of them being based upon the well-known principle—exemplified in the toy gyroscope—that a delicately balanced heavy-rimmed wheel spinning rapidly will maintain the plane of rotation in which it is set spinning, until its speed of rotation is considerably diminished. One of the earliest instruments of the kind is illustrated by Fig. 98. It was

FIG. 98.

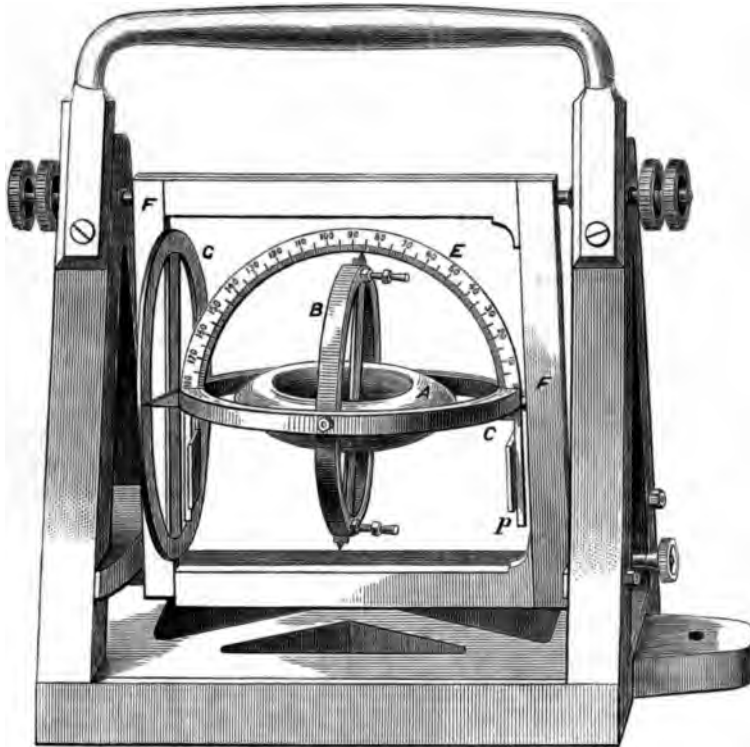

devised and tried at sea about thirty years ago by Professor Piazzi Smyth, and could be used to measure “yawing” motions as well as rolling and pitching.* It consists of a fly-wheel A, the axis of which forms a diameter of the gymbal-ring B; this is carried by a second gymbal-ring, C, the pivots of which rest on the frame F; and the

* See the description given by the inventor in vol. iv. of the *Transactions* of the Institution of Naval Architects, from which the drawing is taken.

whole is mounted in an outer frame, enabling it to be easily carried or placed in position. Suppose the pivots of the ring C to be placed athwartships in a ship, the instrument standing on the deck or on the table: then for transverse oscillations the line-of-centres of the pivots will remain parallel to the deck—that is to say, so far as rolling is concerned the ring C must move with the ship. But it is free to oscillate about its pivots as the ship pitches.

When the fly-wheel A is spinning rapidly and maintaining its plane of rotation, it is practically uninfluenced by the motions of the ship which so largely affect the pendulum; and as its axis is carried by the ring B, that ring also must maintain its position. This maintenance of position by B further involves the non-performance of any oscillations by C except in the *transverse* sense. In other words, neither A nor B changes the direction of its plane, while the ship rolls and pitches, so long as A spins rapidly; while C can accompany the rolling motion, but not the pitching motion. Hence the graduated semicircle E, shown fixed upon and across C, moves relatively to B as the ship rolls; and the pointer attached to the upper edge of B sweeps over an arc on the semicircle equal to the arc through which the ship is oscillating. On the left-hand side of the diagram there is shown a graduated circle G, which has its centre coincident with one of the pivots of C, and is *fixed* to the frame F. As the ship pitches, therefore, the frame F moves with her, and oscillates about the ring C, which is prevented from accompanying the pitching in the manner described. Pointers are attached to the under side of C, and the arcs they sweep over upon the graduated circle G indicate the arcs through which the ship pitches. By this ingenious arrangement the simultaneous rolling and pitching motions can be read off by observers with the greatest ease.

One point of disadvantage attaching to this as well as to all other gyroscopic instruments should be noted; viz. that there is no separate indication of the angles of inclination attained on either side of the vertical. When the wheel A is set spinning, if it were truly horizontal, then B would be vertical, and this disadvantage would disappear. But a ship in a seaway changes its position rapidly, and it is practically impossible to secure this condition of initial horizontality; hence the observer must be content to note the *total arcs* of oscillation. No doubt, in most cases, the rolling of a ship not under sail approaches equal inclinations on either side of the vertical, the roll to leeward being somewhat in excess of that to windward; but in a ship under sail the rolling takes place about an inclined position, and in any case it is a great advantage to be able to ascertain the extreme inclination on either side of the vertical.

Professor Smyth fully appreciated this defect of all gyroscopic

instruments, observing that they had "no power of determining "absolute inclination, or angular position with reference to horizon "or meridian"; but he was unacquainted with any other instrument which did not have its records affected by the accelerating forces due to the motion of the ship, and so preferred the gyroscopic clinometer. Now we have other means of measurement free from the objections belonging to pendulums or spirit-levels, and can therefore afford to dispense with the gyroscope.

It has been mentioned that the maintenance of the plane of rotation by a fly-wheel depends upon the maintenance of its speed; this is well illustrated in the common top, which droops as the speed decreases. The practical difficulties attending the use of these instruments arise, therefore, from the extreme care required in suspending the fly-wheels in order that friction or other causes may have the least effect in hindering free rotation, and in the difficulty of maintaining continuous rotation. The instrument shown in Fig. 98 is said to have been so well designed that, when once carefully adjusted, it did not require readjustment for some time; but from the few records of its use that have been published, it would appear that any single series of observations was limited to a very brief period. When a considerable time is occupied in making the observations, there is a danger of the gyroscopic action being somewhat interfered with by the loss of speed of rotation.*

On this point some interesting facts have been stated by the late Admiral Paris, of the French Navy, who produced a gyroscopic clinometer some years ago, which automatically accorded the rolling of a ship. The gyroscopic wheel in this instrument formed the body of a top, the lower end of the axis about which it spun being wrought to a sharp point, and resting on an agate bearing in order to diminish friction. To spin this top, a string was wound round the upper part of the axis, and drawn off gradually, giving a gradually accelerated motion of rotation. It was found that this top would revolve steadily on a support for about half an hour; nine minutes sufficed to degrade its revolutions from 23 per second to 12 per second; but this lower speed sufficed to make the top steady enough to be used for recording the motion of a ship in a seaway. The observations were usually extended over about ten minutes.

The automatic recording apparatus was extremely simple. As the ship rolled, the gyroscopic top maintained its axis in the same

* When the instrument illustrated in Fig. 98 was used to measure "yawing," it was placed with the pivots of the ring C in a vertical line; the frame lying on

its side instead of its bottom, and the wheel B being horizontal. The angles of "yawing" could then be read off on the graduated circle G.

direction as that in which it was set spinning, and upon the upper end of the axis a camel-hair pencil saturated with ink was fixed. A sheet of paper was made, by means of clockwork, to travel longitudinally over the pencil point, being curved in the transverse sense, so that the point should just touch the paper as it swayed to and fro. The paper, with the arrangements by which it was made to travel, being attached to the ship, rolled with her, while the axis of the top maintained its original direction; hence the pencil-point traced out on the paper a curve showing the inclinations of the ship at any instant on either side of the initial position of the pencil. The rate at which the clockwork propelled the sheet of paper was constant; consequently the period of oscillation of the ship, as well as the arc of oscillation, could be read off from the diagram traced. Admiral Paris appears to have endeavoured to set the axis of his top truly vertical before commencing to record the motion, in order that the diagram might show inclinations to the vertical as well as arcs of oscillation; but in doing this, he must have encountered considerable difficulties. We cannot further describe his ingenious arrangements, which are given in vol. viii. of the *Transactions* of the Institution of Naval Architects.

M. Normand has proposed an instrument for measuring rolling differing from the gyroscope in principle, but intended to effect a similar object, viz. the maintenance of an invariable plane, to which the motions of the ship could be referred. A spherical vessel is entirely filled with petroleum, and hung on double gymbal-rings like a compass. It contains a very light pendulum, situated at the centre of the sphere, and formed as a flat disc, carrying a pointer which stands at right angles to the disc. The inventor supposes that the fluid in the central parts of the sphere would have no angular motion set up in it by the reciprocating oscillations of the ship or the small oscillations of the sphere on its gymbal-rings, and that the pendulum would remain practically horizontal while the vessel rolled, its indicator being vertical. Much would obviously depend upon the position in the ship at which this instrument was placed. Supposing it to be at the centre of gravity, M. Normand's supposition might be nearly fulfilled, and the sphere with its contents would act like a common pendulum, its motions being governed by those of the effective wave slope, and keeping time with the wave period. Under these circumstances it is conceivable that the motions of the disc-pendulum might be small, and the motions of the ship might be fairly well indicated. But the use of any such instrument has never found general favour; in practice simpler methods suffice, and for more scientific research it appears preferable to have recourse to a different principle, hereafter to

be described, in order to secure an invariable vertical line of reference.*

Batten instruments afford the simplest correct means of observing the oscillations of ships; they can be employed whenever the horizon can be sighted. The line of sight from the eye of an observer standing on the deck of a ship to the distant horizon remains practically horizontal during the motion of the ship. Consequently, if a certain position be chosen at which the eye of the observer will always be placed, and when the ship is upright and at rest, the horizontal line passing through that point is determined and marked in some way; this horizontal line can be used as a line of reference when the ship is rolling or pitching, and the angle it makes at any instant with the line of sight will indicate the inclination of her masts to the vertical.

This principle may be applied in different ways; one of the most common, generally adopted in ships of the Royal Navy, is illustrated in Fig. 99. The point E on the middle line of the cross-section marks the position of the eye of the observer; and at equal distances

FIG. 99.

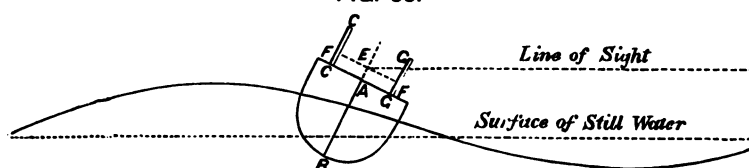

athwartships, two battens CC and GG are fixed perpendicularly to the deck, so that, when the ship is upright and at rest, these battens are vertical, and at that time the line FEF will be horizontal. This line may be termed the "zero-line"; and the points FF would be marked upon the battens, being at a height above the deck, exceeding that of the point E by an amount determined by the transverse curvature or "round" of the deck. Suppose the diagram to represent the case of a ship rolling among waves; when she has reached the extreme of an oscillation to starboard, EG marks the line of sight to the horizon, and the angle GEF measures the angle of inclination of the masts to the vertical. If the battens are placed longitudinally, instead of transversely, the angular extent of pitching may be similarly measured. The angles are usually read off on that side of the point of observation E towards which the vessel is inclined; rolls to starboard being measured, for example, on the starboard battens, rolls to port on the port battens. Sometimes the inclina-

* Drawings and descriptions of this instrument will be found in vol. vii. of the *Transactions* of the Institution of Naval Architects.

tions to both port and starboard are read off on one batten, above and below the zero. It is a great practical convenience to have the vertical battens graduated so that an observer can at once read off and note down the angles of inclination in degrees. This graduation is very simply effected when the positions of the battens relatively to E have been fixed, and the zero-line FEF determined. Once graduated, the battens can, of course, be removed when the observations are not in progress, and replaced in the same positions when required.

The zero-line on the battens having been fixed in the manner previously explained, the horizontal distance from the position where the eye of the observer will be placed to the vertical batten is measured; suppose this to be d feet, it will be indicated by EF in Figs. 99 and 100. Then, for any angle α , we have—

$$\left. \begin{array}{l} \text{Vertical height (FG) to be set off above} \\ \text{zero-line on batten} \end{array} \right\} = d \cdot \tan \alpha.$$

The value of $\tan \alpha$ being taken from a table, the product $d \tan \alpha$ can be found. For instance, suppose $d=20$ feet, and $\alpha=15$ degrees: $\tan \alpha=0.268$, and vertical distance (FG) to be set above zero-line will be $(20 \times 0.268) = 5.36$ feet.

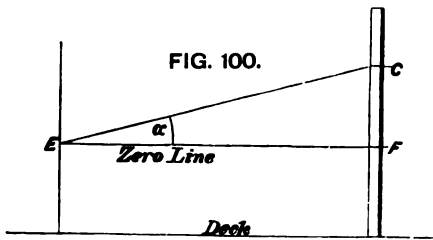

Another form of the batten instrument is shown in Fig. 101. AB is a straight-edged batten pivoted at C, and carried by a frame having

attached to it a semicircular graduated arc. Suppose that, when the ship is upright and at rest, the base of the instrument is so fixed that the pivoted bar, occupying the position AB, is

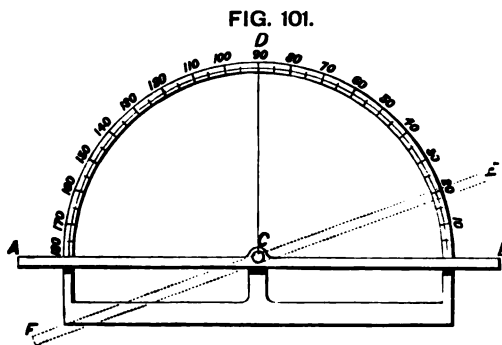

horizontal. Then the line ACB marks the zero-line to which angles of inclination may be referred. The instrument may, if desired, be set transversely when rolling motions are being observed; the observer looking along the edge of the pivoted batten will always keep it

pointed to the horizon, and its motions can be observed on the graduated arc. For example, suppose the position FE to have been

reached, then the angle ECB (a little over 20 degrees) will indicate the inclination of the masts of the ship to the vertical at that instant.*

Instead of looking lengthwise, and athwartships, along the edge of the batten when the instrument is set transversely, the observer may, if he prefers, stand before or abaft the instrument, and move the pivoted bar so as to keep its edge always parallel to the horizon; the angular motion of the bar indicated on the graduated arc will measure the inclination as before. To measure pitching, the instrument should be set longitudinally in the ship, the zero-line being adjusted as explained for rolling; and the observer will either look longitudinally along the edge of the batten, in order to keep it pointed to the horizon, or will stand and look athwartships, keeping the edge parallel to the horizon. In either case the angles of pitching may be read off from the graduated arc.

It will at once occur to the reader that the angular motions of such a pivoted bar might be readily made, by means of suitable mechanism attached to some point on the bar, to furnish an automatic record on a travelling sheet of paper moved at a uniform speed by clockwork. This has actually been done in some cases, a diagram being automatically traced, showing the inclinations of the ship throughout the period of observation.

The proper conduct of observations with common batten instruments requires at least two observers: one to note the extreme angles of inclination attained by the ship, a second to note the periods of successive rolls. In the Royal Navy a single series of observations would last ten minutes, and during that time one observer would have to note the extreme inclinations for from seventy to, perhaps, one hundred and fifty or two hundred single rolls, according to the class of ship and character of the waves. The other observer would, meanwhile, note the times of performing successive rolls, and the total number of rolls during the ten minutes. To facilitate the entry of the particulars, printed forms are issued to the ships of the Royal Navy. The dimensions and periods of the waves ought also to be observed simultaneously with the rolling or pitching; and this requires the attention of an independent set of observers, whose work should be conducted somewhat in the manner indicated in Chapter V. In large war-vessels with numerous complements it is easy to carry on such observations; in small vessels it is not always easy to provide for the working of the ship and to detail officers for observations of rolling and pitching. The most important observations, are, however, those made in large ships of new types.

* It will be evident that this instrument could also be used at night, when stars of known altitude were visible.

A very ingenious process for automatically making and recording horizon observations of rolling, by means of photography, has been devised by M. Huet of the French Navy, and successfully applied in several vessels. The apparatus consists of a camera fixed in the ship so that its axis is horizontal when the ship is upright. The field of the object lens is narrowed to a vertical slit, and a sheet of sensitive paper is made to travel parallel to the lens, by means of clockwork, at a uniform rate. On this sensitive paper a line is traced which would be in the same horizontal plane with the axis of the camera when the ship was upright, and this is taken as a line of reference. As the ship rolls the sensitive paper receives at each instant an impression of the sea and sky on the horizon; the colours being quite distinct; and their junction defining the instantaneous inclination of the ship to the vertical. Let d = the vertical distance of the junction of sea and sky shown on the paper at any instant, measured above or below the line of reference above named. Then, if f is the horizontal distance from the lens of the camera to the sensitive paper, and θ the angle of inclination of the ship to the vertical—

$$\tan \theta = \frac{d}{f}$$

is an equation determining the value of θ at every instant. The motion of the ship is, therefore, continuously recorded, and her inclinations at any time as well as her extreme angles of excursion can be ascertained. As an economizer of labour on the part of observers and an extension of the method of batten observations, this method is valuable. From specimens of the diagrams obtained on the sensitive paper which M. Huet has been good enough to furnish to the author, it also appears that the photographic records obtained are precise and easily interpreted. Independent observations of the wave phenomena accompanying rolling are necessary with this method, as well as with batten observations.

For all ordinary purposes batten observations of rolling and pitching, such as are made in the Royal Navy, suffice. They depend for their accuracy upon the care exercised by observers, and furnish the extreme inclinations attained by the ship, and the period of her oscillation. Although these may be associated with simultaneous observations of the waves, there is no continuous record of the ratio of the angle of inclination of the ship to the angle of wave slope. More complete information, such as is most valuable for scientific purposes, requires the use of automatic instruments, the records of which may be made continuously during prolonged periods. Such instruments require care both in their construction and management; but if they are based upon correct prin-

ciples, they can be, and have been, made capable of far surpassing the results obtained by the most careful personal observation. Both in France and in this country such instruments have been made and used. M. Bertin, of Cherbourg, and the late Mr. W. Froude independently constructed instruments for this purpose, based upon very similar principles. That of Mr. Froude has been used on board the *Greyhound*, *Perseus*, *Devastation*, and *Inflexible* with great success, and a description of its leading features will be given.*

Fig. 102 contains a general view of the instrument, mounted on a rocking platform, AAA, the motions of which represent those of the deck of a ship rolling in a seaway. The surface of the rocking platform to which the instrument is secured is shown at a considerable inclination, and the fixed frame upon which it rocks will be readily distinguished.

Two fundamental principles, already explained, may be again mentioned in order to facilitate explanation: (1) if a pendulum of very short period is hung at the height of the centre of gravity of a ship rolling among waves, it will at each instant stand practically normal to the effective wave slope; (2) if a pendulum of very long period is hung in the ship, it will remain practically vertical while she rolls. In the instrument there are two such pendulums; when the ship is upright and at rest, they both occupy a vertical position which is marked on some part of the apparatus that accompanies the motion of the ship. When the ship rolls, the oscillations of the quick-moving pendulum indicate the angles of inclination, at every instant, of the masts of the ship to the normal to the effective wave slope; while the oscillations of the very slow-moving pendulum indicate the simultaneous inclination of the masts to the vertical. From these two records the angles of the effective wave slope at various times can be deduced, being the algebraical difference of the pendulum inclinations; and the profile of the effective wave surface can be constructed. In short, every important feature in the behaviour of the ship is brought within the scope of analysis, by means of the diagrams automatically traced by the instrument.

The quick-moving pendulum is shown in Fig. 102 by *r* (on the right side of the drawing, and about mid-height on it). It consists of a horizontal brass tube, filled with lead so as to form a heavy bar-pendulum; this is suspended at each end on knife-edges, situated near the upper part of the circumference of the bar. The bar is only $2\frac{1}{2}$ inches in diameter, and about 20 inches long; so that

* For further details see vol. xiv. of *Transactions* of the Institution of Naval Architects; from which most of the

particulars given in the text and the drawing of the instrument are taken.

the arrangement really produces a powerful and sensitive pendulum, of less than 2 inches in length, and consequently having a period of about two-tenths of a second only. It carries an arrangement of light arms (p), at the end of which is a pen, s ; and as the bar-pendulum swings to and fro, the pen s registers the motion upon a sheet of paper carried by the cylinder k , which is driven by

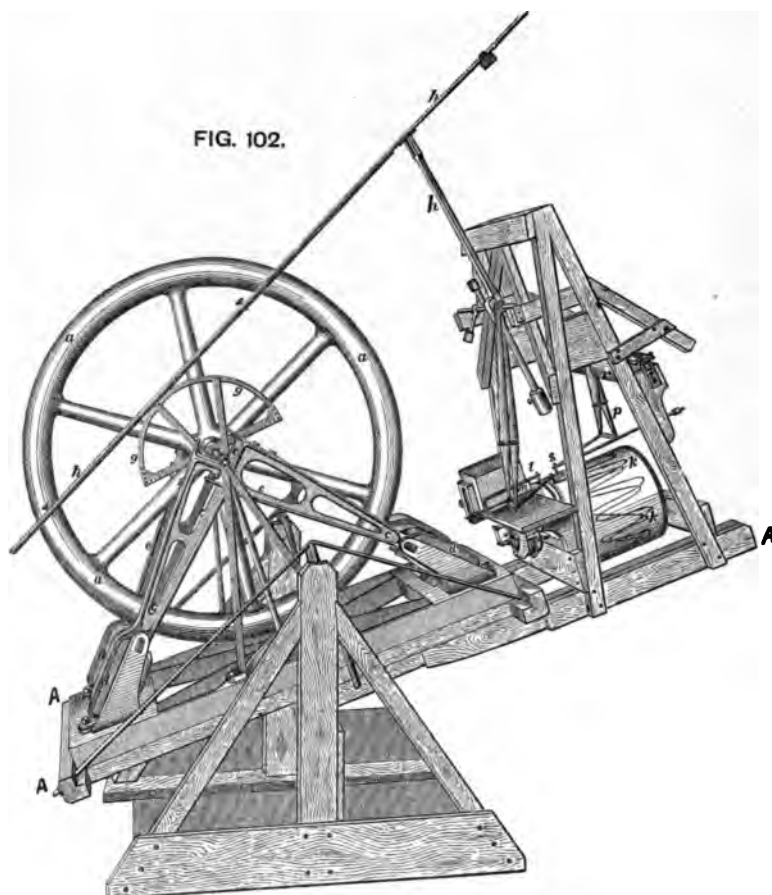

clockwork. The pen s traces on the paper a continuous line, and as the cylinder k revolves, another piece of clockwork l marks upon the paper a "scale of time"; so that the diagram produced shows not merely the successive inclinations of the ship to the effective surface, but also indicates the times at which those inclinations are attained. The interval of time marked by this scale, between two consecutive extremes of inclination, will show the "period" of the corresponding oscillation.

Considerable practical difficulties had to be overcome in con-

structing the second pendulum, which has a very long period. It consists of a heavy-rimmed wheel (a , in Fig. 102), 3 feet in diameter, weighing 200 lbs.; this is carried on an axis of steel, 1 inch in diameter, the centre of gravity of the whole being only six-thousandths (0.006) of an inch away from the centre of the axle. Here we see an arrangement identical in character with a ship having very little initial stability, but great inertia, the two contributing to produce a very long period. The observed time for a single swing of this wheel-pendulum, as it may be termed, has been found to be about 34 seconds; the magnitude of this period becomes evident when it is remembered that the slowest-moving ships have periods for a single roll of about 8 to 10 seconds, and that the half-period of the largest waves commonly met with are still less. Friction rollers (c, c) support the steel axle; and the extreme delicacy of the suspension of this heavy wheel is attested "by the fact, that, when "at rest, a breath on the circumference (of the wheel) will move it "perceptibly." This wheel-pendulum continues almost unmoved as the ship rolls. The effects of any very small motion which the wheel may acquire are easily eliminated, and it practically indicates at every instant the true vertical direction, as well as the inclination thereto of the masts. This wheel is also made to record its motions on the revolving cylinder k . A wooden semicircle g is carried on the axis, and by means of the light rods h, h —which are carefully counterbalanced—the relative angular motions of the ship and the steady wheel are made to move a pen, m , which draws a curve on the paper stretched upon the cylinder k . The character of this curve is similar to that traced by the pen s , moved by the pendulum r ; and both these curves are indicated by the curved lines shown on the cylinder k , the rotary motion of the cylinder and the motion of the pens parallel to its axis combining to produce this result. The time scale is the same for both curves; and on that traced by the pen m the time interval between any two consecutive extremes of inclination measures the corresponding period of oscillation of the ship. When the observations are over, the paper can be removed from the cylinder k , and the diagrams drawn by the automatic apparatus can be analyzed. They furnish the following information:—

(1) The relative inclination of the ship and the effective wave slope at any instant.

(2) The inclination of the ship to the vertical at any instant.

(3) The period of oscillation of the ship at any time—that is, the number of seconds occupied in completing the roll from port to starboard, or *vice versa*.

From 1 and 2 may also be deduced:—

(4) The angle of slope of the effective wave surface at any instant.

(5) The period of this effective wave, which will agree with the *apparent period* of the surface waves when the ship is floating among relatively large waves.

If, therefore, careful observations are made, while the instrument is at work, of the dimensions and periods of waves, the comparison between the observed slope of the surface wave and the deduced slope of the effective wave furnishes a test of the correctness of the ordinary assumptions as to the effective wave slope. It also enables estimates of the probable rolling of future ships to be made more precise by thus determining the character of the effective wave surface.*

In the instrument constructed by M. Bertin the heavy wheel-pendulum has a period, for a single swing, of 40 seconds; and the quick-moving pendulum a corresponding period of 2 second. Each pendulum automatically records its indications. M. Bertin has made several series of observations with this instrument, including pitching as well as rolling observations in his work, and the results obtained, as well as their analysis, constitute one of the most valuable additions made in recent years to the experimental study of the oscillations of ships.†

It will be obvious that the wheel-pendulum of either of these automatic instruments, stripped of its appliances for recording its indications, would constitute a very trustworthy substitute for the ordinary pendulums whose errors have been described above. Some simpler instrument embodying the same principles will probably yet come into general use as a substitute for the pendulum.

Another most ingenious instrument for determining the true vertical in a ship rolling and pitching at sea has been devised by Mr. B. Tower, in connection with his apparatus for providing a steady platform for guns, search-lights, etc.‡ The essential features of the apparatus include the following: (1) A heavy cast-iron disc wheel mounted on a cup-bearing, and made to revolve in a horizontal plane on a spherical journal resting in the cup, by means of water

* Independently of the use of this instrument, naval officers might do much to add to existing knowledge on this point if they associated ordinary batten observations with simultaneous observations of the angles indicated by short pendulums hung at the height of the centre of gravity of the ship. Great care would be required to ensure

the simultaneity of the records of battens and pendulums if this plan were adopted.

† *Observations de roulis et de tangage faites avec l'oscillographe double*, par M. Bertin.

‡ See the full description and drawings published in the *Transactions* of the Institution of Naval Architects for 1889.

supplied from a pump at a pressure of about 100 lbs. per square inch. The water passes through the bearing into the central cavity of the wheel, and thence through radial passages to two small tangential jets at the rim of the wheel. The reaction of the issuing jets causes the wheel to make about 1000 revolutions in a minute. (2) The wheel has its centre of gravity a very small distance below the centre of suspension, and is therefore, when revolving, a conical pendulum of very long period. The complete period of its conical oscillation round the true vertical is 90 seconds. (3) The wheel has most of its weight carried on the water pressure on the cup-bearing; friction is thus lessened, and the wheel is free not merely to revolve, but also to perform its conical oscillations (or "wobbling") in relation to the cup-bearing and the frame carrying it. Both the bearing and the frame are rigidly connected with the vessel, and move with her.

Supposing the vessel to be rolling before the high-pressure water is admitted to the disc wheel; it rests in its bearing and moves with the ship. Directly the water is admitted and the wheel made to revolve rapidly, it ceases to move with the ship, but becomes a very slow-moving conical pendulum, and very soon settles down to a truly horizontal plane. In other words, the ship virtually rolls about it just as it would about the heavy-rimmed wheel-pendulum in Mr. Froude's apparatus. A pointer fixed at right angles to the disc wheel, therefore, indicates the true vertical, and by simple apparatus the arcs of oscillation on either side of the vertical could be automatically recorded. No matter what may be the position of the wheel when its rotation begins, in a very short time it assumes the horizontal position, and for all practical purposes maintains it. This has been demonstrated both by observations made on a vessel rolling through considerable angles in a seaway, and by rolling experiments in still water.

It should be understood that this invention is primarily designed to secure a steady platform, and not to measure rolling or pitching. The arrangements by which this is secured cannot be fully described here, but they are so novel and beautiful in their character as to deserve careful study. From the cavity in the body of the disc wheel an axial pipe is led upwards, ending in a jet co-axial with the wheel. The high-pressure water issuing from this jet acts upon a system of four pipes with their ends brought close together, each leading to one of four cylinders, in which rams work up and down. These rams are made to carry, on a frame and gymbals, the platform which is to be steady. The effect of the axial jet is to cause the rams on the cylinders to move so as to bring the centre of the jet exactly opposite the centre of the ends of the four pipes. Con-

sequently the platform is always maintained practically parallel to the horizontal plane of rotation of the disc wheel. If moved away from this parallelism, the platform speedily returns to it; and no reaction is possible on the wheel, since the water-jet alone transmits the force which steadies the platform. No doubt considerable use will be made of this principle in future.

Before concluding this chapter, it may be well to repeat that, whatever method of observing the rolling or pitching may be adopted, the observations made cannot have their full value unless the attendant circumstances are fully recorded. For example, the *actual condition of the ship* at the time should be noted; whether she is under sail or steam; what portions of her consumable stores remain on board; whether the boilers are full or empty; whether there is anything unusual in her stowage; whether there is any water in the bilges; and any other features that would affect the still-water period of oscillation. Her *course and speed* should also be stated, the former being given relatively to the line of the wave-advance, and the angle between the two being stated in degrees where possible. The dimensions and periods of the waves, both real and apparent, should also be carefully determined, as explained in Chapter V. No change should be made affecting the behaviour of a ship for some time before the observations are commenced, nor during their progress; a change of course, an alteration in the sail spread, a change of speed, or any other changes, made immediately before the observations began, might seriously influence the behaviour during the comparatively short time over which a series of observations extends; and it is needless to point out the necessity for avoiding any changes during that short time. The Admiralty instructions enforce these conditions, providing that no change of course or speed, or spread of sail, etc., shall be made for at least ten minutes before the observations are commenced.

One of the most perfect sets of observations of the behaviour of a ship yet made were those conducted by the late Mr. Froude, on behalf of the Admiralty, on board the *Devastation*. But unfortunately for the scientific interest of the case, the weather encountered during the passage of that ship to the Mediterranean in 1875 was so moderate as neither to severely test her qualities nor to afford good opportunities for showing the full capabilities of the automatic instrument. Every naval officer proposing to enter upon similar work may read with advantage the brief report drawn up by Mr. Froude on the observations made during the passage.*

Ordinary observers have not similar advantages, but with the aid

* Published as *Parliamentary Paper* No. 104 of 1876.

of the appliances in common use much valuable information has already been furnished, and it is to observations of a similar character we must look chiefly for still further facts bearing on the behaviour of ships at sea. An intelligent acquaintance with the main deductions from modern theory, as well as with the moot points of the subject, will enable the observer to supply much more valuable information, seeing that he will be capable of distinguishing the more important from the less important conditions, and of giving a practical direction to his inquiries.

CHAPTER VIII.

THE STRAINS EXPERIENCED BY SHIPS.

THE structure of a ship floating at rest in still water is usually subjected to various straining forces tending to produce changes of form. When she is rolling and pitching in a seaway, or propelled by sails or steam-power, these straining forces become greater, while others are developed. In order to provide the necessary structural strength, the naval architect has to make choice of the materials best adapted for shipbuilding, and further to distribute and combine these materials so as most efficiently to resist changes of form or rupture of any part. By these means he seeks to secure the association of lightness with strength to the fullest possible extent. Before this intention can be accomplished satisfactorily, the designer of a ship must have an intelligent appreciation of the causes and character of the strains to be provided against; otherwise materials may be concentrated where strength is not chiefly required, or *vice versa*. The importance of such knowledge has been recognised from the time when the construction of ships began to receive scientific treatment, but in this, as in most other branches of the subject, the greatest progress has been made within comparatively recent times. We now propose attempting a brief popular sketch of the chief straining actions to which ships are subjected, and in a subsequent chapter will discuss the principles of the structural strength of ships.

The magnitude of the forces acting upon the structures of ships obviously cannot be measured by the observed effects. When the strength and rigidity of a structure are ample in relation to the forces acting upon it, there will be no visible change of form; whereas forces of equal magnitude acting on a weaker structure may produce deformation, and thus illustrate the tendency of the forces in question. Wood ships, for example, actually bend longitudinally under the action of forces which would produce no similar bending in well-built iron or steel ships, because they are stronger. In many cases wood ships alter form transversely, "working" at

the junctions of the decks and sides, or at the bilges, when rolling in a seaway. Forces of equal intensity acting upon stronger iron or steel ships may give no external evidence of their existence. In both cases the tendency to produce change of form is the same; and the maintenance of form is no evidence of the absence of straining forces, or of their small amount.

The chief strains to which ships are subjected may be classified as follows:—

1. Strains tending to produce longitudinal bending—"hogging" or "sagging"—in the structure considered as a whole.

2. Strains tending to alter the transverse form; *i.e.* to change the shape of athwartship sections of a ship.

3. Strains incidental to propulsion by steam or sails.

4. Strains affecting particular parts of a ship—"local strains"—tending to produce local damage or change of form, independently of changes in the structure considered as a whole.

Besides these there are other strains, of less practical importance, which are interesting from a scientific point of view, but need not now be discussed, as there is ample strength in the structure of all ships to resist them, and there is no necessity in arranging the various parts to make special provision against them. Vertical *shearing forces*, for example, are in action in all ships; they tend to shear off the part of a ship lying before any cross-section from that abaft it; but no such separation of parts has been known to take place, nor is it likely to be accomplished in ordinary ships.

The order indicated in this classification is that which will be followed in our description, being the order of relative importance of the straining actions. All of them require consideration, but, while it is not difficult to provide against the last two classes, it is important to bestow careful attention on the prevention of changes of transverse form, and it is still more difficult to prevent longitudinal bending.

Longitudinal Bending Moments in Still Water.—The case to be first considered is that of a ship floating *at rest in still water*. It has already been shown that there are two essential conditions of equilibrium: the ship must displace a quantity of water having a weight equal to her own weight, and her centre of gravity must be in the same vertical line with the centre of buoyancy. These two conditions may be fulfilled, however, and yet the weight and buoyancy may be very *unequally distributed*; the result being the production of longitudinal bending moments. As a very simple illustration, take Fig. 103, representing a ship floating at rest in still water. Supposing her to be divided by a number of transverse vertical planes (*ab*, *ab*, etc.), let each piece of the ship between two con-

secutive planes of division be considered separately. At the bow there will probably be portions for which the weight exceeds the buoyancy; these excesses of weight are indicated by W_1 and W_2 . Amidships the fuller form of the ship gives greater buoyancy to

FIG. 103.

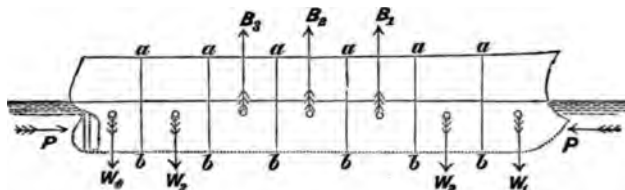

those subdivisions, and it is very common to find the buoyancy exceeding the weight, as indicated by B_1 , B_2 , B_3 , in the diagram. At the stern also the weight is likely to be in excess, as shown by W_3 and W_4 . The sum of these excesses of buoyancy will evidently balance the sum of the excesses of weight at the extremities; and the second hydrostatical condition of equilibrium requires that the

FIG. 104.

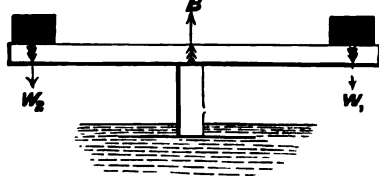

resultant moment of these two sets of forces about any point shall be zero. It will be seen that a ship thus circumstanced is in a condition similar to that of the beam in Fig. 104, which is supported at the middle, and loaded at each end. Such a beam tends to become

curved, the ends dropping relatively to the middle, and the ends of the ship tend to drop similarly, the change of form being termed "hogging." Hogging strains are very commonly experienced at every part of the length of ships floating in still water.

If the conditions of Fig. 103 were reversed, the excesses of buoyancy occurring at the extremities, and those of weight amidships, the ship would resemble a beam supported at the ends and loaded at the middle of the length. The middle would then tend to drop relatively to the ends, a change of form sometimes occurring in ships, and known as "sagging." In all, or nearly all, ships, when floating in still water, the fine form of the extremities under water makes the buoyancy of those parts less than the corresponding weights; so that sagging strains are rarely experienced throughout the whole length of a ship in still water. Among waves, as will be seen hereafter, the conditions may be changed so as to produce sagging strains at every part of the length of a ship.

The opinion is sometimes expressed that, whenever there is an excess of weight amidships in a ship, sagging strains will be de-

veloped; but this is not a necessity. Suppose, for example, that Fig. 105 represents a vessel having an excess of weight (W_2) amid-

FIG. 105.

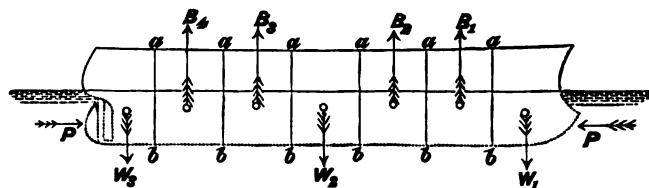

ships as well as at the extremities, and excesses of buoyancy at the intermediate portions. This is the condition of very many ships, such as paddle-steamers with their machinery concentrated in a comparatively small length amidships, or ironclads with central armoured breastworks or batteries overlying the spaces occupied by the machinery. Such a vessel may be compared to the beam in Fig. 106, supported at two points, and laden at the middle and ends. According to the view mentioned above, sagging strains should then be produced under the middle load; but it is easy to show that this may or may not be the case. For this purpose a short explanation is needed of a few simple principles, the application of which is general to ships as well as to beams.

FIG. 106.

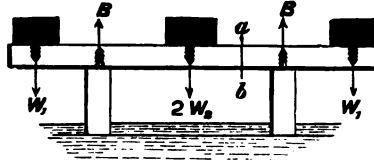

Suppose it is desired to obtain the "bending moment" at any section—say ab —of the beam in Fig. 106. Conceive the beam to be rigidly held at that section, and reckoning from either end of the beam up to ab , let an account be taken of every force acting upon it, load and support, as well as of the distance of the line of action of each force from the selected section ab . Multiply each force by the corresponding distance, add up separately the moments of the loads and supporting forces, and the differences of the two sums will be the bending moment required. It is immaterial which end is reckoned from in estimating the bending moment. As a very simple case, suppose it to be desired to find the bending moment of the forces acting upon the middle section of the beam in Fig. 106. Let the weight of the beam be neglected, and the supports be midway between the middle of the length and either end. Suppose the following values to be known :—

$$4l = \text{distance between the loads on ends of beam ; } W_1 = \text{load on either end ; } 2W_2 = \text{load in middle.}$$

Then each support will sustain a pressure (B) equal to $W_1 + W_2$. For the bending moment at the middle of the beam, we must have—

$$\text{Bending moment} = W_1 \times 2l - (W_1 + W_2)l = (W_1 - W_2)l.$$

Hence it will be seen that the following conditions hold:—

(a) If W_1 is greater than W_2 , there will be a *hogging* moment at the middle of the beam, and no section will be subjected to sagging moment, notwithstanding that the middle load $2W_2$ is carried.

(b) If W_1 is less than W_2 , there will be a sagging moment at the middle of the beam.

(c) Even in this second case the sections of the beam situated between the ends and the supports will be subjected to hogging moments, and so also will some part of the beam lying between the supports and the middle.

The case of the ship is similar, but more complex, the estimate of the bending moment experienced by the midship section involving the consideration of many vertical forces, some acting upwards and others downwards. But the foregoing is an illustration of the general mode of procedure; and the conditions of the existence or non-existence of sagging strains amidships stated for the beam are paralleled by somewhat similar conditions for the ship. Reckoning from the bow or stern of a ship to the midship section, or to any other cross-section, it is easy to estimate the bending moment when the relative distribution of the weight and buoyancy has been determined. This is a laborious rather than a difficult operation, and may be briefly described.

The longitudinal distribution of the buoyancy in a ship floating at rest in still water may be readily determined from the calculations made for her displacement up to any assigned water-line, and can be graphically represented in a simple fashion. Fig. 107 illustrates this. The base-line AB represents the length of the ship. At equi-distant intervals ordinates are drawn at right angles to the base; these may be assumed to correspond to hypothetical planes of division, such as *ab*, *ab* in Fig. 105. For each such plane of division the area of the immersed portion of the corresponding cross-section of the ship is determined, and on the corresponding ordinate in Fig. 107 this area is set off to scale. A series of points is thus determined, through which the "curve of cross-sectional areas" BBB is drawn. This curve clearly represents the longitudinal distribution of the buoyancy of the ship up to the assigned water-line, and is therefore commonly styled the "curve of buoyancy." Its area represents the total buoyancy or displacement to the assigned load-line. If, midway between any two of the ordinates, a line is drawn perpendicular to

AB, the length of this line will represent (to scale) the buoyancy (say in tons) of the portion of the ship lying between the planes of division corresponding to those ordinates. So long as the same

FIG. 107.

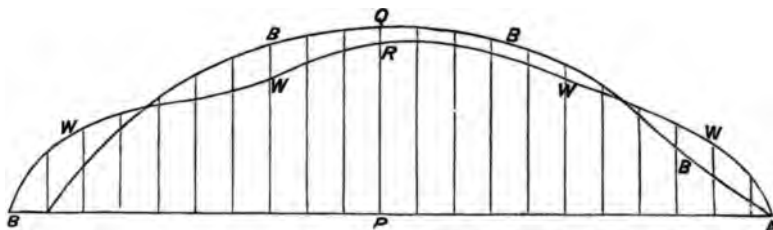

draught and trim are maintained the curve of buoyancy obviously remains unaltered, although great changes may be made in the longitudinal distribution of the weights on board a ship.

The determination of the longitudinal distribution of the weight of a ship is less simple, and a large amount of work is involved. Ordinarily separate estimates are made of the longitudinal distribution of the *fixed* weights—such as the structure and equipment of the ship, the engines and boilers—and of the longitudinal distribution of *varying or consumable* weights—such as coals, cargo, or other lading. For each portion of the length of a ship situated between two planes of division, the weights are separately estimated for the hull and lading. Then on a line drawn perpendicular to the baseline AB, and midway between the ordinates corresponding to the two planes of division, a length is set off representing the weight of that portion of the ship, on the same scale as was used for the curve of buoyancy. A series of points is thus determined, through which is drawn what is termed the “curve of weight,” WWW, Fig. 107. Sometimes two such curves are drawn, one representing the fixed weights of hull, machinery, etc.; and a second, superposed upon it, representing the variable or consumable weights. The area enclosed by the curve WWW represents the total weight of ship and lading. It will be understood that such a curve as WWW does not exactly represent the distribution of weight; the true graphical representation would not be a curve, but an irregular and discontinuous outline. In fact, it is not unusual to construct the graphical representation of the longitudinal distribution of the weight in this fashion, instead of averaging its irregularities in the form of a curve like WWW. Either process may be used with close approximation to accuracy, when estimating the longitudinal bending moments.

The conditions of equilibrium for a ship floating at rest in still water require that: (1) the total area enclosed by the curve of

weight shall equal the total area enclosed by the curve of buoyancy; (2) that the centres of gravity of the two areas shall be on the same ordinate.

Taking any ordinate (say PQ in Fig. 107), the intercept (QR) between the two curves represents the excess (or defect) of buoyancy at that place. Where the curve of buoyancy lies outside the curve of weight (reckoning from the base-line AB), buoyancy is in excess; where the curve of weight lies outside, the weight is in excess; at the sections where the curves cross, the weight and buoyancy are equal, and these are termed "water-borne" sections. A more convenient mode of representing these excesses or defects of buoyancy is furnished in Fig. 108. Here the base-line and the dotted ordinates

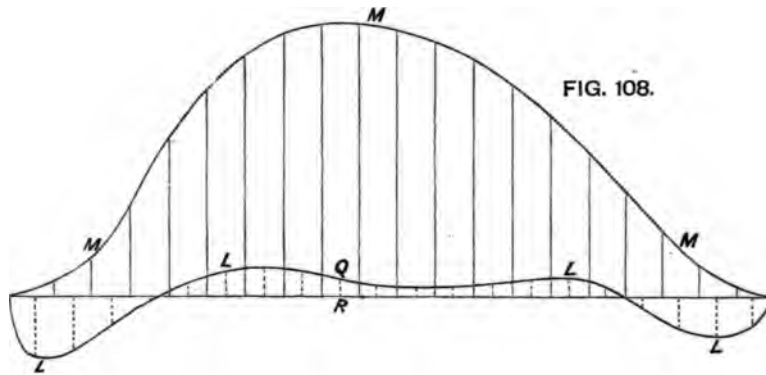

correspond to those in Fig. 107; and on any ordinate of those curves the intercept (say QR) is measured and transferred to the corresponding ordinate QR in Fig. 108, being set above the base-line AB when the buoyancy is in excess, and below when the weight is in excess. The curve LLL drawn through the points thus determined is termed the "curve of loads," and indicates at a glance the unequal distribution of weight and buoyancy. The total area enclosed by the parts of this curve lying above the base-line must equal that of the parts lying below that line.

Having constructed the curve of loads for any ship floating at a certain water-line and laden in a specified manner, it is easy to obtain the value of the longitudinal bending moment at any cross-section. This may be done either by direct calculation in the manner explained above, or by simple processes of "graphic integration" from the curve of loads. A first integration of that curve gives the "curve of shearing forces"; which, being itself integrated, gives ordinates of the "curve of bending moments" (such as MMM in Fig. 108). Any ordinate of the latter curve represents, to scale, the bending moment (usually expressed in foot-tons) at the corresponding cross-

section of the ship. Ordinates set off *above* the base-line indicate "hogging" moments, while "sagging moments" are indicated by ordinates set off *below* the base-line.

From the preceding remarks, it will be obvious that a necessary preliminary to calculations for longitudinal bending moments is the knowledge of the distribution of the weights carried by a ship. For all ships it is possible to deal with the "extreme light condition" when they are cleared of cargo and lading. The draught and trim corresponding to that condition can be ascertained, and the distribution of their "fixed" weights can be estimated as explained above; so that curves of loads and bending moments can be constructed. Very often the magnitude of the straining forces corresponding to this extreme light condition, which can only be reached in harbour or dock, exceeds the corresponding still-water strains for laden ships. Formerly the case had considerable practical importance, as many wood-built sailing ships, when laid up in ordinary with weights usually stowed amidships removed, "hogged" to a very sensible extent. Under existing circumstances, with iron or steel ships, the extreme light condition usually has only a theoretical interest; although, as above stated, the curve of weight corresponding to that condition is commonly determined, as a basis on which to superpose any known or assumed distribution of weights carried by a laden ship.

War-ships are designed to carry known weights of armament and equipment in definite positions. It is easy, therefore, to pass from the extreme light condition to the fully laden condition of such ships; or to their condition when specified consumable weights of coal, ammunition, or stores have been removed. In most cases only the extreme light and the fully laden conditions are investigated. Merchant ships are necessarily subject to greater variations, and this is particularly true of cargo-carriers, since the character, weight, and disposition of their lading vary from voyage to voyage. The only fixed condition for merchant ships is consequently the extreme light condition, and for the laden condition either assumptions must be made of the character and stowage of the cargo, or those particulars must be obtained from actual observation. The former is more commonly done, and certain typical cargoes taken for purposes of calculation. Frequently, for purposes of comparison, a *homogeneous cargo*, practically filling the internal spaces, is assumed; and for this case the calculations are simple. For cargo-steamers it is also common to assume, for purposes of calculation, that exceptionally heavy cargoes, such as railway bars or iron ore, are put on board in positions such as experience shows to be suitable. In all these cases it is now the rule, not merely to investigate the fully laden condition with *bunkers full*, but also the condition when the voyage

is practically completed and *bunkers nearly empty*, while the cargo still remains on board. This last condition is usually the most critical as regards the magnitude of longitudinal bending moments.

Calculations of the character above described have been extensively made during the last twenty-five years. At a much earlier period writers on the theory of naval architecture attempted investigations of longitudinal bending. The closest approach to modern methods was made by Dr. Young, in a remarkable report to the Admiralty on the diagonal system of constructing wood ships introduced by Sir Robert Seppings.* Until iron shipbuilding began to be developed, the subject received but little further attention. The late Professor Rankine clearly laid down the principles on which longitudinal bending moments should be estimated,† but did not have the opportunity of making detailed calculations for actual ships. Such calculations have since been carried out at the Admiralty and the Royal Naval College for various classes of war-ships; and by the officers of Lloyd's Register of Shipping for different types of merchant ships. Private shipbuilders have also made many similar investigations. As the result of this extended study of the subject, much more exact knowledge is now available respecting the longitudinal strains experienced by ships.

A few typical illustrations of the actual distribution of the weight and buoyancy of war-ships when floating in still water, and of the resulting longitudinal bending moments, will be of interest.‡ For such ships, as has been explained, the weights of lading are placed in defined positions, and the conditions are more fixed than in merchant ships. For the latter some similar illustrations will be given hereafter.

The diagrams in Figs. 107 and 108 represent the case of her Majesty's ship *Minotaur* (armour-plated frigate, 400 feet in length). She is a vessel completely protected by armour throughout her length from the upper deck down to some 6 feet under water; the finely formed ends are thus burdened with an excess of weight, the actual distribution of the weight and buoyancy being as follows:—

* See *Transactions* of the Royal Society for 1814.

† See "Shipbuilding Theoretical and Practical," edited by Professor Rankine.

‡ For fuller details see the Memoir published in the *Philosophical Transactions* of the Royal Society for 1871, containing an account of the work which was done at the Admiralty under the direction of Sir Edward Reed, when chief

constructor of the Royal Navy. The author had the honour of assisting in the preparation of this Memoir, from which many of the facts stated in the text are taken. See also a paper contributed by the author to the *Transactions* of the Institution of Naval Architects for 1877, giving the results of calculations made at the Royal Naval College.

First 80 feet from the bow	.	weight 420 tons in excess.
" 70 " " stern	.	" 450 " "
250 feet amidships	.	buoyancy 870 " "

This vessel in still water furnishes, therefore, an example of the condition of the beam in Fig. 104, p. 300. Hogging moments are experienced by all athwartship sections throughout the length. The curve MMM in Fig. 108 indicates the variation in the bending moments from end to end of the ship; the length of any ordinate measuring the bending moment experienced by the corresponding cross-section in a ship. This is a very common case of the distribution of weight and buoyancy in war-ships, including the older types of sailing ships and many steam-ships. The excesses of weight at the extremities are, however, proportionately greater in an armoured vessel like the *Minotaur* than they are likely to be in unarmoured ships, and this exaggerates the maximum bending moment experienced by the midship section.

The magnitude of bending moments in still water, as above remarked, does not necessarily increase with deeper lading, and for a given water-line and total displacement differences of stowage will greatly influence the strains. For example, if the armour were taken off the bow and stern of the *Minotaur* and stowed amidships, the excesses of weight at the extremities and of buoyancy amidships would be lessened, causing a great reduction in the hogging moments at the midship section and elsewhere. On the other hand, if the *Minotaur* floats light, with engines, boilers, and all equipment removed as for a general repair, the excesses of weight over buoyancy at the extremities and of buoyancy over weight amidships become much greater than they are in the fully laden condition. Instead of an excess of weight forward of 420 tons, there is, when light, an excess of 560 tons; while aft the excess increases from 450 to 500 tons; and amidships, on a length of some 230 feet, when the ship floats light, there is an excess of buoyancy of 1060 tons, as against 870 tons in the fully laden condition. The vessel is therefore subjected to much severer hogging strains when floating light in still water than she is when fully equipped. This is by no means an exceptional condition, and it explains the well-known fact that wood vessels often hogged most soon after they were launched, or when lightened for thorough repairs. It was the practice formerly to place ballast on board ships lying in reserve, in order to prevent hogging.

In the *Devastation* class of the Royal Navy, a far less simple distribution of the weight and buoyancy is found than that occurring in the *Minotaur* type. Figs. 109 and 110 illustrate this case. The

spur-bow and full form forward, as well as the absence of high armoured ends in the *Devastation*, make the excess of weight very small as compared with the *Minotaur*—about 60 tons excess only on the first 20 feet of length. Then follows about 57 feet of length,

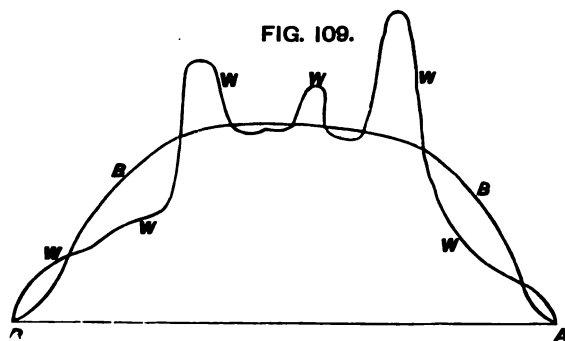

before the central breastwork, where buoyancy is in excess by about 520 tons; this is succeeded by a great excess of weight—550 tons on 32 feet of length—under the foremost turret. Along the central part of the ship, where the armoured breastwork is situated, and the machinery and boilers are placed, there is very nearly a balance of weight and buoyancy, the difference not amounting to more than

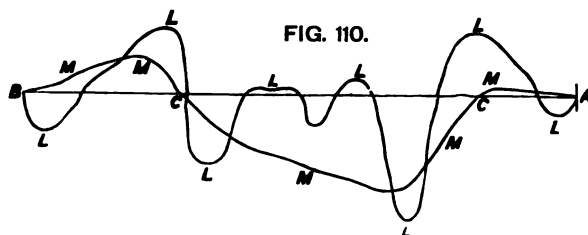

10 tons on a length of 75 feet, although, as shown by the diagrams, there are two small excesses of buoyancy and one small excess of weight, the latter being due to the conning-tower. Under the after turret, another large excess of weight occurs—320 tons on 38 feet of length; followed by a still larger excess of buoyancy—570 tons on a length of 63 feet; thence to the stern there is an excess of weight of 170 tons, owing to the fineness of the form of the ship in the run. These variations are indicated by the curves of weight (WWW) and buoyancy (BBB) in Fig. 109, but are more clearly shown by the curve of loads (LLL) in Fig. 110. The resultant bending moments are shown by the curve MMM, and offer a remarkable contrast to those for the *Minotaur* (see MMM, Fig. 108). For the first 50 feet from the bow there is scarcely any pending moment to be resisted in the *Devastation*; whereas in the *Minotaur* the moment at the corre-

sponding part amounts to about 8000 foot-tons. At the after part also the hogging strains in the *Devastation* are very small, the greatest hogging moment being less than one-seventh as great as that in the *Minotaur*. But the most marked contrast is found amidships; the concentration of weight in the turrets of the *Devastation*, the absence of great excesses of weight at the ends, and the altered distribution of the excesses of buoyancy, develop sagging moments, indicated in Fig. 110 by the ordinates of curve MMM being drawn below the base-line AB. The maximum bending moments are also made much more moderate. The maximum sagging moment in the *Devastation* is only a little over one-third the maximum hogging moment in the *Minotaur*; the exact figures are 15,300 foot-tons for the *Devastation*, and 45,000 foot-tons for the *Minotaur*. Part of this reduction in bending moment is undoubtedly due to the less length of the *Devastation*; but expressing the maximum bending moment as a fraction of the product of the length by the displacement—which is the fairest method—it is about $\frac{1}{17}$ for the *Devastation* against $\frac{1}{8}$ for the *Minotaur*.

When the excesses of weight and buoyancy are differently distributed in a ship having an excess of weight amidships, her condition may be intermediate between the two extremes already illustrated. The *Invincible* is an example of this intermediate class. When fully laden, there is an excess of weight of 115 tons on the first 35 feet from the bow, then an excess of buoyancy of 220 tons on a length of 65 feet; amidships, under the double-storied central battery, there is an excess of weight of 275 tons on a length of 80 feet; next an excess of buoyancy of 380 tons on a length of 70 feet, and on the last 30 feet of length to the stern an excess of weight of 210 tons. The result of this distribution of weight and buoyancy is to develop maximum hogging moments in the fore and after bodies, corresponding to those experienced by the *Devastation*; but at the midship section, instead of a sagging moment, there is a *minimum* value of the hogging moment, about one-third as great as the maximum bending moment experienced by the after body.

In this case, and in many others which occur in practice, the still-water bending moments reach their maxima at sections lying at a considerable distance from the middle of the length. These still-water straining forces, while much less severe than those occurring when ships are among waves, are experienced more frequently, and may be termed the "permanent" strains on the structure. Consequently it is important to understand their distribution and to estimate their values. Amongst waves the greatest values of the bending moments are usually experienced by sections near the middle of the length.

As an illustration of the possible distribution of weight and buoyancy in merchant ships, and the resulting bending moments, the case may be taken of a cargo steamer of the "well-deck" type.* This vessel was 290 feet long, 38 feet broad; and when cleared of cargo and coals, in the *extreme light condition*, weighed about 1350 tons. When laden to her deep load-line, she carried 3250 tons of cargo and 340 tons of coal, the total displacement being 4940 tons. Machinery, boilers, and bunkers were in a compartment near the middle of the length. Aft this compartment was a single after hold. Between the machinery space and the collision bulkhead the interior was subdivided by a transverse bulkhead into a main and fore hold.

In the extreme light condition (Fig. 111), the ship floating in still water, the weight exceeded the buoyancy for about 30 feet from

FIG. 111.
LIGHT CONDITION.

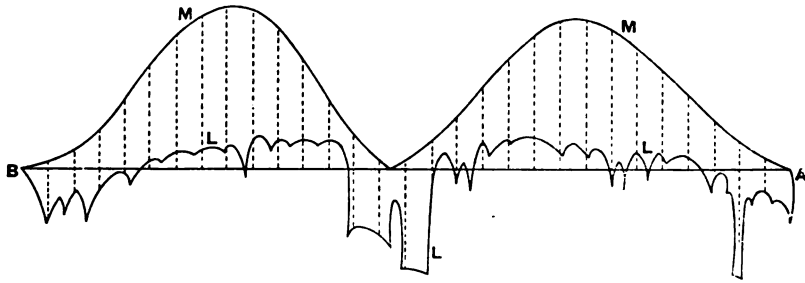

the bow and an equal distance from the stern, as well as in wake of the machinery compartment. At other parts of the length there were excesses of buoyancy, balancing these excesses of weight. At the middle of the length there was practically *no bending moment*. Starting from the bow, hogging moments were experienced by all cross-sections in the fore body. The maximum moment occurred about 85 feet from the bow, and was about 6000 foot-tons. Thence towards the middle of the length the hogging moments gradually diminished, reaching a zero value amidships. The after body was

* These calculations were made by Mr. Bergström, and the details will be found in papers contributed by him to the *Transactions* of the North-East Coast Institution of Engineers and Shipbuilders for 1889-90, in which also appear the results of extensive calculations for various types of merchant ships made by M. Piaud of the Bureau Veritas.

In the *Transactions* of the Institution of Naval Architects from 1874 onwards are published many papers bearing on this subject prepared by the officers of Lloyd's Register of Shipping, as well as by private shipbuilders. Other papers of interest appear in the *Transactions* of the Institution of Engineers and Shipbuilders in Scotland.

similarly circumstanced, experiencing hogging moments throughout, the maximum value occurring about 90 feet from the stern, and being about 6500 foot-tons. This case will be seen to be intermediate between those above described for the *Devastation* and *Invincible* types.

Laden with *homogeneous cargo* filling the internal spaces and with *bunkers full*, very different conditions held good, as indicated in Fig. 112. At the extremities, there still remained small excesses of weight. In wake of the foremost hold there was an excess of buoyancy, followed by an excess of weight in wake of the main hold situated before the machinery compartment. In wake of that compartment there was an excess of buoyancy on the whole, although at the centre of its length concentrated weights led to a small local excess of weight. Buoyancy exceeded weight slightly throughout the length of the after hold, and abaft this point to the stern there was an excess of weight. The resultant curve of bending moments was interesting. From the stern to the forward bulkhead of the

FIG. 112.
LOAD CONDITION.

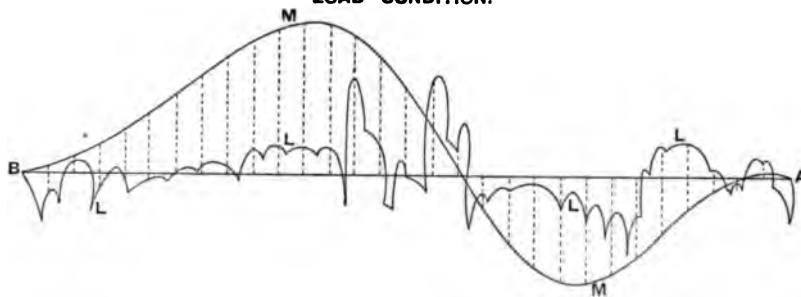

machinery compartment the structure was subjected to *hogging* strains, the maximum value of the bending moment occurring in the after body, about 100 feet from the stern, and reaching 6000 foot-tons. Before the machinery space until close up to the bow the structure was subjected to *sagging* strains, the maximum bending moment reaching about 4600 foot-tons, and occurring about 80 feet from the bow. The midship section had to bear a very small hogging moment; and at the bow, for a length of about 20 feet, there was also a hogging moment, but so small as to be of no practical importance. A further investigation was made when the bunkers were empty, but the vessel still laden with homogeneous cargo. The principal result was a considerable increase in the excess of buoyancy over weight in wake of the machinery compartment, and the diminution in the similar excesses in wake of the foremost hold and the after hold; while the excesses of weight over buoyancy in wake of the main hold

before the machinery and at the extremities were increased. The curve of bending moments underwent a remarkable change. Hogging strains were experienced throughout the length, the maximum bending moment exceeding 13,000 foot-tons, and occurring nearly amidships. Apart from calculation, it would scarcely have been anticipated that the consumption of 340 tons of coal, out of a total load of 3590 tons, would have caused this remarkable change in the character and magnitude of the bending moments. It has been previously remarked that this condition, with bunkers empty, is of considerable importance for laden merchant ships, and it is now commonly investigated as the critical case for bending moments, both in still water and among waves.

In concluding these remarks on longitudinal bending moments in still water, attention must be called to the fact that, besides the vertical forces of weight and buoyancy, a ship floating in still water has to resist longitudinal fluid pressures, tending to compress the lower part of the structure, and to produce longitudinal bending. Euler, and some of the other early writers on the subject, mentioned this fact, but they erred in their methods of estimating the effect of these pressures. In Figs. 103 and 105, pp. 300, 301, PP indicate the pressures, which balance one another when the ship is at rest; their bending moment may be stated approximately as equal to the product of P into the distance of the "centre of pressure" of the immersed midship section below the middle of the depth of that section, reckoning that depth from the upper deck to the keel.* This moment is never absolutely great, but it sometimes assumes relative importance, especially in vessels with concentrated weights amidships. For example, in the central-battery ironclad *Bellerophon*, the vertical forces develop a very small bending moment, whereas the longitudinal fluid pressures produce a moment of over 3000 foot-tons—about *one-fourth* of the maximum hogging moment experienced by any cross-section of the ship when floating in still water. In the *Invincible* class, a nearly identical ratio holds between the moment due to the horizontal fluid pressures and the maximum hogging moment, which is experienced by a section in the after body, in consequence of the unequal distribution of weight and buoyancy previously particularized. This branch of the subject is, however, interesting rather than practically important.

Longitudinal Bending Moments among Waves.—When a ship passes from still water to a seaway, great modifications must occur in the

* More exactly, the distance of the centre of pressure should be reckoned from a point a little above the centre of gravity of the sectional area of the parts on the midshipsection contributing resistance to bending.

longitudinal straining forces to which she is subjected. The existence of waves and the departures of wave-profiles from the level of still water must produce exaggerations in the inequality of distribution of weight and buoyancy. The rapid transit of waves past a ship must cause continual variations in this inequality of distribution, and in the magnitude and character of the bending moments. Moreover, the establishment of oscillations of the ship—pitching, 'scending, heaving, and dipping—must lead to the development of accelerating forces affecting the bending moments. The variations in the direction and magnitude of the fluid pressure incidental to wave motion, as well as the resistance offered by the water to oscillations of the ship, must also affect the straining forces. In attempting to estimate the resultant bending moment experienced by a ship floating among waves, the problem to be solved is obviously one of great difficulty. So many of the conditions are either unknown or only partly known that an exact solution is not to be hoped for. Under these circumstances certain conventional methods of calculation and comparison have been used, of which the chief will be described.

A ship is supposed to be upright and placed end-on to a series of waves, having lengths equal to her own length, and with fairly average ratios of height to length. From the facts set forth in Chapter V., it may be assumed that for lengths below 300 feet that ratio may be taken as 1 to 20; for lengths above 300 feet, as 1 to 25. Two extreme positions are taken for the ship in relation to the waves: one with the middle of her length coincident with a wave crest (Fig. 113); another with the middle of the length coincident with the wave

FIG. 113.



hollow (Fig. 114). The influence of the wave motion upon the direction and magnitude of the fluid pressure at any point in the wave is neglected. The wave water is assumed to deliver its pressure vertically, as in still water. In each of the selected positions the

FIG. 114.



vessel is supposed to rest in instantaneous statical equilibrium, displacing the same total volume as in still water, and having her centre

of gravity in the same vertical line as the centre of figure of the volume of displacement. Consequently, with a given distribution of weight (calculated as above described) the change from still water to either of the two selected positions, under the conditions assumed, produces alteration of the bending moments experienced in still water simply by reason of the alteration in the longitudinal distribution of the buoyancy. Although the assumptions are arbitrary, it will be of interest to trace their effects.

A glance at the diagrams shows how great a difference in the distribution of the buoyancy is produced by the passage of the wave; WL in each indicates the load water-line in still water. On the crest (see Fig. 113) the buoyancy at the extremities of the ship is decreased as compared with still water, the buoyancy amidships being considerably increased. In the hollow (see Fig. 114) the conditions are reversed; there is an increase of buoyancy at the bow and stern, which sink into the wave deeper than the level of WL, while there is a decrease of buoyancy amidships. Speaking generally, it may be said, therefore, that all classes of ships supported on the crest of a wave of their own length tend to *hog throughout their length*, the greatest hogging moment being experienced either by the midship section or a section lying near to it. This is true even for vessels with concentrated central weights. On the other hand, in all except very few and unusual cases, ships astride a wave hollow have excesses of buoyancy at the ends and excesses of weight amidships; consequently they are subjected to *sagging moments throughout the length*,* the maximum bending moment being experienced at or near the midship section, even by ships which in still water tend to hog throughout the length.

A few facts for the *Minotaur* and *Devastation* will more clearly illustrate the foregoing statement. When the *Minotaur* floats on the crest of a wave 400 feet long and 25 feet high, the excesses of weight at the bow and stern become increased to 1275 and 1365 tons respectively—about *three times* as great as the corresponding excesses in still water; the excess of buoyancy amidships being no less than 2640 tons. The maximum hogging moment borne by the midship section is 140,000 foot-tons—more than three times the maximum

* Special features may produce small excesses of weight at the bow or stern even when they are immersed in the adjacent wave slopes. For example, in the *Minotaur*, on the wave of her own length mentioned in the text, the heavily armoured bow has a very small excess of weight, 10 tons on 10 feet; and in the

Devastation, similarly circumstanced, the lowness of the freeboard leads to the extremities of the deck being buried deep in the wave slopes, excesses of weight of about 25 and 65 tons respectively occurring forward and aft. But these may be safely neglected, since the resultant hogging moments are very small.

hogging moment experienced in still water. These exaggerations of strain, however, leave the character of the strain unaltered, every transverse section being subjected to a hogging moment as in still water.

Astride the wave hollow, the ship is subjected to entirely different conditions ; at both bow and stern there is an excess of buoyancy of about 690 tons, and amidships an excess of weight of 1380 tons. Throughout the length sagging strains have to be resisted ; and the maximum sagging moment, borne by a transverse section near the middle of the length, is about 74,800 foot-tons.

Ships of the *Devastation* type gain upon the *Minotaur* class when placed upon the wave crest, because the added buoyancy amidships is well situated in relation to the concentrated weights there placed. Hogging moments are then experienced throughout the length, but they are of moderate amount. When the *Devastation* floats on a wave of her own length (300 feet by 20 feet high)—a proportionately steeper wave than that assumed for the *Minotaur*—the weight and buoyancy are distributed as follows : First 37 feet from the bow, weight 130 tons in excess ; next 34 feet, buoyancy 90 tons in excess ; next 35 feet (under fore turret), weight 580 tons in excess ; next 84 feet (in wake of wave crest), buoyancy 940 tons in excess ; next 22 feet, weight (under after turret) 160 tons in excess ; next 37 feet, buoyancy 260 tons in excess ; and thence to the stern, weight 420 tons in excess. This case is more complicated than that of the *Minotaur* type, just as it has been shown to be in still water. But the resultant bending moments are far less severe ; the maximum hogging moment amidships in the *Devastation* is only one-fourth (36,800 foot-tons) that in the *Minotaur*.

The most critical case for the *Devastation* type is that when the ship lies astride a wave hollow. The substitution of the wave profile for the horizontal surface of still water exaggerates the excesses of weight amidships, while the immersion of the extremities in the wave slopes decreases or does away with any excess of weight existing there in still water. The lowness of the freeboard in the *Devastation* helps the ship in this critical position ; the wave slopes cover the extremities of the upper deck, the ship sinking bodily deeper into the wave than if she had a lofty bow and stern like the *Minotaur* ; consequently there are less excesses of buoyancy at the extremities, as well as less sagging moments amidships. The actual distribution of the weight and buoyancy in this position may be summarized as follows : The first 80 feet of length from the bow, buoyancy 920 tons in excess ; the first 95 feet of length from the stern, buoyancy 880 tons in excess ; on the midship length of about 135 feet, weight 1800 tons in excess. These are considerable quantities, but, com-

pared with the corresponding figures for the *Minotaur* on a wave crest, they appear moderate. The resultant maximum sagging moments in the *Devastation*, experienced by a section near the middle of the length, is 51,000 foot-tons; about *two-thirds* the corresponding sagging moment for the *Minotaur*, and a little over *one-third* the maximum hogging moment for that ship.

It has been previously remarked that the fairest comparison is that which expresses the bending moments as a fraction of the product of the weight (W tons) into the length (L feet). A summary of the foregoing remarks is given in the following table:—

Maximum bending moment.	<i>Minotaur.</i>	<i>Devastation.</i>
On wave crest—hogging	$\frac{1}{8} \times W \times L$	$\frac{1}{11} \times W \times L$
In wave hollow—sagging	$\frac{1}{8} \times W \times L$	$\frac{1}{11} \times W \times L$
In still water	$\frac{1}{8} \times W \times L$ (Hogging)	$\frac{1}{8} \times W \times L$ (Sagging)

Allusion has been made to the great rapidity and magnitude of the changes of strain to which ships are liable in a seaway, and the statement may now be illustrated. From the time that the *Minotaur* occupies the position shown in Fig. 113 to the instant when she may lie across the hollow as in Fig. 114 will be an interval of only $4\frac{1}{2}$ seconds; the straining actions at the commencement of that brief interval tend to hog the ship with a moment of 140,000 foot-tons, while at its end their character has undergone a complete change, and they produce a sagging moment of 74,800 foot-tons. The sum of these quantities—say 215,000 foot-tons—may be taken as a measure of the change of bending moment occurring about once in every $4\frac{1}{2}$ seconds. In the *Devastation*, owing to her less length, the time interval between the two extreme positions will be less than 4 seconds; the bending moment changing from 37,000 foot-tons (hogging) to 51,000 foot-tons (sagging), the sum of the two being about 88,000 foot-tons, or considerably below one-half the corresponding sum in the *Minotaur*. As between the two ships, the difference is very important; but it will be understood that the present intention is rather to deal with types and general principles than with particular ships. These principles apply, moreover, with equal force to unarmoured vessels of war or to non-combatant vessels.

In the following table have been grouped the results of a number of calculations for the bending moments of different classes of ships. The waves assumed in each case have had lengths equal to the

Description of ship.	Waves assumed in calculations.		Maximum bending moments = weight × length ÷ the numbers below.			Condition of loading represented by calculations.	Authority.
	Length.	Height.	Still water.	Wave crest.	Wave hollow.		
Armoured war-ships—							
1. First-class battle-ship, barbette armament (<i>Royal Sovereign</i> type)	380	24	297.0	39.3	51.0	Fully laden	The author.
2. Broadside ironclad, with water-line belt and central battery (<i>Bellerophon</i> type)	300	20	176.0	45.5	43.0	"	Sir E. J. Reed.
3. Broadside ironclad, with water-line belt and two-storied central battery (<i>Jarvis</i> type)	280	18	—297.0	70.0	38.0	"	The author.
4. Turret-ram, single turret in battery (<i>Rupert</i> type)	256	17	253.0	43.0	41.0	"	"
5. Belted cruiser, with armoured screens to chase guns (<i>Shannon</i> type)	270	18	—121.0	33.0	67.0	"	"
6. Central citadel, with under-water deck at ends (<i>Aior</i> type).	300	18	79.0	146.0	30.0	"	"
Unarmoured and protected ships—							
7. Royal yacht (<i>Victoria and Albert</i>) paddle-wheel, high speed	300	30	139.0	43.0	23.0	"	Sir E. J. Reed.
8. First-class cruiser, with protective deck (<i>Blake</i> type).	375	24	100.0	33.4	65.0	"	The author.
9. Twin-screw despatch vessel (<i>Iris</i> type)	300	15	58.0	29.0	—	"	"
10. Torpedo gunboat	330	11½	87.0	23.3	34.0	"	"
11. Torpedo boat-destroyer	180	9½	165.5	30.0	20.5	"	"
12. Second-class torpedo-boat	—	—	—1060.0	—	—	"	Mr. Thornycroft.
Merchant ships—							
1. Transatlantic passenger-steamer	492	24½	122.0	32.0	46.0	Homogeneous cargo, normal	M. Plaud.
2. Passenger and cargo steamer, 15 knots sea speed	350	17½	—	24.4	117.7	Homogeneous cargo, bunkers empty on crest and full in hollow	Mr. A. Denny.
3. Cargo steamer, ordinary type, 10 knots sea speed	350	17½	—	29.7	91.8	"	"
4. Cargo steamer, ordinary type, at light draught	360	16	117.0	26.0	33.0	As on ordinary service	Mr. Rundell.
5. Passenger and cargo steamer, at load draught	360	16	109.0	37.0	83.0	Homogeneous cargo	The author.
6. Cargo steamer, ordinary type, awning-deck type	360	18	158.0	37.0	43.0	As on ordinary service	Mr. John.
7. Cargo steamer, ordinary type	336	12	—	35.0	50.0	Homogeneous cargo	M. Plaud.
8. Spar-deck type	348	17½	186.0	36.0	50.6	Homogeneous cargo, bunkers full	Mr. Bergstrom.
9. Well-deck type	290	20	238.0	37.6	39.7	Homogeneous cargo, bunkers empty	"
10. " "	290	20	—	27.8	55.7	Cargo of iron ore	"
11. " "	290	20	—	120.0	21.5	Oil in bulk, principally stowed amidships	Mr. Kendal.
12. Oil-carrying steamer, shade-deck type	345	16	70.4	137.4	34.4	Homogeneous cargo	Mr. John.
13. Light-draught river steamer (<i>Mary</i>) on ocean voyage	210	7	—70.0	37.0	17.0	"	M. Plaud.
14. Stern-wheel river steamer	—	—	—	—	—	"	"
15. Sailing vessel, normal cargo	228	11½	—	36.6	271.5	"	"

NOTE.—The negative sign in the column for still-water bending indicates a sagging moment; in all other cases hogging moments have the maximum values. On wave crests hogging moments are universal; in the wave hollows sagging moments.

lengths of the ships ; but it will be observed that the ratio of heights to lengths of waves differ considerably in the various examples, thus rendering an exact comparison impossible. Apart from such a comparison, however, the figures have an interest as illustrations of the singular differences existing between the character and magnitude of the still-water bending moments of various types of ships, and the contrast between those still-water strains for a particular ship, and the strains on a wave crest, or astride a wave hollow. For sea-going ships, so far as can be seen at present, the maximum bending moment (in foot-tons) is likely to fall below *one-twentieth* of the product of the weight of the ship into her length, if the ratio of height to length assumed for the waves does not exceed 1 to 15. Cases may be met with where the maximum bending moment, estimated in the manner described, may exceed the limit named, because of some exceptionally trying distribution of the load ; and it is very difficult to assign the worst possible conditions of lading to any merchant ship. From the remarks which follow, it will be seen that there are many conditions tending to make the bending moments actually experienced by ships among waves less than those estimated on the ordinary assumptions.

For purposes of comparison, the method of calculating bending moments for ships among waves above described is generally adopted, although it is recognized that the assumptions made omit the consideration of many circumstances which sensibly affect the strains actually experienced by ships. Attempts have been made to introduce corrections for some of these omissions, and to approximate to the actual values of longitudinal bending moments. From the nature of the case, only approximations are possible ; it may be of interest, however, to briefly describe the directions in which estimates made on the ordinary method must be modified in practice.

In Chapter V. the internal structure of ocean waves has been described, and the influence of wave motion upon fluid pressure has been discussed. Fig. 80, p. 198, illustrates the wave structure, and indicates the positions of the subsurfaces of equal pressure in the wave as well as the corresponding subsurfaces in still water. A study of that diagram will show that if any point be taken in the wave water forming the *upper half of the wave*, the pressure will be *less* than that at a point which in still water is situated at an equal depth below the surface. Further, for any point in the *lower half of the wave* the pressure will be *greater* than that at a point which is situated at an equal depth below the surface of still water. Consequently those cross-sections of a ship which are immersed at any moment in the upper half of the wave will contribute less buoyancy than is assigned to them by the ordinary assumptions, while those

cross-sections which are immersed in the lower half of the wave will contribute more buoyancy. This follows from the fact that in the ordinary method of calculation the pressure at any point on the bottom of the ship is estimated, as for still water, by the weight of a vertical column of water reaching to the surface; whereas in the wave the accelerations accompanying orbital motions of the particles of water must be compounded with the action of gravity. Applying these considerations to the typical positions illustrated by Figs. 113 and 114, it will be seen that the following corrections are required. On the wave crest, the ordinary method over-estimates the excess of buoyancy amidships and the defects of buoyancy at the extremities, with the result that the hogging moments are over-estimated. In the wave hollow, that method over-estimates the excesses of buoyancy at the extremities and the defect of buoyancy amidships, and so produces a sagging moment in excess of the actual amounts. For both positions, therefore, the bending moment must be reduced if allowance is made for the conditions of fluid-pressure in the wave. Quantitative results obtained for certain typical ships show that this correction may be considerable.* For example, in a vessel of fine form at the extremities, with the buoyancy concentrated amidships, the hogging moment by the corrected method was only 77 per cent. of that obtained by the ordinary method, and the sagging moment was only 55 per cent. The relative value of this correction obviously increases as the draughts of ships increase, and they penetrate further into the wave structure. Its value will also be influenced by the degree of fineness of form and by other circumstances. In all cases, however, it is of great practical importance.

Longitudinal bending moments among waves are also affected by the vertical oscillations—heaving and dipping—described on p. 273, of which the ordinary method of calculation takes no account. If the amplitude and period of these oscillations were known, it would be possible to estimate the variation in “virtual weight” of the ship, and to ascertain how that variation affected the bending moments. Further, it would be possible to trace the vertical position of the centre of gravity of the ship, and to determine how that point is situated in relation to the positions which would give statical equilibrium when the ship is balanced on the wave crest or astride the wave hollow. The critical cases to be considered are those when the heaving and dipping oscillations cause the widest departures of the centre of gravity

* In a paper by Mr. W. E. Smith, published in the *Transactions* of the Institution of Naval Architects for 1883, this matter was first investigated, and the facts for typical ships are drawn from that source.

from the vertical positions on the wave crest or in the wave hollow which would correspond to statical equilibrium. An able investigation has recently been made of the probable extent of these departures.* The results, while confessedly approximate, are remarkable. It is estimated that a ship 380 feet long, and of 7800 tons displacement, heaving and dipping among waves of her own length, which have an "apparent period" of rather less than 6 seconds, might have her centre of gravity raised more than 9 feet above the position corresponding to statical equilibrium on the wave crest; and depressed about $8\frac{1}{2}$ feet from the position corresponding to statical equilibrium in the wave hollow. These maximum excursions from the positions of statical equilibrium would only be gradually attained, and would alternate with less values, having minima which practically approach coincidence with the positions of statical equilibrium. Taking the two extreme positions, it appears that for a ship poised on the wave crest the departure from statical equilibrium usually results in a diminution of the hogging moments obtained when vertical oscillations are disregarded; whereas in the wave hollow the depression of the centre of gravity below the position of statical equilibrium involves an increase in sagging moments. In the example above mentioned it has been calculated that the decrease in hogging moments might be more than 7 per cent., and the increase in sagging moments more than 20 per cent. Under most conditions of lading for ordinary cargo-carriers, the hogging moments are more severe than the sagging moments; so that the reduction in the hogging moments produced by vertical oscillations is favourable to the structure of a ship in its resistance to what are ordinarily the severest bending strains.

The ordinary method of estimating the longitudinal bending moments for ships among waves omits from consideration the pitching and 'scending motions which generally occur when ships are placed end-on to waves of the assumed dimensions. The influence of these longitudinal oscillations upon bending moments depends upon many varying conditions, such as the under-water form of a ship, and the longitudinal distribution of the fluid resistance to her oscillation, the stowage of the cargo, the period and amplitude of the oscillations. Obviously these longitudinal oscillations give rise to variations in the relative distribution of weight and buoyancy additional to the influence of the passage of wave profiles. At one instant the bow may be buried deeply in the wave slope, and soon after emerged to a great extent. Furthermore, except when the

* See Mr. Read's paper in the *Transactions* of the Institution of Naval Architects for 1890.

extremes of oscillation are reached, the fluid resistance to pitching brings into play upon the ship reactions which must sensibly affect the bending moment. Accelerating forces are also operating, attaining their maxima when the ship reaches the extreme of an oscillation. The magnitude of these forces increases as the amplitude of the oscillation increases and as the period of oscillation decreases. A quick-moving ship is likely to be more strained in pitching through a given arc than a slow-moving ship, and there must be greater frequency of action of the maximum straining forces. The stowage of cargo influences the period of pitching, and also the effect of pitching on the bending moment at any cross-section. At the midship section of a ship, where the maximum bending moments occur when she is among waves, pitching and 'scending motions, supposing them unresisted, would have no influence on the bending moments if the weights of ship and lading were so distributed that the moments of inertia of the fore body and of the after body about the middle of the length were equal.* When the moments of inertia of the two bodies are unequal, the bending moment will be alternately greater and less than the value obtained on the hypothesis of statical equilibrium. This general statement must suffice respecting the influence of pitching upon longitudinal bending moments. Experience shows that influence to be often considerable and important, but our information is very imperfect on many of the conditions involved, and consequently exact estimates cannot be made.

Rolling and pitching often occur simultaneously in a ship among waves, and her structure is subjected to longitudinal bending strains when she is considerably inclined to the upright. It has been explained that the foregoing estimates for longitudinal bending moments assume that the vessel remains upright. Inclinations from the upright, however, must necessarily affect the distribution of the buoyancy along the length of a ship, and so will influence the bending moment. For any assigned inclination of a ship the necessary calculations can be readily made; but they are rarely undertaken, and have little practical importance. It is worthy of note that the hypothetical cases in Figs. 113 and 114 represent a ship bow-on to the waves, the position in which she is likely to roll comparatively little. On the other hand, if she is broad-side-on, or nearly so, to the waves, and rolls considerably in consequence, the wave form occupies a position relatively to her length less likely to cause such unequal distribution of the weight and buoyancy as is assumed in Figs. 113 and 114. When the ship lies obliquely to the waves, another kind of strain is developed con-

* For the proof of this, see Mr. Read's paper cited above.

currently with longitudinal bending, viz. the *twisting* tendency, produced when the bow is lying on the slope of one wave and the stern on that of the next wave, the fore and after parts of the ship being subject to forces tending to heel them in opposite directions. These are matters which influence the structural arrangements in a degree subordinate to that of the considerations which have received most attention in this chapter; and they are mentioned here chiefly because in the following chapter some notice will be taken of the manner in which the shipbuilder provides strength to resist them.

Longitudinal Bending Moments in Ships ashore.—The best authorities at present agree in taking the exceptional positions illustrated in Figs. 113 and 114 as affording fair comparative measures of the maximum longitudinal bending strains experienced by ships. Some writers, including the late Sir W. Fairbairn, have, however, suggested the propriety of giving to all ships strength sufficient to resist the far more severe bending strains produced when vessels are aground and supported only at the middle of the length, or at the ends. The advantage of adopting such a standard may well be questioned, seeing that the theoretical conditions of support—viz. concentration of the support at *points* along the length—are never likely to be fulfilled, and rarely, if ever, approximated to. Many ships have grounded, no doubt, and rested either at the middle part only or else only at the ends; but a certain distribution of the support has even then been secured, and in nearly all such cases the vessels have remained partially water-borne. Moreover, accidents of this kind are of rare occurrence to any ship, and are entirely escaped by the great majority of vessels; besides which it must be remembered that failure or serious damage in grounding, etc., is far more likely to result from excessive *local* strains than from bending strains experienced by the ship as a whole. The bottoms of ships crush up, or are much damaged, very frequently before the structural strength against bending strains is over-tasked. On the whole, therefore, the generally accepted method which deals with ships *afloat* appears very much superior to the alternative proposal, based upon the condition of ships ashore. There are a vast number of ships which have been many years afloat on active service, and have displayed no signs of weakness, which would utterly fail under the conditions which Sir W. Fairbairn and others would have imposed; for it appears that, in the extreme cases of support ashore, the maximum bending strains reach from four to six times the maximum strains incidental to the extreme cases of support amongst waves. In some of these vessels, no doubt, the best distribution of material has not been made, and much greater longitudinal

strength might have been secured by improved arrangements without increase in the total weights of hull; but in most cases it would appear an unnecessary and uneconomical plan to provide a large reserve of strength to meet a contingency that may never be encountered, and which would necessitate heavier hulls and decreased carrying power.

Only a few cases can be given, from the many that might be quoted, where vessels have grounded in a tideway and been left unsupported for considerable parts of their lengths, or have stopped in launching and been suspended in exceptional positions. The well-known case of the *Northumberland*, which stopped on the launching ways at Millwall in 1866, and remained for a month with one-eighth of her length unsupported, may be mentioned, because it has been thoroughly investigated; even this exceptional position did not develop such severe bending strains as would result from suspension on the wave crest. Had the ship been supported only at the middle, the case would have been very different; as it was, the ship maintained her form unchanged. A similar and more recent case is that of H.M.S. *Neptune*, which stopped on the launching ways; her bottom crushed up, owing to the concentration of the support near the middle of the length, but the sheer was unbroken, and no serious damage done to the structure. Very different from the condition of these iron ships was that of the wood line-of-battle ship *Cæsar*, which stopped in launching at Pembroke in 1853, and remained a fortnight with 64 feet of the stern unsupported by the ways; her stern dropping no less than 2 feet in 90 feet. As a converse case, we may refer to the *Prince of Wales*, an iron steamer, which was left for some time, owing to an accident, supported at the ends only, her bow on the edge of a wharf, and her stern in the water; she also was uninjured. The case of H.M.S. *Howe* is both recent and remarkable. For five months she was aground on the Pereiro reef at Ferrol, supported only for about 100 feet of her length, and inclined about 20 degrees to the vertical. Her bottom from the bilge to the keel was seriously crushed under the great local strains; but the structure as a whole sustained no permanent change of form, either in the longitudinal or the transverse sense. In none of these instances were the extreme conditions of suspension at the ends or middle realized, nor are they likely to be so.

Strains tending to produce Change in Transverse Form.—The most severe transverse bending likely to be experienced by a ship at rest is that resulting from grounding or being docked. Fig. 115 will illustrate this case. Suppose the vessel, for a time, to be wholly supported on her keel; then the blocks or the ground must furnish an upward pressure to balance the total weight of ship and lading

and this is indicated in the diagram by $2W$ acting vertically. Considering each side of the ship to bear an equal load, the total of hull and lading for one side of the ship is W , a downward pressure

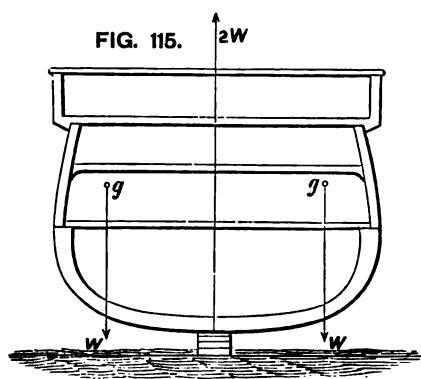

acting through g , the centre of gravity of that side. The transverse distance of g from the longitudinal middle plane of the ship depends, of course, on the distribution, in a transverse sense, of the weights carried. If these weights are placed centrally, g will lie much nearer to the middle plane than if the weights are "winged"—carried far away from the middle. For instance, in an armoured ship several hundred tons of armour may be carried on the broadside, and a great weight of coal in the wings; in which case g will lie far out. On the other hand, a merchant ship may have her cargo—say of rails or heavy materials—stowed almost at the centre, along over the keel; in which case g will lie near the middle plane. When the distribution of the weights is known, the position of g can be determined; the transverse bending moment will (under the conditions assumed) equal the product of W into the distance of g from the middle plane. This moment tends to make the bilges drop relatively to the middle, and to break off the ribs of the ship at the middle line, but before actual deformation takes place the deck beams and plating on the decks must be brought into tension, and will effectually assist the lower parts of the structure in resisting change of form.

This is an extreme case, not often realized perhaps, but sometimes occurring. A ship left aground by the retreating tide is either likely to remain partially water-borne or else, when left high and dry, she will "loll" over and rest on one of her bilges as well as on the keel. A ship, when docked, is generally supported by shores as the water leaves her; so that the upward pressure from the blocks is not equal to the total weight, nor is the transverse bending moment nearly so severe when the shores under the bilges and bottom take part of the weight, and the "breast shores" assist in maintaining form. It is, however, certain that ships in dock, especially wood-built ironclad ships, require to be very carefully supported by shores, in order to prevent changes of transverse form; and many cases are on record where such changes have actually

taken place. The converted ironclads of the Royal Navy, for example, were found to “break” transversely when in dock, even when well shored; and it was suggested to use bilge-blocks in order to lessen the strains. Such blocks have been used for this purpose, both in this country and abroad, in vessels of unusual form. The American monitors were thus supported when in dock; and the flat-bottomed floating batteries built for the Royal Navy during the Crimean War were docked on bilge as well as central blocks. The reduction of transverse bending strains by these special supports is easily explained; for instead of an upward pressure W at the middle line and the downward force W forming a couple, the resultant of the pressure on the keel-blocks and bilge-blocks will necessarily lie some distance out from the middle and closer to the line of action of the downward force W .

Ships afloat and at rest in still water are not usually strained so severely as vessels supported on the keel only; for a reason very similar to that just given.

Fig. 116 illustrates this case. Taking one-half the ship separately, its weight W acts through g , as before explained; but the support W is now furnished by the buoyancy of that half of the ship acting upwards through b , the centre of buoyancy for that half. Probably the case illustrated in the diagram is the most

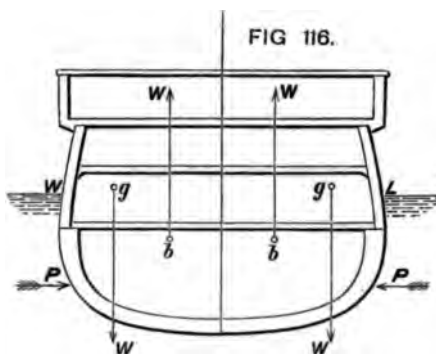

common, g lying further from the middle than b ; but in some ships with great weights of cargo stowed centrally over the keel, it is conceivable that the relative positions of g and b may be reversed, g lying nearer to the middle of the ship.

The horizontal fluid pressures also contribute towards producing changes of transverse form. The pressures P, P in Fig. 116 are equal and opposite when the ship is at rest, but she tends to become compressed by the equal and opposite pressures. This is a parallel case to that given before for longitudinal bending strains; only here the pressures are much greater than for longitudinal strains. For example, in the *Minotaur* the longitudinal pressures amount to about 400 tons, whereas the transverse pressures would amount to about 3500 tons. The transverse pressures P, P may be considered to act along lines at a depth below water equal to about two-thirds of the mean draught when the ship is upright. When she is inclined, similar, but possibly more severe, compressive strains will be caused

by the fluid pressures, the tendency being to force the bilges inwards, and thus to distort the transverse form.

The most marked indications of these compressive strains are usually to be found near the extremities, where the sides are flat and nearly upright. Many instances have been noted where "panting," as it is termed, has taken place in those parts of badly constructed ships, the sides moving in and out under varying conditions. Such changes of form are, however, very easily prevented by simple structural arrangements, as will be shown further on.

Rolling oscillations lead to a great increase in the forces tending to alter the transverse forms of ships. This will be obvious, from the remarks previously made respecting the accelerating forces developed during rolling, and the changes in magnitude and direction which these forces undergo during the motion. When the period and range of the oscillation are known, and the conditions of statical stability have been ascertained for the ship, it is possible to approximate to the racking strains produced by the accelerating forces; but their general character can be understood apart from

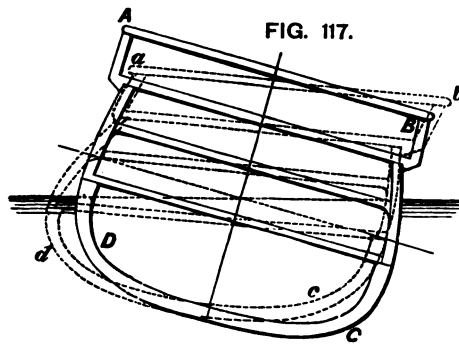

calculation. Referring to Fig. 117, the cross-section of a ship will be seen in an inclined position, representing the extreme angle of heel attained when rolling. When the motion ceases, the accelerating forces reach their maximum value, and their straining effect is greatest. This straining action tends to distort the

form of the transverse section as indicated in a greatly exaggerated form, by dotted lines, changing it from ABCD (*drawn* lines) to *abcd* (*dotted* lines). At the angle B there is a tendency to make the inclination of the deck to the side an *acute* angle; on the opposite side, at A, there is a tendency to make the corresponding angle *obtuse*. At the bilges corresponding changes are indicated; the general character of the change may be described as resulting from the tendency of the parts to keep moving on in the direction in which they were moving before the maximum heel was reached. Experience fully confirms the theoretical deduction, that rolling motion develops straining forces tending to change the angles made by the decks with the sides. In wood ships, working at the beam-arms was very common during heavy rolling at sea. Beam-knee fastenings worked

loose, and other indications of strain or working occurred. At the bilges also in wood-built steamships, working sometimes took place during rolling, and unless precautions were taken, pipes, etc., were broken at the joints, or disturbed by the change of form; in fact, the attention that has been bestowed by practical shipbuilders upon beam-knees and other fastenings intended to secure rigidity of transverse form can scarcely be paralleled from any other part of the structure.

The racking strains produced by rolling have their effect greatly enhanced by the changes in direction and intensity occurring during each oscillation; and hence it is that the range of oscillation as well as the period are such important elements in a comparison of the transverse racking strains experienced by two ships. Allusion has already been made to this in discussing the behaviour of ships at sea, but it is desirable to further illustrate the matter, and for this purpose it is necessary to make use of an approximate rule for the maximum value of these racking strains. The late Professor Rankine proposed such an approximate rule, as follows:—

$$\text{Moment of racking forces} = \frac{D^2}{D^2 + B^2} \times \left\{ \begin{array}{l} \text{righting moment for maxi-} \\ \text{mum heel attained,} \end{array} \right.$$

where D = total depth of ship from upper deck to keel,

B = breadth of ship.

Applying this rule to two typical ships, one having a short period like the *Prince Consort* class, and another having a long period like the *Hercules* class, a remarkable contrast becomes apparent. Actual observations show that the *Hercules* only rolled 15 degrees on each side of the upright when a converted ironclad was rolling 30 degrees each way. Suppose these figures to be used. For these two vessels, the respective values of B and D are approximately equal, the

ratio $\frac{D^2}{B^2 + D^2}$ being about 1 to 3 for each ship. Assuming this ratio

to be used, it is found that the moment of racking forces at the extreme of the heavy roll of the *Prince Consort* would be about 7000 foot-tons, and the corresponding moment at the extreme of the moderate heel of the *Hercules* would be about one-third as great. The *Prince Consort* had a period of about 5 seconds; consequently, twelve times every minute a racking moment of the amount stated will be acting upon her structure, and at intervals of 5 seconds the distortion will tend to take place in opposite directions. In the *Hercules*, with a period of about 8 seconds, a racking moment less than one-third the amount of that in the *Prince Consort* will be acting only seven times every minute, and the tendency to distort will change its direction at intervals of about 8 seconds. The less

frequent change of strain and the diminished moment tell greatly in favour of the slower-moving and steadier ship. What has here been shown to hold good for particular ships holds good also for ships in general. Lengthening the period of still-water oscillations not merely makes ships steadier in a seaway, but greatly reduces the effect of strains tending to produce changes in the transverse forms, or damage to the masts and rigging. Deep-rolling ships are also the quickest in their motions, and require the greatest strength in hull and equipment.

Hitherto investigations of the forces tending to produce changes of transverse form in ships have been, for the most part, of a qualitative character. Estimates of the magnitude of these forces in different classes of ships are almost entirely wanting; and *data* are not available for transverse strains, similar to the figures for longitudinal bending moments given in the foregoing table. Probably greater attention might, with advantage, be given to the consideration of transverse strains, and it is to be hoped that the subject will receive the fuller consideration it deserves now that the character and amount of longitudinal bending moments have been investigated.*

Strains incidental to Propulsion.—Little can be said respecting the strains produced by the propelling apparatus upon the structure of a ship considered as a whole, although this third class of strains is by no means unimportant. When a ship is propelled by sails, the effective wind pressure may be resolved into two parts: one acting longitudinally and constituting a "thrust" which propels the vessel on her course; the other acting transversely, producing leeway and an angle of steady heel. When the motion of the vessel is uniform, the longitudinal thrust exactly balances the fluid resistance to the motion ahead; the thrust and resistance form a mechanical couple; and the "centre of effort" of the sails, where the resultant thrust may be supposed to be delivered, will be at a great height above the line of action of the fluid resistance. This couple by its action must produce two effects on the ship: first, a change of trim—deeper immersion by the bow—corresponding to its moment; † second, a longitudinal racking action upon the structure of the ship. The character of this racking action may be simply illustrated by taking a rectangular frame formed of four pieces of wood, joined to one

* An interesting paper on this subject, by Messrs. Read and Jenkins, appears in vol. 23 of the *Transactions* of the Institution of Naval Architects.

† For the principles upon which the calculation of this trim would be based, see Chapter III.; for a discussion of propulsion by sails, see Chapter XII.

another at the angles, and supposing either pair of its parallel sides to be acted upon by forces equal in magnitude, but opposite in direction. Obviously, the rectangle would become distorted into a rhomboid, unless the connections were very strong; but by means of a diagonal tie, like that on an ordinary field-gate, this racking or change of form may be very easily prevented. The corresponding tendency in ships is also unimportant, because of the large reserve of structural strength to resist such strains.

Similar considerations hold good for the strains produced by the transverse component of the wind pressure. When the drift to leeward has become uniform the fluid resistance will supply a lateral resistance (P in Fig. 118) equal and opposite to the transverse component of the wind pressure. Under the action of this couple the vessel will heel steadily to an angle for which the righting moment equals the moment of the inclining couple. At the same time a transverse racking strain will be brought into action on the structure of the ship. The shrouds on the weather side will be taut, and have a tension (T , Fig. 118) brought upon them, which tension will be governed by the force of the wind pressure (P), the angle of heel of the ship, the overhanging weight of the masts, rigging, and sails, the angle between the shrouds and the mast, and the stiffness of the mast to resist deflection under pressure. This tension also gives rise to a thrust delivered by the mast upon its step (Q , Fig. 118); and the united action of these forces tends to produce an alteration in the transverse form. Professor Rankine estimated the probable maximum bending moment of these forces at one-half the moment of statical stability corresponding to the angle of steady heel; and if this estimate be accepted, as it is reasonable to do, it will be seen that the transverse racking moment for a steady pressure of wind is so small in amount as to be practically unimportant in its effect upon the ship considered as a whole. If the wind acts on the sails in gusts or squalls the straining effect will be much increased; and when to this irregular action of the

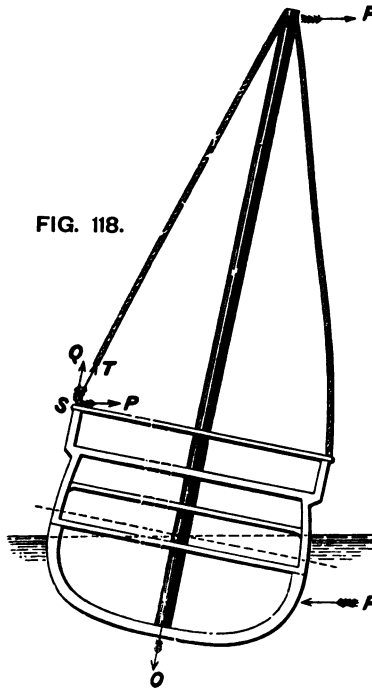

FIG. 118.

wind is added the influence of the accelerating forces incidental to the rolling or lurching of ships among waves, it is evident that great and variable strains may be brought upon the structure of a sailing ship, of which the amounts are not easily ascertainable. Experience proves, however, that when damage occurs under these circumstances it is usually of a *local* character: as, for example, a failure in the connections of the shrouds to the ship at the channels and chain-plates, or a disturbance of the deck near the wedging to the masts. With these local strains we are not at present concerned.

With steam as the propelling agent, the case is simpler than with sails. The thrust of the propeller will usually be delivered in the direction of the course of the ship, and will therefore have no transverse component; moreover, the line of action of that thrust will lie very much closer than it does with sail power to the line of action of the fluid resistance. When the screw is employed, the line of thrust for the propeller approximates to coincidence with the line of action of the resistance; and when paddles, or jet propellers, are used, the thrust is delivered at a comparatively small height above the line of action of the resultant resistance. Considered as a whole, the structures of steamships are usually but little strained by the propelling apparatus.

Vibration of Steamships.—In this connection allusion may be made to a subject of great practical importance—the *vibration* of steamships. It is well known that in some vessels, when the engines are running at certain rates of revolution, more or less troublesome vibration occurs, even in smooth water and when the propellers are well immersed. With small swift vessels, such as torpedo-boats and torpedo-gunboats, propelled by quick-running engines, the phenomena of vibration are most marked; but they also occur occasionally in vessels of the largest size and with engines making a much less number of revolutions per minute. A large number of experiments and careful observations have proved that the chief cause of such vibrations is to be found in the unbalanced moving parts of the propelling machinery which perform reciprocatory movements, and so alternately impress upon the vessel upward, downward, or lateral momentum.* So far as vibration is concerned, a ship may be compared to a bar of varying cross-section; and its natural period of vibration depends upon the structural arrangements

* See on this subject papers in the *Transactions* of the Institution of Naval Architects by the following writers: Mr. Schlick, in vols. 25 and 34; Mr. Yarrow and the author in vol. 33. Mr. Yarrow's

paper is of special interest; and the remarks by Mr. Mallock thereon represent the opinion of an observer who has made a special study of the subject.

and distribution of the material. If the rate of revolution of the engines approximates to multiples of this period of vibration, then the successive impulses, due to the unbalanced moving parts, gradually increase the extent of the vibratory movements. If, on the other hand, the engines are running at rates not approximating to synchronism with multiples of the period of the vibrations, their extent will be much reduced. Experience shows that a moderate change in the number of revolutions of the engines may produce very sensible differences in vibration. When the natural period of vibration of the hull has been approximately determined, it is advantageous to choose propellers which will give the speeds most frequently required, at rates of revolution not approximating to multiples of the period of vibration. In many cases a change of propellers has resulted in a lessening or disappearance of vibration at the full speeds of steamers. Hence has arisen the belief that the propellers, especially in screw-steamships, were the chief cause of vibration. While badly designed propellers may assist in producing vibration, and propellers not well immersed or (under certain conditions) propellers which are well immersed, may also do so, yet as a rule the action of the propellers does not much affect the result. Mr. Yarrow has made most interesting experiments on torpedo-boats. In one series the engines were run at the critical speeds producing large vibration with the propellers on, and afterwards with the propellers removed. The results were practically identical. By careful balancing of the moving parts of the engines, Mr. Yarrow afterwards succeeded in preventing sensible vibration, even at these critical speeds.

When a ship vibrates, there are some positions where the motion has maximum values and others where there is no motion. The latter points are termed "nodes," their number changing with the rate of revolution of the engines. Two nodes occur when the vibration is the slowest. Mr. Mallock is of opinion that the engines of ships very rarely run fast enough to cause four nodes; and that in large ships three nodes may occur at the highest speeds of engines which cause sensible vibration.

While balancing the moving parts of engines cannot fail to be advantageous, it is not usually necessary, and has been carried out thoroughly in few cases. Besides this, which is no doubt the prime remedy for troublesome vibration, experience shows that other details may have a sensible influence. The longitudinal positions in which the engines are placed may have an important effect on vibration: bearers, stays, etc., in the engine-room should be carefully arranged. Discontinuity of strength should be avoided. Individual parts of the structure should be made to lend mutual succour. Local movements

produced by vibration may often be corrected by stays, partial bulkheads, or longitudinal stiffness.

It has been urged that vibration is a result of structural weakness, or extremely light scantlings. Experience shows, however, that this is not true. Very heavily built ships have suffered from excessive vibration at certain speeds of engine. Sister ships have been tried, in one of which special stiffening girders have been fitted to decks and bottoms, in order to give greater rigidity, and to diminish vibration; but the latter result has not been attained. Cases may occur, in fact, where additional strength and rigidity may so change the period of natural vibration in the structure as to tend to increase rather than to reduce vibration at the maximum speeds of the engines. On this subject a considerable amount of experimental data has already been obtained, and further observations are in progress.

Local Strains.—The last class of strains to be considered are those grouped under the head of *local strains*. Of these, there is such a great number and variety that an exhaustive treatment of the subject will scarcely be found in works on shipbuilding; and all that can be done in the present sketch is to select a few of the principal types, indicating the causes and character of the strains. As a matter of convenience, we shall adjoin, in each case, a brief account of the arrangements by which the strain is prevented from producing local damage or failure.

At the outset it may be well to note that the same circumstances which have already been mentioned as producing strains upon a ship considered as a whole may and do produce severe local strains. For example, a heavy load concentrated in a short length, not merely contributes to the longitudinal bending moment previously described, but also tends to push outwards that part of the bottom upon which it rests. Similarly, the thrust of a screw propeller not only tends to rack the ship as a whole, but produces considerable local strain on that part of the ship to which the "thrust-bearer" is attached. Again, the downward thrust of a mast, besides tending to alter the transverse form of the ship as a whole, produces a considerable local strain on the step, and on the frames of the ship which carry the step. And these are only a few illustrations of a general principle. When the ship is treated as a whole, it is virtually assumed that these local strains have been provided against; so that the various parts of the structure can act together and lend mutual assistance. As a matter of fact, however, it is not at all uncommon to find local failure supervening long before the limit of the strength of a ship considered as a whole has been realised. The case of the *Neptune*, previously quoted, well illustrates this; when she stopped in

launching, her general structural strength was ample even against the severe bending moments experienced; but while her longitudinal form remained almost unchanged, the very exceptional local strains on a small portion of the bottom forced it inwards, disturbing the decks, etc., above it.

One of the chief causes of local straining has already been mentioned; viz. a great concentration of loads at certain parts of a ship; and the converse case is also important—that where there is a great excess of buoyancy on a short length. Examples have been given of such concentration of loads; one of the most notable is that for the *Devastation*, in wake of the turrets (see Fig. 109), where there is an excess of weight over buoyancy 550 tons on a length of about 30 feet. Still more concentrated is the load of armour on a battery bulkhead, weighing perhaps 100 tons, and lying athwartships. Immediately in wake of such concentrated loads the bottom tends to move outwards from its true shape; the local strain which is developed tending to produce simultaneously both longitudinal and transverse change of form. Many similar causes of straining will occur to the reader; it is only necessary to mention the cases of a vessel with a heavy cargo, like railway iron, stowed compactly, or of a vessel with heavy machinery carried on a short length of the ship, or of the parts adjacent to the mast step of a sailing ship.

Surplus buoyancy on a ship afloat is not usually found so much concentrated as surplus weight; but in some instances the excess of buoyancy produces a considerable local strain tending to force the bottom upwards for a portion of the length. Lateral pressures as well as vertical pressures require to be provided against, especially near the extremities of ships.

To prevent local deformations of the bottom in wake of excesses either of weight or buoyancy, the shipbuilder employs a very simple and well-known device. The concentrated load or support is virtually distributed over a considerable length by means of strong longitudinal keelsons, bearers, etc. In not a few cases these longitudinal pieces are additions to the main framing or structure of the ship; in other cases they form part of the main structure, being effective against the principal strains as well as against local strains. The latter plan is preferable, where it can be adopted, favouring, as it does, lightness and simplicity of construction. These longitudinal bearers and strengthenings can only distribute loads or pressures when they are individually possessed of considerable strength; and to be efficient they must be associated with structural arrangements which provide ample transverse strength (such as complete or partial bulkheads, strong frames, etc.), and form points of support to the longitudinals. Frequently the longitudinals must be continued

through a length sufficient to connect and secure the mutual action of parts where there is an excess of weight with others where there is an excess of buoyancy. But in very many ships, and especially in iron or steel ships, there are cross-sections, like those at bulkheads, where alteration of the form is scarcely possible. In such cases the bearers distributing a concentrated load or pressure frequently extend from one of the strong cross-sections to the next: just as the girders of a bridge extend from pier to pier, and, if they are made sufficiently strong, can transmit a concentrated load placed midway between the piers to those supports without any sensible change of form.

The *Great Eastern* furnished a good example of the last-mentioned arrangement. In the lower half of her structure there was very little transverse framing. Numerous and strong transverse bulkheads supplied the strength requisite to maintain the transverse form unchanged. Strong girders, or frames, extended longitudinally from bulkhead to bulkhead, and transmitted the strength of the bulkheads to the parts lying between them. Arrangements of a similar, but not identical, character are also made in the ironclad ships of the Royal Navy, and in merchant ships built on the cellular system. The engine and boiler bearers in many iron and steel steamers are also arranged on this principle.

Vessels with few transverse bulkheads, or with none, have strong keelsons, binding strakes, stringers, and other longitudinal strengthenings on the flat of the bottom below the bilges, these pieces distributing loads and adding to the structural strength. This is the common arrangement in wooden ships of all classes; but in the latest wood-built ships of the Royal Navy and the French Navy iron bulkheads were constructed, and, in some cases, iron bearers and keelsons were fitted. Wood-built American river steamers furnish curious illustrations of the connection of parts of a ship having surplus buoyancy with others having surplus weight. Besides strong longitudinal keelsons, the builders have recourse to the "mast-and-guy" system. Poles or masts are erected at parts of the structure having surplus buoyancy; these masts are stepped upon strong timber keelsons. Chain or rod-iron guys are then secured to the heads of the masts and connected at their lower ends to parts of the vessel where considerable weights are concentrated, thus hanging these parts on, as it were, to the buoyant parts. In this fashion, the long fine bows and sterns are prevented from dropping; and, in wake of the machinery, tendencies to alter transverse form are similarly resisted. Such arrangements are, of course, only applicable to vessels employed in smooth water, not subjected to the changes of strain to which sea-going ships are liable. The guy-rods can transmit

tension, but not thrust; and the plan answered admirably in these long fine vessels, having great engine-power and high speed.

Iron or steel ships have comparatively thin shell-plating stiffened by transverse and longitudinal frames. Between these frames there are necessarily portions of the plating which are unsupported, and have to resist the pressure of the water when ships are afloat. This pressure tends to force the plating inwards between the frames; and in deep-draught ships, with widely spaced frames and flat surfaces of plating, the resulting strains on the material may be considerable, in relation to the strains due to longitudinal bending. When the plating has considerable curvature, it can oppose much greater resistance to deformation between the frames than when it is flat. The "lapped" edges of the plating also give additional stiffness to the bottom; and this fact is an argument in favour of using moderate widths of thin plating. In practice, the necessities of the case are readily met by adopting such a spacing and disposition of the stiffening frames, in association with the selected thickness of plating, as will prevent deformation of the bottom.*

Grounding is another cause of more or less severe local strains, the intensity depending upon the amount and distribution of the supports. Very concentrated supports, as has already been shown, may crush up the bottom; distributed support such as a ship obtains when docked or fairly beached produces strains which can be easily met. Every provision described above for giving stiffness to the bottom of a ship is also efficient in helping her when aground. In fact, to these provisions shipbuilders mainly trust, making few special arrangements against local strains due to grounding, and these almost wholly at the extremities. Nor is this surprising, for it is impossible to foresee all the conditions of strain, or to provide against them, and such accidents to any individual ship are comparatively rare.

Penetration of the skin of a ship ashore often takes place without any serious crushing up of the bottom; and this danger is of peculiar importance to iron and steel ships, having skin plating rarely exceeding an inch in thickness, and in the great majority of cases less than half that thickness. Sharp hard substances, such as rocks, will penetrate the plating more readily than they will penetrate the much thicker bottom of a wood ship. This superiority of wood ships in sustaining rough usage ashore without penetration of the bottom is well known; formerly some persons attached such importance thereto as to advocate the construction of ships with wooden floors

* For an interesting discussion of this feature of construction, see a paper by Mr. Yates in the *Transactions* of the Institution of Naval Architects for 1891.

and bottom planking, but otherwise of iron. The plan had obvious disadvantages, and did not find favour with shipbuilders.

It is sometimes assumed that iron and steel bottoms are more inferior to wood in their resistance to penetration than is really the case. The late Sir W. Fairbairn made a few comparative tests of the resistances of wood planks and iron plates to the punching action of a very concentrated support.* Under the experimental conditions an oak plank 3 inches thick was found equal in resistance to an iron plate $\frac{1}{4}$ inch thick; and a 6-inch plank to a plate 1 inch thick. Planking appeared to offer a resistance proportional to the *square* of the thickness; whereas iron plating offered a resistance proportional to the thickness only. The largest iron ships have, therefore, bottom plating about equivalent to a 5-inch or 6-inch oak plank. This would be quite as thick as, or thicker than, the average bottom planking of large wood ships; but within this planking the wood ship often had solid timbers and fillings, forming a compact mass, very difficult of penetration, the iron ship having no similar backing to the thin plating. It is therefore easy to see why wooden ships were, as a rule, capable of standing more of the wear and tear incidental to grounding than ordinary iron ships with a single bottom.

Experience has proved that mild steel plating, on account of its greater ductility, is much more capable of resisting the strains produced by grounding than iron plating. Under conditions which would cause the latter to be fractured, mild steel often bulges and stretches without fracture.

It would obviously be wasteful and unwise to increase the thickness of the plating in iron or steel ships in order to increase the resistance to penetration under exceptional circumstances; the preferable course is to fit an inner skin, and to form a cellular double bottom of the character described at p. 34. Then, if the outer bottom is broken through, there is a probability that the inner skin will remain intact, and that no water will enter the hold. In the manoeuvres of 1892, H.M.S. *Apollo*, when moving at considerable speed, struck the Skelligs rocks off the coast of Ireland, and very seriously damaged a considerable length of the outer bottom on both sides below the bilges. The inner skin held good, however, and the ship proceeded under her own steam to Queenstown, and subsequently to Chatham, without repairs to the damaged bottom. No wood ship would have been likely to have retained the power of independent navigation after such an accident, even if she had survived it.

* See the account of the experiments given in Sir W. Fairbairn's work on "Iron Shipbuilding."

The local strains on the decks of ships constitute another important group. Very heavy weights are placed upon certain parts of the decks, resting only upon a certain number of the deck-beams; and no little care is needed in connecting the beams with the sides of the ship, arranging the pillars beneath them, or taking other means to distribute the load. If the loads to be carried were known, and the kind of pillaring determined, it would be a comparatively easy matter to fix the dimensions of the beams required to support the loads. In practice, however, these conditions are not commonly fulfilled. In proportioning the sizes of the beams regard is had to successful experience in past practice, and to any special circumstances in individual cases. The breadth amidships is obviously an important element which must be considered. In war-ships, the loads to be carried are often excessively great, and their positions can be fixed; as, for example, the turrets of a vessel like the *Devastation*, or the guns in the battery of a broadside ship. Beams of exceptional strength, or beams spaced more closely than at other places, are often employed in such cases; but even then it is not sufficient to regard the beams as girders supporting certain loads, with the assistance of the pillars. Both beams and pillars, besides meeting these local strains, have to assist in the maintenance of the transverse form of the ship. Sometimes it happens, especially in wake of the machinery or boilers, that it is difficult to fit pillars under some of the beams; but these beams are easily supported by longitudinal girders extending a sufficient distance fore and aft to have their ends upheld by very strong pillars.

Another class of local strains, of special importance in a war-ship, are those brought upon the bows by collision with another vessel. The great majority of the armoured and protected ships of all navies have been constructed with bows specially designed for delivering an effective blow upon an enemy without receiving serious damage themselves. Spur-bows, protruding forward under water in such a fashion as to be able to strike the comparatively weak bottom below the armour of the ironclad attacked, are those which find most favour. Whatever may be the form of bow adopted, it must be made exceptionally strong if it is to successfully withstand the shocks and strains produced by ramming. These strains may be arranged in three divisions: (1) direct strains, tending to drive the stem and bow bodily backwards into the ship; (2) twisting strains tending to wrench the bow off when the bow is struck obliquely, or the vessel attacked has motion across the bow of the ram-ship; (3) strains tending to perforate the skin of the ram-bow, resulting from the jagged parts of the hull of the vessel which has been struck pressing upon the ram, while the two vessels are locked together, and

while the wrenching just mentioned takes place. Similar strains act upon the bow of any ship which comes into collision with another; and unfortunately there are too numerous instances of the truth of this statement in the records of accidental collisions between vessels of the mercantile marine, or other ships not built for ramming. In fact, it is to these ordinary vessels, and not to ships specially designed for ramming, that one must look for the fullest evidences of the character of the strains incidental to collision. The bows of many ships have actually been crushed in; or the skin has been penetrated; or wrenching strains—as in the ill-fated *Amazon*, of the Royal Navy—have been so serious in proportion to the strength of the bow as to twist the latter and cause the ship to founder. On the other hand, we have ample evidence that the special arrangements of ram-bows provide satisfactorily against strains which are fatal to weaker bows.

At Lissa, the Austrian ram *Ferdinand Max*, a wood ship with a strengthened ram-bow, struck and sank the *Re d'Italia*, besides making less successful attacks on other Italian ships; yet her bow sustained no serious damage, although it suffered more than an iron-built ram would have done under similar circumstances. The improvised Confederate ram *Merrimac* sank the Federal wooden frigate *Cumberland* at Hampton Roads, but wrenched her own spur badly in consequence of its faulty construction, and is said to have been consequently far less efficient in her subsequent fight with the *Monitor*. The disastrous collision between the *Vanguard* and the *Iron Duke* furnished a very severe test of the strength of the ram-bow in modern types of iron-hulled ironclads. To understand the severity of the test, it is necessary to note a few facts given in evidence before the court-martial. At the time of the collision the *Iron Duke* is said to have been going $7\frac{1}{2}$ knots, her course being 6 points off that of the *Vanguard*; the direct force of the blow delivered was at least 12,000 foot-tons. Fig. 30, p. 36, illustrates the damage done to the *Vanguard*, the armour being driven in bodily and the outer bottom pierced by a huge hole some 20 or 30 square feet in area. Such a blow, of course, reacted on the bow of the *Iron Duke*, tending to drive it back into the ship; and meanwhile the *Vanguard* had a speed athwart the bow of the *Iron Duke* of no less than 6 knots, the motion producing a tendency to twist and wrench the bow, as well as to perforate the skin. The simple and comparatively light arrangements of the ram-bow answered admirably when thus severely tested, subsequent examination proving it to be so little damaged that the *Iron Duke* could, in action, have ventured safely on a repetition of the blow, and yet have remained efficient. Much greater damage was done to the

ram-bow of the German ironclad *König Wilhelm* when she came into collision with the *Grosser Kurfürst*. A portion of the heavy iron stem of the former was nearly wrenched out of place, and the armour and bow-plating, etc., abutting on the stem were considerably disturbed. Although in some respects the structure of the bow of the German ship was inferior to that of the *Iron Duke*, the differences

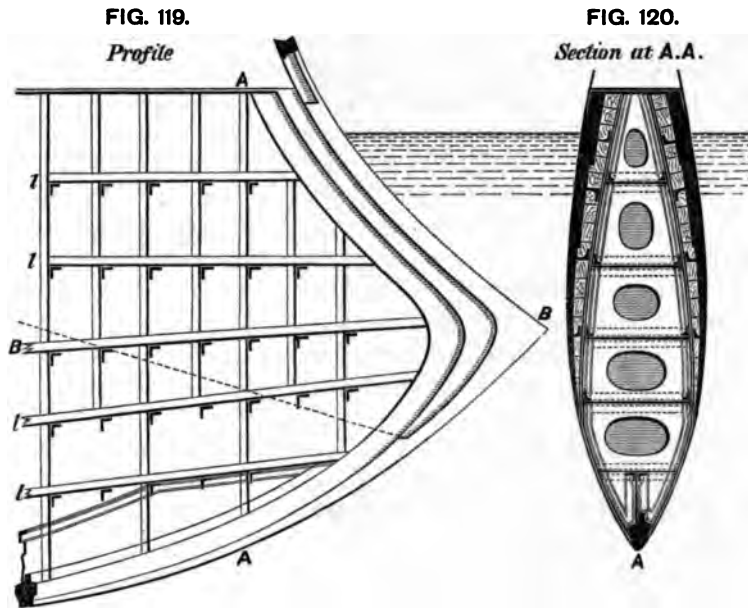

in the injuries received are probably chiefly due to the fact that at the time of collision the *Grosser Kurfürst* was crossing the bows of the *König Wilhelm* at a high rate of speed.

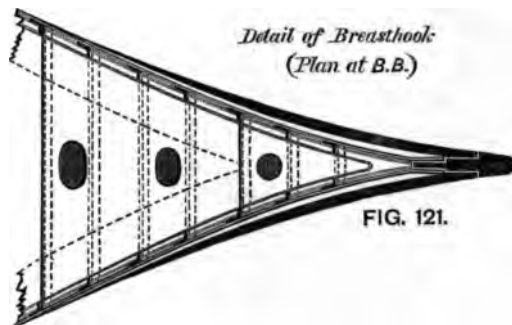

Figs. 119-121 have been drawn to illustrate the principal features in the framing of a ram-bow in a ship having a water-line belt of armour extending to the bow; and only a few explanatory remarks will be required. The stem is a solid forging or casting, weighing

several tons. Against direct strains tending to force it backward, it is supported by the longitudinal frames or breasthooks (*l, l*, in Fig. 119), as well as by the armour-plating, backing, and skin-plating, all of which abut against the stem. The breasthooks are very valuable supports, being very strong yet light; their construction is shown in Fig. 121; and the foremost ends of the decks are converted into breasthooks in a somewhat similar manner. Wrenching or twisting strains are well met by these breasthooks, stiffened as they are by numerous vertical frames, the details of which appear in Fig. 120, while their positions are indicated in Fig. 119. Perforation of the skin is rendered difficult either by carrying the armour low down over the bow as indicated by the dotted line in Fig. 119 or by doubling the skin-plating forward below the armour. Although the transverse framing of the ram-bow is quite subordinated to the longitudinals (*l, l*), it plays an important part in binding the two sides together, stiffening the breasthooks, and enabling a minute system of watertight subdivision to be carried out. Even if the skin should be broken through in ramming, water would find access to a very limited space, and consequently there would be little or no danger, and no inconvenient change of trim.

Ships in which the armour-belt is not carried to the bow are somewhat differently constructed for ramming. The armoured deck, situated several feet under water, is the strongest part of the structure which contributes the greatest support to the spur-bow. These decks are usually curved downwards at the fore end, for the purpose of gaining such a depth below water as will enable the spur to pierce an enemy below the armour. The spur is attached to the fore end of the deck, by which it is supported most efficiently against direct and wrenching strains. Subsidiary supports, breasthooks, etc., are also employed to a small extent; and in some cases arrangements have been made by which, if the spur should become locked in the side of the vessel attacked, it might actually be wrenched off without any serious damage to the bow. Perforation of the skin below the armour deck is provided against to some extent by doubling the plating. Thick side plates are also fitted above the armour deck, and rabbetted into the stem.

Ram-bows in wood ships may be made fairly efficient, but not so simply or satisfactorily as those of iron or steel ships, the difference being one inherent in the materials. To make the spur more efficient, it is usually armed with a sheath of metal or iron. Massive longitudinal and diagonal timbers are bolted inside the frames, and associated with iron crutches or breasthooks, to prevent the stem from being driven in or twisted when a ram attack is made. But even when all possible care is taken in fitting and fastening these

strengthenings, the combination can scarcely be considered satisfactory. Weakness, working, and decay must affect it, as they do all other parts of a wooden structure.

The superior strength of the bows of iron ships has been illustrated frequently in the mercantile marine, as well as in war-ships. Commonly, when collisions take place between two iron ships, the vessel struck is seriously damaged, perhaps founders, while the striking vessel escapes with little damage to her bows. Nearly twenty years ago, when the *Persia*, one of the earliest iron-built Transatlantic steamers, was on her first voyage, she closely followed the *Pacific*, a wood steamer, and both are reported to have fallen in with large ice-floes. The *Pacific* was lost; the *Persia* ran against a small iceberg at full speed and shattered it, but sustained no serious damage. In recent years the *Arizona* had a similar escape after collision with an iceberg.

The last class of local strains to be mentioned are those incidental to propulsion. Some of these have already been alluded to, viz. the strains connected with propulsion by sails, and those resulting from the attachment of the thrust-bearer to the hull of a screw-steamer. To these may be added the strains produced by the moving parts of an engine, through the bearers to which they are secured; vibration or working at the stern of screw-steamers; strains in wake of the shafts of paddle-steamers; and many others. The whole subject is, however, one of detail, requiring to be dealt with during the construction of the vessel by her builder and the maker of the engines. Here again the general principle of *distribution of strain* underlies all the arrangements made. The parts upon which the strains are primarily impressed must be succoured by other parts of the structure, with which they must be connected as rigidly as possible. Change in the relative positions of the various parts cannot occur so long as the connections are efficient, and without such changes working cannot take place. Iron and steel are far better materials than wood for making the connections, and they have been employed very generally for the purpose, even in wood ships, with great success.

As an illustration of the usefulness of iron strengthenings in resisting local strains due to propulsion in wood, Figs. 122-123a have been drawn, representing the arrangements at the stern of one of the latest wood-hulled ironclads of the Royal Navy. Similar strengthenings have been extensively used in unarmoured wood ships. They were introduced in consequence of the serious working and weakness not unfrequently experienced at the sterns of the earlier screw steam-ships with large engine-power; and by their use these objectionable results were altogether prevented. Inside

the ship (see Fig. 122) the upper parts of the two stern-posts were cased with iron plates; the heads of the posts were secured to iron plating (*cc*) worked on the upper beams. Between the two posts an iron knee (*bb*) was fitted, and strongly secured to the posts and

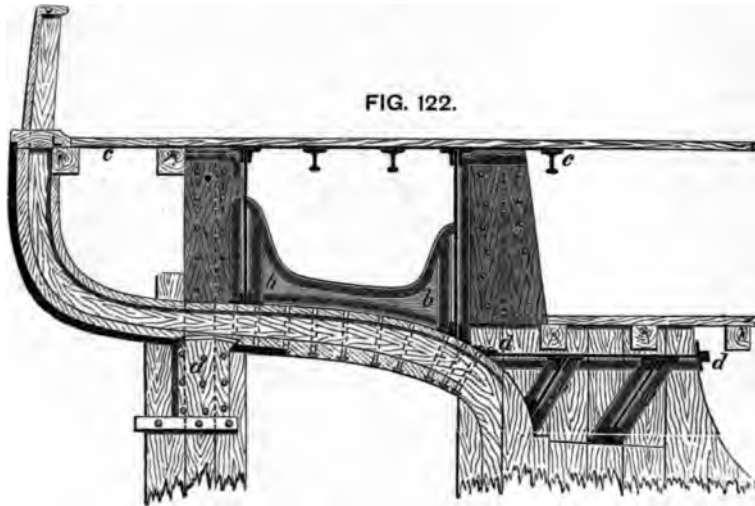

to the counter of the ship. With a lifting screw, this knee could not be fitted, but the screw-well was then made an efficient strengthener. Partial bulkheads of iron were built across the stern at the fore side of the rudder-post and the aft side of the body-post.

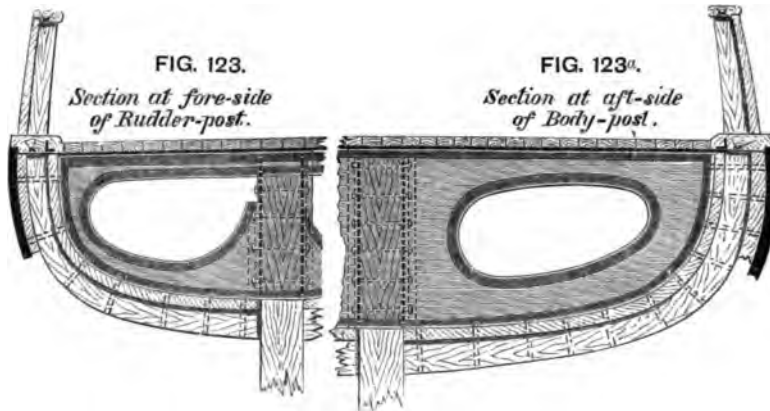

The construction of these is shown in Figs. 123 and 123a; their upper edges were secured to the deck-plating (*cc*), while their outer edges were bolted to the sides of the ship. Change of form was thus rendered practically impossible at those two sections. Change in the angle between the counter and the rudder-post was rendered

difficult by the external metal knee *a*, Fig. 122, bolted to the post and the counter. Formerly these counter-knees constituted the main strengthening at the sterns of wood ships, and they were very frequently broken in the "throat" by the working of the post produced by the action of the propeller. The body-post was also strongly connected to the hull by the iron plating (*dd*, Fig. 122) under the lower-deck beams, and the brackets (*ee*). By these comparatively light and simple additions, what had been previously found an almost insoluble problem was satisfactorily dealt with.

The local strains incidental to propulsion by sails require to be carefully guarded against. Masts must have considerable strength in themselves to resist both the bending strains tending to break them off near the upper wedging-deck and the compressive strains due to the thrust produced by the tension of the shrouds. Strong shrouds, stays, or other supports must be associated with the masts; these should have as good a "spread" as possible (*i.e.* make as large an angle as possible with the masts); and all such supports must be well secured to the hull proper by chain-plates, channels, etc. Neglect of proper precautions, in making extensions of practice beyond the limits of precedent, have led to accidents, and to the dismasting of many sailing ships. During the period 1874-77 accidents of this kind were so numerous amongst iron merchant ships of large size and great sail-spread, fitted with iron masts, that the Committee of Lloyd's Register of Shipping gave special attention to the matter. Their professional officers drew up a report which contained a most able and exhaustive discussion of the strains to which masts and rigging are subjected, and of their strength to resist those strains. When scientific analysis has been carried to its limits in this matter, recourse must be had to the particulars of the masts and rigging of ships which have borne successfully the strain and stress of service when deciding on the corresponding features in other ships. This method of procedure has long been followed in the Royal Navy, where the *data* as to masting, etc., obtained and tabulated long ago for the now obsolete classes of sailing ships, have furnished rules for practice up to the present time, and have made serious accidents, such as dismasting, almost unknown. Considerable changes have had to be made in consequence of alterations in the structures or types of ships; but where special causes have intervened, special precautions have been taken. For example, in the *Monarch*, where it was desirable to remove all possible obstructions to the fire of the turret guns, the masts were made of exceptional size and strength, in order that they might be capable of standing with fewer shrouds than usual when the ship was cleared for action. In other ships

where the spread of the rigging has been less than usual, the shrouds have been made exceptionally strong. Rigid tripod supports to the masts have also been used in a few rigid turret-ships, in order to secure an increased horizontal range of fire for the guns. All these variations in practice have been successfully carried out, by means of a careful and intelligent adaptation of the experience gained in preceding ships.

CHAPTER IX.

THE STRUCTURAL ARRANGEMENTS AND STRENGTH OF SHIPS.

THE structural arrangements now adopted in various classes of ships are the results of long-continued development. Their origin is lost in antiquity, and many of the succeeding steps cannot be traced. During long periods, under the same conditions, methods of construction have remained unchanged; but altered circumstances and fresh requirements have produced great and rapid changes. From the canoe hollowed out of a single tree, or the coracle with its light frame and flexible water-tight skin, on to the enormous floating structures of the present time is a very remarkable advance; but the steps have been gradual, and not unfrequently unintentional. In many instances the full value of a new feature has not been recognized until long after its introduction. The history of this gradual change and improvement, culminating in the wonderful progress of the last half-century—into which have been crowded the development of ocean steam navigation, the introduction of iron and steel seagoing ships, and the use of armoured war-ships—constitutes a most interesting field of study; but in the present work it cannot be touched. Nor can the structural arrangements of existing types of ships receive detailed illustration, for which the reader must turn to strictly technical treatises on shipbuilding. It will be our endeavour—bearing in mind what has been already said respecting the causes and character of the principal straining forces to which ships are subjected—to make clear the general principles governing the provision of their structural strength. In doing so, it will be possible to illustrate the distinctive features in the principal classes of ships, to compare the relative efficiencies of various methods of construction, and to contrast the degrees of importance attaching to different parts of the hull. All that will be assumed is that the reader has a general acquaintance with the names of the different parts; and in most cases even that extent of knowledge will scarcely be requisite in order to follow the discussion.

All ships may be said to consist of two principal parts: (1) the water-tight skin forming the covering of their bottoms, sides, and decks, if they have decks; (2) the framing or stiffening fitted within the skin to enable it to maintain its form. There are many ways of forming the skin in different classes of ships; some of these will be described. A skin is an essential part of every ship; and much care and skill are required in its arrangements. Vessels have been built with little or no framing; but these are not ordinary cases, and probably the greatest varieties of practice are to be found in the arrangement of the framing, which constitutes a very important element of the structural strength. In constructing both skin and framing, and considering every detail of the hull, the shipbuilder should seek most fully to combine strength with lightness. To do this, he must possess an intelligent acquaintance with the causes and character of the strains to be resisted, their possible effects upon different parts of the structure, and the principles of structural strength. He is then able to choose from among the materials obtainable those best adapted for his purpose. He can duly proportion the strength of the material to the strains on the various parts, massing it where requisite, or lightly constructing parts subject to little strain. So far as the requirements of convenience and accommodation, or of fighting efficiency, permit, he can approximate to an ideally perfect structure, in which each part is equally strong as compared with the strain it has to bear. No structure is stronger than its weakest part; consequently a bad distribution of the materials can only be made at the sacrifice of strength, which might be secured with the same or possibly with less weight if the material were distributed more in proportion to the straining forces.

Another important practical matter is that of the connections and fastenings of the very numerous pieces making up the hull of a ship. Unless great care is taken, the ultimate strength of these pieces will never be developed, and the structure may fail through lack of rigidity, even when it contains an amount of materials which would be ample if they were properly combined. The character of these connections must bear an intimate relation to the qualities of the materials. With wood they are necessarily different from what they would be with iron or steel. In fact, the builder has to consider this feature in making the choice of the material. Regard must be had not merely to the ultimate resistance of a *single piece* to tensile or compressive strains, but also to the possibility of making a *combination* of two or more pieces efficient against such strains. Having made his choice, he has to effect the best possible connections and combinations, often at no small

cost, in order to secure the joint action of the various pieces, and the rigidity of the structure considered as a whole.

In the present chapter it will be convenient to assume that the best possible results have been secured by the builder in each class of ship, and then to investigate their resistances to the *principal* bending strains, tending to alter the longitudinal and transverse form. Local strains have received in the preceding chapter all the attention that can be given them. In the succeeding chapter we shall illustrate the capabilities of wood, iron, and steel as materials for shipbuilding.

The severest strains to which ships are subjected are those tending to produce longitudinal bending; and therefore the greatest strength is requisite to prevent change of form in that direction. If the ship were subjected to excessive bending moments, developing strains greater than her strength could resist, their ultimate effect would be to break her across at the transverse section where the strains reach their maximum; and this section would usually be situated near the middle of the length. Cases are on record where this ultimate effect has been produced, and vessels, when very severely strained, have actually broken across.* Ordinarily, instead of actual fracture, we have only to consider a tendency to produce fracture at any cross-section of the ship, the structural strength being ample in proportion to the strains.

Resistance to longitudinal bending or cross breaking at any transverse section of a ship can only be contributed by those pieces in the structure which *cross* the probable line of fracture, *i.e.* the particular transverse vertical section of the ship which is being considered. Pieces lying longitudinally or diagonally in the ship may fulfil this condition, and therefore contribute to the longitudinal strength; pieces lying transversely, such as transverse ribs, frames, or beams adjacent to the line of fracture, do not cross it, and therefore do not contribute to the longitudinal strength. It is, therefore, easy to distinguish those parts of the hull which are efficient against the longitudinal bending moments. Chief among these may be mentioned the skin planking or plating on the outside of the ship; the planking or plating on the decks; and the longitudinal frames,

* One of the most singular cases on record is that of the *Chusan* iron steamer, which broke in two outside Ardrossan, one part of the vessel floating into the harbour, while the other sunk outside. This ship was not built for seagoing service, being designed for the shallow waters of China. Her length was 300

feet, beam 50 feet, and depth in hold only 11 feet. Another case in point is that of the *Mary*, which broke in two in the Bay of Biscay; she was a shallow-draught vessel of great length, in relation to her depth. A third case is that of an American lake steamer which was lost in 1892.

keelsons, shelf-pieces under beams, water-ways, side-stringers, and diagonal iron riders. For any transverse section of the ship, the enumeration of all these parts and the estimate of their respective sectional areas are simple processes, upon which the calculation of the strength of the ship at that section is based.

The greatest bending strains being experienced usually at or near the midship section, let it be assumed for purposes of illustration that the ship is upright, and that it is desired to ascertain the strength of the midship section against cross-breaking strains. In performing this calculation, it is usual to construct an "equivalent girder" section, similar to that shown in Fig. 124. On the left is drawn an outline of the midship section of an iron or steel ship with a double bottom, and with longitudinal frames between the outer and inner skins, these latter being indicated by the strong black

FIG. 124.

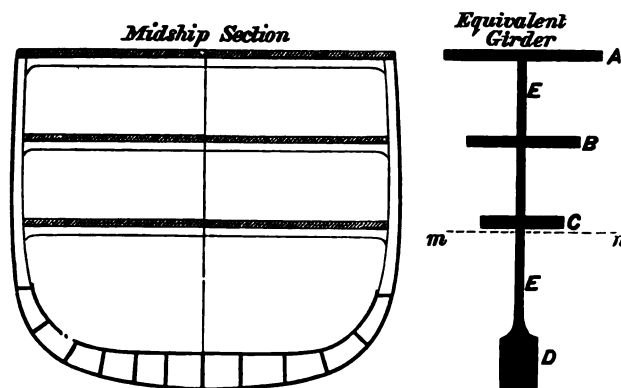

lines. On the decks, the planking, plating, and stringers will also be distinguished from the transverse beams upon which they are supported. The *effective areas* of all these pieces which cross the midship section, and extend to some distance before and abaft it, are represented in the "equivalent girder" on the right. The deck planking and plating on the upper deck are concentrated in the flange A; those of the middle deck in the flange B, and those of the lower deck in the flange C. The inner and outer bottom plating, longitudinal frames, etc., from the turn of the bilge downwards are concentrated in the lowest flange or bulb D; the vertical or nearly vertical plating on the sides, together with the longitudinal stiffeners worked upon it, form the vertical web EE, connecting the flanges. It will be observed that the depths of the girder and midship section are identical, and all the corresponding pieces in both are situated at the same heights, the vertical distribution

of the pieces on the midship section being maintained in the girder.

There are many points of interest connected with the work of constructing equivalent girders. Only some of the most important need be mentioned. First, it is necessary to distinguish between the *total* sectional areas of the longitudinal pieces on the midship section, and their *effective* areas which are shown on the girder. A very simple illustration will show the character of this distinction. In wood ships it is usual to arrange the "butts" of the outside planking so that at least three planks intervene between consecutive butts lying on the same transverse section. Fig. 125 shows this arrangement; b and l are two butts placed on the same timber; and the probable line of fracture of the planking between these butts is indicated. Against tensile strains tending to pull the butts open on any section such as bl , the butted strakes have no strength; therefore, in order to allow for this weakening of the midship section, *one-fourth* of the total sectional area of the outer planking must be deducted. Further, there must be bolts or wooden treenails driven

FIG. 125.

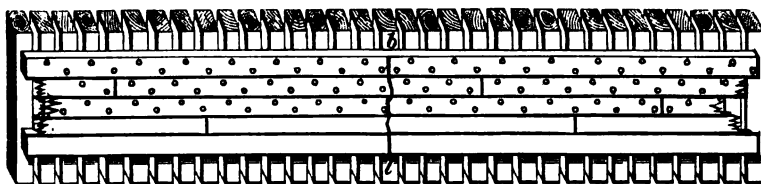

in the unbutted planks, to secure them to the ribs of the ship; and the holes cut for these fastenings at any cross-section may be taken as equivalent to a further loss of about *one-eighth* of the total sectional area. Putting together the allowances for butts and fastenings, it appears therefore that the *effective* sectional area of planking thus arranged is about *five-eighths* of the total sectional area when resistance to *tensile* strains is being considered. When *compressive* strains have to be resisted, the conditions are different. If the butts are properly fitted and caulked, the butted strakes are nearly, if not quite, as efficient as the unbutted strakes; and if the bolts and treenails properly fit their holes, no deduction need be made for these holes. Hence, against compressive strains, the effective area practically equals the total sectional area. Similarly, in iron ships, the holes for the rivets securing the outer plating to the ribs cut away about one-seventh or one-eighth of the total sectional area, and this deduction must be made from the total area in order to find the area effective against tensile strains; whereas against compressive strains no such deduction is needed. In many other instances

similar allowances are required, and can be readily made when the details of the construction of a ship are known.

Some shipbuilders prefer to dispense with this determination of effective sectional areas, and use total sectional areas in constructing the equivalent girder; which is therefore the same both for hogging and for sagging strains. This procedure is not so accurate as that described above, and the resulting economy in labour is not great. It has been chiefly employed in calculations for merchant ships where the severest strains experienced are usually hogging strains bringing the decks and upper works into tension. So long as the departure from accuracy is borne in mind the process is unobjectionable. But in computing the stresses corresponding to a given bending moment, the employment of the total instead of the effective sectional areas, obviously leads to results which fall below the truth.

Another important matter is the determination of the relative values of wood and iron, or wood and steel, when they act together in resisting longitudinal bending. So long as the stresses put upon the materials do not surpass the "limits of elasticity" of the wood, it is a fact, ascertained by experiment, that the wood will act with the metals and lend them valuable assistance. This is very advantageous to the structural strength of ships of all classes, in which plates (stringers or ties) are used on the decks and elsewhere, with wood planking over them. In composite ships also, with a wood skin worked on iron or steel ribs, and in sheathed ships, wherein wood planks are worked outside the skin plating in order to receive zinc or copper sheathing, this combined action of wood and metals is of great value. The late Professor Rankine suggested some years ago that a fair allowance, averaging the various strengths of the timbers used in shipbuilding, would be to consider wood equivalent to *one-sixteenth* of its sectional area of iron; and this is the allowance usually made in determining the effective sectional areas for the portions of the deck-flanges (A, B, C, in Fig. 124), representing the wood planking, or for other parts where plating and wood act together.

When the equivalent girder has been drawn, the next step is to estimate the strength of the midship section thereby represented. This is done exactly in the same manner as if the girder were the cross-section of a long beam, subjected to the same bending strains as those to which the ship is subject. The comparison of a ship tending to hog or sag to a beam is a very old one, having been made by some of the earliest writers on the theory of naval architecture. Like many other suggestions, this was not made use of to any great extent until the introduction of iron shipbuilding. The

late Sir William Fairbairn did much towards establishing the practice of treating a ship as a hollow girder, so far as longitudinal bending is concerned. Readers familiar with mathematical investigations of the strength of beams will not require any further explanation respecting the use made of the equivalent girder; but, in order to assist those not acquainted with these investigations, a brief explanation will be given of the principal steps by which the strength of a beam may be calculated.

Fig. 126 shows the side view and section of a flanged beam, which is bent by the action of the downward pressures P, P , and the upward pressure Q . When it is thus bent, the convex upper side AB must have become elongated, as compared with its length when the beam was straight; whereas the concave under side CD must have been shortened. Hence at some intermediate part—suppose at EF —there will be found a surface which is neither stretched nor compressed, but maintains the same length which it had when the beam was straight. The surface EF is termed the “neutral surface”; all parts of the beam lying above it are subject to tensile strain,

FIG. 126.

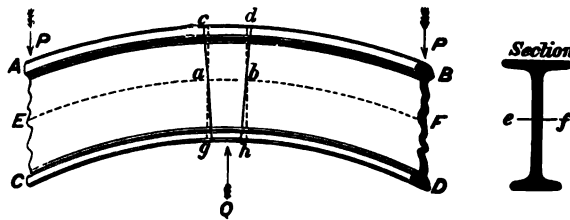

all parts below are subject to compressive strain. In the sectional drawing of the beam, ef corresponds to EF , and is termed the *neutral axis* of the cross-section. On the neutral surface EF , let any two points ab be taken. When the beam is bent, the corresponding length on the upper surface is shown by cd , and that on the lower surface by gh ; the figure $cghd$ therefore represents the shape into which the bending of the beam distorts that part which was of the uniform breadth ab throughout the depth of the beam, before it was bent. For any layer in the beam the elongation or compression produced by the bending varies directly as the distance of that layer from the neutral surface. Within the limits of elasticity of the material the elongation or compression also varies directly as the strain applied; that is to say, a bar of the material will stretch *twice* as much with a given weight suspended to it as it does with half that weight suspended; and so on. Hence it will be seen that in a bent beam the stress on each unit of sectional area in a cross-section such as that in Fig. 126, or any other form of

section, varies directly with the distance of that unit from the neutral axis *ef*. At the upper surface AB the stress will be twice as severe as it is midway between AB and EF, and the tensile strain at AB bears to the compressive strain at CD the same ratio as the distance of AB from EF bears to the distance of CD from that surface.

The question thus arises, What governs the position of the neutral axis? The answer is very simple. It is coincident with the *centre of gravity* of the cross-section of the beam, supposing (as may fairly be done) that the external forces P, P, Q act perpendicularly to the surface EF. This follows directly from the consideration that the sum of all the tensile forces developed on any cross-section of the beam must equal the sum of the compressive forces. The neutral surface of the beam contains the centres of gravity of all the cross-sections; and this condition holds for all forms of cross-section, and all variations in form at different parts of the length; the preceding remarks containing no assumption that the beam is of uniform cross-section throughout its length. When the form of the cross-section of any beam is given, the above stated property enables the position of the neutral axis to be determined.

One further step remains to be explained. At any cross-section of the beam in Fig. 126 (say, at the middle of the length) the external forces (P and Q) give rise to a bending moment the value of which is easily ascertained. The effect of this moment is seen in the curvature of the beam; but it may be asked by what moment is the moment of the external forces balanced. Obviously it must be balanced by the moment of the internal forces* (*stresses*, as they have been termed) developed by the elongations and compressions. Each of these stresses may be considered as a force acting perpendicularly to the plane of the cross-section, and having for its fulcrum the neutral axis; and in this resistance to the external forces the internal forces all co-operate, from top to bottom of the beam. The total moment of these internal forces, about the neutral axis for any cross-section, is easily determined. It has been remarked that the stress on each unit of sectional area varies directly as its distance from the neutral axis. Let it be assumed, therefore, that under the

* In mathematical investigations it is usual to use the term "stress" as defined above, and to restrict the term "strain" to deformations produced by the action of any force or forces. Ship-builders and naval officers use the latter term more freely; in the sense both of the internal forces (or stresses) developed, and the deformation or tendency to

deformation resulting from the action of external forces. This course has been frequently followed in the text for the greater convenience of professional readers, and no confusion need result, as the sense in which the terms "strain" and "straining force" are used will always be apparent from the context.

action of certain external forces, a stress of s lbs. is experienced by a *square inch* of sectional area at *one inch* distance from the neutral axis. Then the corresponding stress on a square inch of sectional area at a distance y inches from the neutral axis will be expressed by the equation—

$$\text{Stress} = s \cdot y \text{ lbs.}$$

The moment of this stress about the neutral axis equals the product of its amount by the distance y . That is—

$$\text{Moment of stress} = s \cdot y^2 \text{ (inch-pounds).}$$

This last expression holds good for each square inch of sectional area. Hence for any cross-section of the beam—

$$\begin{aligned} \text{Moment of resistance} &= \text{sum of moments of the stresses on each unit} \\ &\quad \text{of sectional area} \\ &= \Sigma(sy^2 \cdot \delta A) \\ &= s \cdot \Sigma(y^2 \cdot \delta A) = s \cdot I \end{aligned}$$

where δA is an element of the sectional area at a distance y from the neutral axis; and Σ is the sign of summation for all such elements making up the total cross-sectional area A . The sum of all these products ($y^2 \cdot \delta A$) is termed the “moment of inertia” (say I) of the cross-section, about the neutral axis; and hence it follows that the moment of resistance may be succinctly expressed as the product of the stress on a unit of sectional area at a unit of distance from the neutral axis into the moment of inertia. This moment of inertia depends upon the size and form of the cross-section; the stress (s) at distance unity from the neutral axis depends, for a given cross-section, upon the magnitude of the moment of the external forces producing bending in the beam. Finally it should be noted that the foregoing equations hold good only when the maximum stress experienced by the material in the cross-section does not exceed the “elastic limit.”

The upper and lower surfaces of any cross-section of the beam are those which are subjected to the greatest stresses, being most distant from the neutral axis. If h_1 and h_2 are the respective distances of these surfaces from the neutral axis, and p_1 and p_2 the corresponding stresses per unit of area (say per square inch); then from the foregoing expressions we have for any cross-section—

$$s = \frac{p_1}{h_1} = \frac{p_2}{h_2} = \frac{\text{moment of resistance}}{\text{moment of inertia (I)}}$$

But this moment of resistance to bending must balance the bending moment produced by the external forces, such as P and Q in Fig. 126. Hence finally if M = bending moment of the external forces, about any cross-section of a beam—

$$s = \frac{p_1}{h_1} = \frac{p_2}{h_2} = \frac{M}{I}$$

are equations determining the maximum stresses p_1 and p_2 , when the other quantities are known. The moment of inertia I is proportional to the product of the area of the cross-section into the *square* of the depth of the beam; whereas the distances h_1 and h_2 are proportional to the depth. Hence the ratio of the products of the sectional areas by the depths of two beams of the same material and similar cross-section, is a measure of their relative strengths to resist bending moments.

From the foregoing general expressions a few deductions may be made. With a given sectional area, and a certain material, changes in the forms of cross-sections of beams may largely influence the moment of inertia, and therefore influence the resistance to bending. The *flanged* form of beam shown in Fig. 126 is thus seen to have great advantages, as regards the association of strength with lightness; for the material thrown into the flanges is at a considerable distance from the neutral axis, and the moment of inertia is consequently increased. The vertical web must possess sufficient strength to keep the flanges at their proper distance apart and to efficiently connect them. When this has been done, all the rest of the available material should be thrown into flanges, and in lattice girder beams and bridges the principle receives its fullest development.

Reverting to the equivalent girder for a ship (Fig. 124), it is possible to make use of the foregoing general principles in order to compare the relative importance of different parts of the structure, as measured by their resistance to longitudinal bending. The most important parts are the upper flange A and the lower D; the flange C, corresponding to the lower deck, lies so close to the neutral axis (mn) as to be of little assistance. The flange B is of much more service, but cannot compare in importance with A. The web EE, formed by the side plating or planking, is mainly useful, when the vessel is upright, in forming a rigid connection between the flanges and enabling them to act together. On account of their distance from the neutral axis, the parts of EE lying nearest to A and D offer considerable resistance to bending. When the vessel is inclined, the conditions are somewhat changed; she then resembles a hollow girder set angle-wise. The parts contributing most to the longitudinal strength will then be the upper deck, the sheer-strakes and side plating adjacent to that deck, and the bottom in the region of the bilges; but the arrangements which are efficient when the vessel is upright will also contribute greatly to the efficiency when she is heeled over to the most considerable angles likely to be reached in

rolling. There is good reason to believe that a ship which is strong enough to resist longitudinal bending moments when she is upright will be sufficiently strong in every other position. By general consent, therefore, the upright position is assumed in the construction of the equivalent girder, and most care is bestowed to meet the bending strains incidental to that position.

CALCULATION OF MOMENT OF INERTIA OF SECTION WHEN THE SHIP IS UNDER A HOGGING STRAIN.

Total depth of girder, = feet. 37·5
 Neutral axis below top = $h_1 = 19·3$
 Neutral axis above bottom = $h_2 = 18·2$

Parts of structure.	Effective sectional areas = A.	Distance of centre of gravity from neutral axis = h.	Squares of distances = h^2 .	Products $A \times h^2$.	Depths of webs in girder = d.	Squares of depths = d^2 .	Products $\frac{1}{2} \times A \times d^2$.
	sq. in.	feet.			feet.		
Upper deck flange	155·1	19·2	368·6	57,170	—	—	—
Main deck flange	654·1	10·6	112·4	73,521	—	—	—
Lower deck flange	117·2	3·6	13·0	1,524	—	—	—
Wing passage bulkhead (part)	51·0	5·5	30·2	1,540	9·0	81·0	344
Coal bunker bulkhead (part)	14·0	1·4	2·0	28	2·8	7·8	9
Shelf plate	24·7	·85	·7	17	—	—	—
Skin plating	685·1	10·1	102·0	69,880	18·4	338·6	19,331
Bottom plating above neutral axis	19·0	·4	·2	4	·8	·6	1
Coal bunker bulkhead (lower part)	37·8	3·2	10·2	386	6·3	39·7	125
Wing passage bulkhead (lower part)	63·4	4·6	21·2	1,344	9·3	86·5	457
Bottom plating above bilge	401·0	7·5	56·3	22,576	12·7	161·3	5,390
Bottom flange	889·0	15·8	249·6	221,894	5·5	30·2	2,237
				449,884			27,894
				27,894			
				<u>I = moment of inertia = 477,778</u>			
When the ship is on a wave crest—							
M = bending moment at section just outside battery = 28,000 foot-tons.							
Maximum tensile stress on upper part of section } = $\frac{28,000 \times 19·3}{477,778} = 1·13$ tons per square inch.							
Maximum compressive stress on lower part of section } = $\frac{28,000 \times 18·2}{477,778} = 1·07$ tons per square inch.							

Hogging, it will be remembered, is the change of form produced by the ends of a ship dropping relatively to the middle, the keel

becoming arched upwards. The conditions are then similar to those in the beam, Fig. 126; the upper parts of the structure being subjected to tensile strains, the lower to compressive strains, and the

CALCULATION OF MOMENT OF INERTIA OF SECTION WHEN THE SHIP IS UNDER A SAGGING STRAIN.

Total depth of girder = ^{feet.} 37·5
 Neutral axis below top = $h_1 = 15·9$
 Neutral axis above bottom = $h_2 = 21·6$

Parts of structure.	Effective sectional areas = A.	Distance of centre of gravity from neutral axis = h.	Squares of distances = h^2 .	Products A × h^2 .	Depths of webs in girder = d.	Squares of depths = d^2 .	Products $\frac{1}{2} \times A \times d^2$.
	sq. in.	feet.			feet.		
Upper deck flange	202·9	15·8	249·6	50,644	—	—	—
Main deck flange	777·8	7·1	50·4	39,201	—	—	—
Lower deck flange	148·6	·2	·04	6	—	—	—
Skin plating (part)	681·5	7·9	62·4	42,526	15·8	249·6	14,175
Armour and backing	1657·5	3·2	10·2	16,906	6·5	42·3	5,843
Wing passage bulkhead	{ 43·8	3·2	10·2	447	6·5	42·2	154
	{ 65·0	6·6	43·6	2,834	11·9	141·6	767
Coal bunker bulkhead	46·3	5·2	27·0	1,250	9·2	84·6	326
Shelf plate	24·7	2·6	6·8	168	—	—	—
Skin plating (part)	92·4	1·3	1·7	157	2·6	6·8	52
Bottom plating above bilge	360·1	11·0	121·0	43,572	13·6	185·0	5,552
Bottom flange	767·2	19·2	368·6	282,790	5·6	31·4	2,007

480,501
 28,876

I = moment of inertia = 509,377

When the ship is astride the wave hollow—

M = bending moment at section just outside battery = 47,120 foot-tons.

Maximum tensile stress on lower part of section } $\frac{47,120 \times 21·6}{509,377} = 2$ tons per square inch.

Maximum compressive stress on upper part of section } $\frac{47,120 \times 15·9}{509,377} = 1·47$ tons per square inch.

division between the two being marked by a neutral surface. Sagging is the converse case where the middle drops relatively to the ends; the keel becoming arched downwards, the upper parts of the structure being subjected to compressive strains, the lower to tensile strains, the change of strain being marked by a neutral surface, not agreeing in position with that for hogging. It will indeed be evident, from what has already been said respecting the difference between the total and effective sectional areas of parts of the

structure, that, strictly speaking, the equivalent girder for hogging strains must be different from that for sagging strains ; although, as stated above, the two are sometimes treated as identical. While the sectional areas of the upper and lower flanges A and D of the equivalent girder in Fig. 124 change both their absolute and relative values, according as hogging or sagging strains have to be resisted, it is still true, for both hogging and sagging, that these are the two parts of the structure which are of the greatest assistance in resisting change of form. Their joint action is secured by means of the web formed by the vertical or nearly vertical portions of the skin.

FIG. 127.

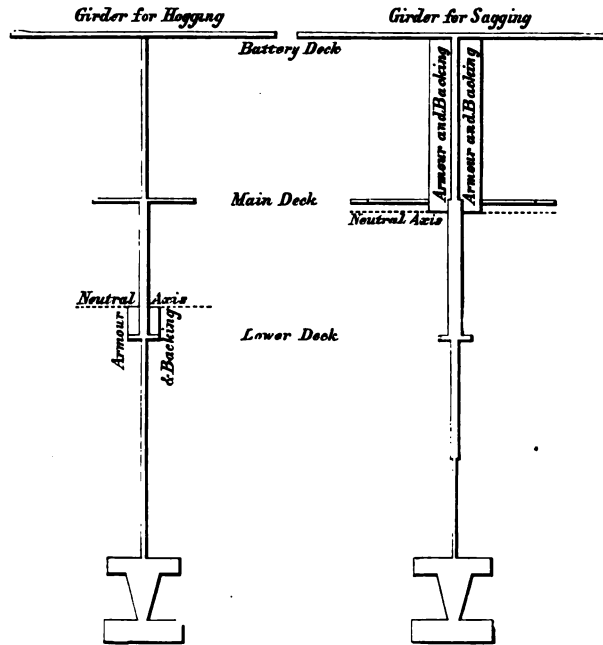

An example, taken from an actual ship, may be of service both as an illustration of the foregoing remarks respecting the relative importance of the several parts of the structure, and as an indication of the simplicity of the calculations for the equivalent girders of ships. That selected is for a broadside ironclad frigate resembling the *Invincible* class in the Royal Navy. Fig. 127 represents the equivalent girders for this ship when subjected to hogging and sagging strains. The armour is supposed to be efficient only against compressive strains, which is an assumption on the side of safety. In estimating the effective sectional areas of other parts of the

structure the rules explained above have been followed. The bending moments (M) for the extreme positions of support, on wave-crest and astride wave-hollow, were estimated in the manner explained in Chapter VIII., and are introduced in the calculations for the purpose of determining the corresponding maximum stress on the top and bottom respectively.

From the preceding explanations and illustrations it will be obvious that the ratio of the *depth* of a ship to her *length* should exercise great influence upon the provision of longitudinal strength. The moment of resistance of an equivalent girder section like that in Fig. 124 has been shown to be very largely influenced by the depth; while the maximum longitudinal bending moment for a ship is expressed in terms of the product of her weight into the length. Broadly speaking, the shallower a ship is in proportion to her length the greater should be the amount of material contributing to the longitudinal strength; and not unfrequently when the hull-proper is extremely shallow recourse is had to some device for virtually increasing the depth, as is described on p. 377. War-ships of nearly all classes are of greater depth in relation to their length than merchant ships; and this fact, taken in connection with their structural arrangements and distribution of weight and buoyancy, explains the smaller stresses to which the material in war-ships is usually subjected. It must not be supposed, however, that increase in depth *per se* necessarily leads to a diminution in stress; on the contrary, cases may occur where an increase in depth obtained by building a light continuous superstructure, upon a comparatively strong hull, actually leads to an increase in the maximum stress brought upon the material most distant from the neutral axis.* The reasons for this are obvious enough, on consideration of the fundamental equations for the strength of beams, given above; but the following example may assist some readers. A belted ironclad having a depth of 42 feet from the flat keel to the spar-deck amidships, had a strongly plated protective deck, 16 feet below the spar-deck; and calculations were made for the purpose of ascertaining the maximum stresses likely to be brought (1) upon the material in the spar-deck when the sides were intact, and (2) upon the material in the protective deck when the sides above that deck were shot away in action, so that the protective deck became the top of the girder. Under hogging strains the following were the results:—

* Readers desirous of following out this subject may turn with advantage to a paper by Mr. Purvis in the *Transactions* of the Institution of Naval Architects for 1878.

I. With sides and spar-deck intact—

$$\begin{aligned} \text{Total depth of girder} &= 42 \text{ feet} \\ \text{Neutral axis below top} &= 23\frac{1}{2} \text{ ,,} \\ \text{Moment of inertia of} & \\ \text{equivalent girder} & \left. \vphantom{\text{Moment of inertia of}} \right\} = 376,000. \end{aligned}$$

Using the same notation as before, for a given bending moment (M).

$$\begin{aligned} \text{Maximum stress on material} & \\ \text{in spar-deck} & \left. \vphantom{\text{Maximum stress on material}} \right\} = M \times \frac{h_1}{I} = M \times \frac{23\frac{1}{2}}{376,000} \\ & = M \times \frac{1}{16,100} \text{(nearly)}. \end{aligned}$$

II. With sides and spar-deck damaged—

$$\begin{aligned} \text{Total depth of girder} &= 26 \text{ feet} \\ \text{Neutral axis below top} &= 11 \text{ ,,} \\ \text{Moment of inertia of} & \\ \text{equivalent girder} & \left. \vphantom{\text{Moment of inertia of}} \right\} = 210,000 \\ \text{Maximum stress on material} & \\ \text{in protective deck} & \left. \vphantom{\text{Maximum stress on material}} \right\} = M \times \frac{11}{210,000} \\ & = M \times \frac{1}{19,100} \text{(nearly)}. \end{aligned}$$

Hence it is seen that the diminution in the depth produced by breaking the continuity of the lightly constructed top sides, upper deck, and spar-deck actually resulted in a diminution of tensile stress in the ratio of 191 to 161. This diminution in tensile stress was accompanied in this case by an increase in the compressive stress on the bottom plating, the value of which may be easily ascertained, if desired, from the foregoing data. Although our illustration has been taken from war-ships, the point raised is chiefly important in merchant-ship construction, especially in connection with vessels having continuous spar-decks or awning-decks, in which types the bottoms are usually stronger than the upper decks, under the principal hogging moments experienced.

The ratio of *length to breadth* must be considered also in adjusting the amount of longitudinal strength to be given to a ship. For the upright position the breadth influences the effective sectional areas of the decks, bottom plating or planking, etc., included in the equivalent girder. For the extreme "beam-ends" position the breadth becomes the depth. Ships rarely, if ever, are thrown absolutely upon their beam ends, and only reach greatly inclined positions when rolling heavily. For such inclined positions the breadth affects the depths and strengths of the corresponding equivalent girder sections.

Equivalent-girder calculations are usually made for cross-sections at or near the middle of the lengths of ships; because the severest hogging and sagging moments, corresponding to exceptional positions of support for ships afloat or ashore, are usually experienced by these cross-sections. Similar calculations may, however, be made for other cross-sections lying towards the bow or stern, the moment of resistance of the equivalent girder for any section being compared with the bending moment experienced by that cross-section, which bending moment is ascertained from the corresponding ordinate of curves such as MMM in Fig. 110, p. 308. Cases occur where the presence of large hatchways or openings in the deck, or peculiarities in the structural arrangements—such as the discontinuance of protective plating at some cross-section in a central citadel or battery ship—lead to greater tensile and compressive stresses being brought upon the material at cross-sections considerably distant from the middle of the length, than are experienced by the material at the midship section. No general law holds good in these matters, but each case must be separately investigated. Broadly speaking, the diminution of the bending moments from the middle of the ship towards her ends, renders possible some diminution in the strength of corresponding cross-sections as compared with the strength of the midship section. Local strains and other considerations interfere with the application of any general rule, but the fullest association of lightness with strength requires that the shipbuilder shall bestow attention upon the *longitudinal distribution* of the material in a ship.

In deciding upon what reductions of scantlings or thicknesses are possible in the parts lying towards the ends of a ship, the builder has to note two important facts. First, the gradual narrowing of the ship towards the extremities is in itself a cause of decrease in the strength of cross-sections; it lessens the sectional areas of the planking or plating on decks, sides, and bottoms; and not unfrequently, owing to the reduction in girths, there are fewer longitudinal stiffeners at the ends than amidships. Second, when a ship is considerably inclined, the narrowing of the decks produces a virtual decrease in the *depth* of the equivalent girder sections; this may be regarded as the source of a still further loss of strength to the cross-sections lying towards the extremities, which is not in operation when the ship is upright. For the upright position the depth of the equivalent girders in most ships remains practically constant for all cross-sections throughout the length.

These facts, taken in connection with local requirements, have led shipbuilders to make only a small decrease in the thicknesses of the planking, plating, etc., forward and aft as compared with the thicknesses used amidships. In wood ships the thickest outer plank-

ing, the wales, is reduced in thickness towards the bow and stern. In iron and steel ships of the mercantile marine it is customary to maintain the midship thicknesses throughout one-half the length. At the extremities of iron ships it is usual to reduce the thickness of the outer skin by about $\frac{1}{8}$ inch to $\frac{3}{8}$ inch, according to the size of the vessel. For steel ships the corresponding reductions are from $\frac{1}{8}$ to $\frac{3}{16}$ inch. Stringers on the decks are also often narrowed or decreased in thickness towards the ends. Vessels framed on the longitudinal system have, in addition, the depths of their longitudinal frames decreased towards the extremities, and as the girths of the sections become less, the practice is to stop short one or more of the longitudinals. These are the main changes that need be mentioned; they do not effect any considerable difference in the scantlings at the extremities as compared with those amidships, and although some writers have recommended much more marked differences between the central part of a ship and her ends, the general feeling and experience of shipbuilders have not gone in this direction.

Local requirements, as remarked above, exercise a very great influence on the longitudinal distribution of the material, often in a direction exactly opposite to that in which the consideration of the strength of the ship as a hollow girder would lead. Many examples of this will occur to the reader who has an acquaintance with the details of shipbuilding; only two or three can now be mentioned. The plating near the stern in a single screw-steamer, from the girder aspect of the case, might be made as thin as any plating on the ship, but as a matter of fact it is as thick as any, the reason being that the local strains due to screw propulsion require strong plating to be fitted between the stern-post and the stuffing-box bulkhead next before it. Passing to the other extremity of an armoured ship, another instance is found. In order to meet the local strains produced by the chafing of the cables, and rubs or blows of the anchors on the bows, it is usual in ships of the Royal Navy to double the plating for some distance. This additional thickness, of course, adds much to the strength of a ram-bow: but here again, reasoning from the girder, a minimum thickness of plating should suffice.

Very similar remarks may be made respecting the *vertical distribution* of the material in the cross-sections of ships. Reasoning exclusively from the analogy of the equivalent girder, it would be advantageous to decrease the amount of the material near the neutral axis, which could be best done by thinning the skin-plating or planking at that part. Some slight reductions in thickness have been made in many cases, but there are other considerations which require to be taken into account before proceeding far in this direc-

tion. Ships frequently occupy inclined positions, and then side plating or planking which is included in the "web" of the equivalent girder for the upright position, may be so placed as to be capable of yielding the greatest assistance to the structure. In iron and steel ships the common practice is to keep the greater part of the skin-plating of uniform thickness, fitting a few thicker strakes on the bottom below the bilges where the severe local strains due to grounding are principally felt, and thickening or doubling the sheer-strakes. Wood ships usually have their *thickest* planking (the "wales") in the neighbourhood of the middle of the depth, where it can be least effective against longitudinal bending strains when the ship is upright. These wales were probably the outgrowth of the rubbing strakes formerly fitted near the main breadth, and they also formed strong ties above and below the lines of ports in many classes of wooden war-ships, thus restoring, to some extent, the loss of strength due to the want of continuous longitudinal planking in wake of the ports.

Modern war-ships have their structural arrangements very much controlled by the necessity for protecting certain parts by armour. The general considerations based upon the comparison of a ship to a girder are, therefore, to a large extent, overruled, material being massed in flanges formed by decks near the middle of the depth, or thrown into the centre of the web of the girder for the upright position, instead of being added to the upper part or to the upper deck: For instance, to increase the resisting power of the target formed by the armoured side, the skin-plating behind the armour is often made about twice as thick as the bottom plating, although its situation is frequently not very favourable to its efficient contribution of longitudinal strength. The strongly plated decks, fitted a few feet above water (as in the belted ships) or at a moderate distance below water (as in the central-citadel type), do not contribute to the longitudinal strength to the same extent as the same weight of material differently distributed might do. The armour plating itself also, even when arranged and fastened with the utmost care, must be regarded rather as a load carried by the structure than as adding much to the longitudinal strength.

From the preceding remarks it will appear that, although the comparison of a ship to a girder in her resistance to longitudinal bending is of great service to the shipbuilder, it only holds good within certain limits. Keeping this in view, we now propose to sketch the character of the principal structural arrangements, which supply longitudinal strength to different classes of ships, and to contrast the relative efficiency of those arrangements. Wood ships, iron and steel ships, and composite ships will come under review, as

well as armoured ships. It must be understood that no endeavour will be made to describe the structural details of any class; for these the reader must turn to works on shipbuilding. To illustrate the contrast between these classes, and to assist our explanations, Figs. 128–131 have been prepared. The former shows, in cross-section and inside elevation, the construction of a wooden ship according to the former practice of the Royal Dockyards. Fig. 129, p. 362, shows, in cross-section, the construction of an iron or steel merchant ship with a single bottom. Fig. 130, p. 369, shows, in

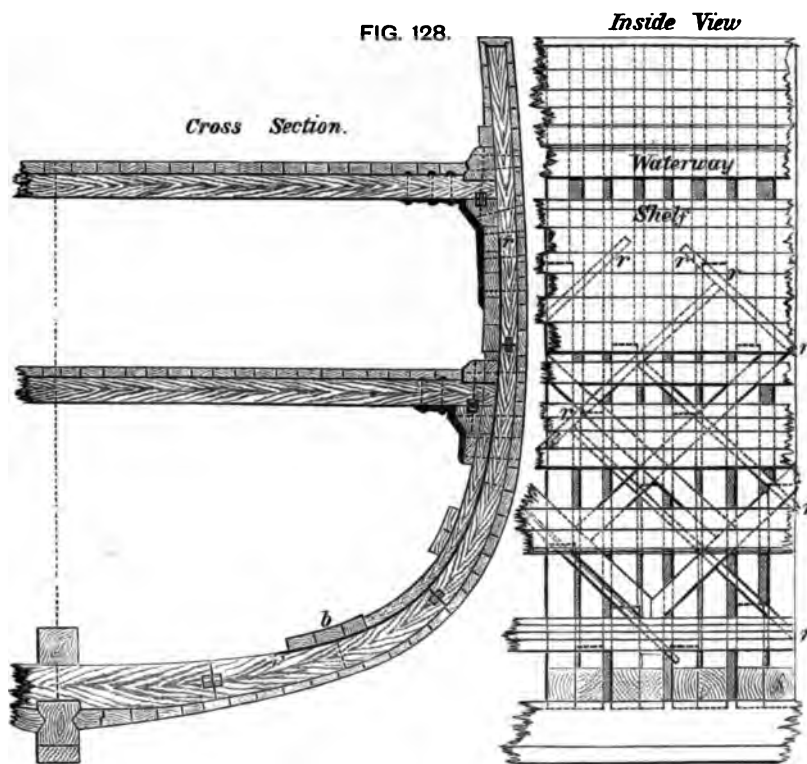

cross-section, the construction of an ironclad ship of the “central-battery” broadside type. Fig. 131, p. 372, shows, in cross-section, the construction of an iron or steel merchant ship, with cellular double bottom. Repeated references will be made to these figures, and their principal features will be noted in connection with the contribution of individual parts to the general structural strength.

First, as to the *upper flange* in the equivalent girder for ships.

The parts ordinarily included for wood ships are as follows: the deck-planking, allowing for its effective area in the manner explained

above; the "shelf-piece" under and the thick "water-way" upon the beam ends. Such a flange is much less strong against the tensile strains brought upon it by hogging than it is against the compressive strains due to sagging, the effective area against tensile strains being less than three-quarters of that against compressive strains. It is a matter of common experience that, under severe hogging strains, signs of working and weakness displayed themselves in the upper works of large wood ships. In order to add strength to the upper

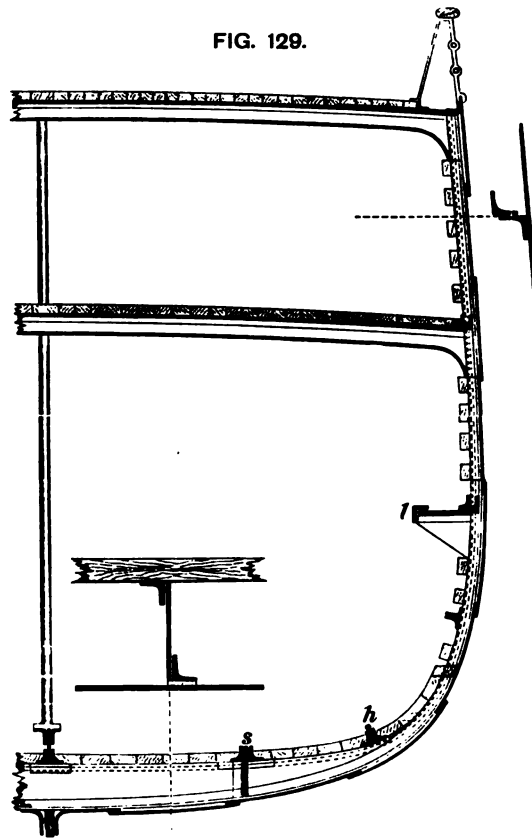

deck, iron stringers and plating were worked under the wood planking in many of the later wood-built ships of the Royal Navy.

In iron, steel, or composite ships the upper flange of the equivalent girder resembles that described for the later wood ships. Fig. 129 shows one arrangement suitable for small ships. The stringer plates on the beam ends are drawn in strong black lines under the wood planking. These stringers should always be strongly secured to the uppermost strake of the side plating (termed the

“sheer-strake”), which is often made thicker or doubled, for the purpose of increasing the longitudinal strength. Composite ships, although they have not an iron skin, are usually fitted with deck-stringers and sheer-strakes.

Early iron ships were often built with no plating on the upper decks, the arrangements of deck-planking and water-ways being similar to those in wood ships. Then stringers and tie-plates were introduced; and, as ships increased in sizes and proportions, completely plated decks were fitted. Now it is not uncommon, in the largest iron and steel ships, to find all the decks completely plated. This arrangement is of the greatest value to the structural strength; and has prevented weaknesses which were of common occurrence in earlier ships of much less dimensions, but without plated decks. Wood planking is laid over the plating in passenger-steamers; in cargo-vessels the deck-plating is often left uncovered. From the first the iron-built armourclads of the Royal Navy have been fitted with plated decks, covered by wood planking. It will be understood, from the remarks made on p. 350, that within certain limits the wood and plating can act together in resisting tensile or compressive stresses. At the same time the wood decks were fitted chiefly for comfort or for sanitary reasons, and not primarily for purposes of structural strength. In the *Great Eastern* exceptional strength was provided at the upper deck, which was a cellular structure formed by two strong iron skins worked above and below deep longitudinal girders. There were no transverse beams such as are generally fitted to the decks of ships, and the longitudinal girders were effective both against longitudinal bending and as stiffeners to the skins, especially under compressive strains. In the largest vessels since built there has been no necessity to imitate this cellular construction of the upper deck, and the simpler, lighter, and less costly arrangement above described has been found to answer all requirements.

Next, as to the *lower flanges* in the equivalent girders of the different classes of ships.

In wood ships the parts included in the lower flange vary considerably, according as hogging or sagging strains have to be resisted. The bottom planking up to the bilge, the keel, keelson, and binding strakes (*b*, Fig. 128) are all effective, although not equally effective, against both hogging and sagging strains. It was a common practice to fill in the openings between the ribs, from the keel to some distance above the bilge in large war-ships; and this had a twofold advantage. In case of damage to the bottom planking the fillings kept the water out of the hold; and, moreover, when the vessel tended to hog, and her bottom was brought under compression, the lower part of the frames was made into a practically solid mass

of timber, the fillings offering great resistance to change of form. When sagging took place, and the bottom was brought under tension, the fillings could lend no such help to the pieces lying longitudinally, and the difference was very considerable. In most wood ships the severest longitudinal bending moments were those tending to produce hogging, a fact which made the use of fillings of the greater value. To assist the bottom in resisting the tensile strains due to sagging, iron stringers were fitted in some few cases in lieu of the ordinary thick binding strakes; but this arrangement was not so efficient as the use of iron strengthenings to the upper deck.

In iron or steel ships without double bottoms the bottom flange of the girder is made up of the keel, keelson, side keelsons (*s*, Fig. 129), hold stringers (*h*), and the bottom plating. These are all effective against both hogging and sagging strains; and, as already explained, the difference in the sectional areas, effective against tension and compression respectively, is not nearly so marked as in the case of the corresponding part of a wood ship. The transverse frames, or ribs, of the iron or steel ship are usually 20 inches to 2 feet apart, there being nothing corresponding to the fillings of the wood ship. Fig. 129 by no means represents the universal practice of shipbuilders in the arrangement of longitudinal stiffeners to the bottom plating. There are very many varieties of side keelsons, hold stringers, keelsons, keels, etc., some builders preferring one arrangement, other builders preferring another arrangement. But they have one feature in common. The *main frames* lie transversely like those of a wood ship, and do not contribute to the longitudinal strength. The longitudinal pieces are supplementary or subordinate to the transverse framing, and are either fitted in between the ribs (like *s*), to secure a direct connection with the bottom plating, or over-ride the ribs (like *h*, Fig. 129).

For wood ships it is practically a necessity to place the ribs transversely, and in the earliest iron ships the arrangements of wood ships were naturally imitated to a considerable extent. The moderate size of the earlier iron vessels rendered unnecessary any longitudinal strengthenings to the bottom other than were furnished by the engine and boiler bearers, fitted primarily as supports to the propelling apparatus. But as the sizes of ships increased, the longitudinal strengthenings to the bottom were multiplied, and in some cases the bottom was thus strengthened, while the top flange of the girder was left almost uncared for, the result being a great disproportion between the strength of the top and bottom flanges. There are, of course, many local strains to be borne by the bottom of a ship—such as those due to grounding, the carriage of cargo, and

possible concentration of weights—which are not paralleled by any strains that have to be borne by the decks; but to give greatly disproportionate strength to either flange involves a bad distribution of the material. The use of iron and steel upper decks and broader stringer plates has partially corrected an evil formerly prevalent in merchant ships, but the upper flange is still in many cases much weaker than the lower. If ships fail, they usually yield to hogging strains; but cases have occurred where the upper flange of the equivalent girder has yielded to the compressive strains incidental to sagging. The shallow-draught steam-ship *Mary*, mentioned on p. 347, is alleged to have foundered in consequence of the upper deck crushing up when she met with heavy weather. A wood deck properly fastened lends great assistance to a thinly plated deck when subjected to compressive strains.

The transverse system of framing iron and steel ships of the mercantile marine has been continued, and will probably be continued, because it facilitates rapidity of construction and is less costly, under ordinary conditions, than the rival system in which the continuous frames are placed longitudinally. No doubt the best combination of strength with lightness is obtained when the main frames are placed longitudinally, at least in the parts of the bottoms below the bilges. On the other hand, the possible saving in weight is not found by private shipbuilders a sufficient inducement to depart from long-established practice. Consequently in ships with single bottoms and transverse frames the necessary strength is given to the lower flanges of the equivalent girders by means of strong bottom plating combined with numerous side keelsons, hold stringers, etc. Many, if not most, of these longitudinal pieces are now fitted "inter-costally"—that is, between the ribs or transverse frames—and attached at their outer edges directly to the skin plating. This is advantageous in many ways. The longitudinal stiffeners thus arranged can assist the skin efficiently, not merely against hogging or sagging strains, but against the strains incidental to water-pressure, grounding, and other causes which have been dealt with in the previous chapter. With these arrangements and closely spaced transverse frames, ample strength has been secured in the bottom flanges of some of the largest merchant steamers yet constructed, in which it has been thought undesirable to introduce cellular double bottoms.

Composite ships resemble most iron and steel ships in having the main frames transverse; and the bottom flanges of their equivalent girders differ chiefly in that they include wood keels and bottom planking. The latter especially loses, as compared with plating, in its resistance to tensile strains due to sagging moments. No

longitudinal frames, the only framing required in the upper parts of ships being vertical and transverse. Such framing stiffens most efficiently the almost upright side plating, gives facilities for attaching the beams to the side, and answers other purposes. The extent to which it is adopted must of course depend upon the special conditions of each class of ship. Widely spaced vertical frames sufficed in the upper parts of the *Great Eastern*; whereas in armoured ships these frames are often very closely spaced, in

FIG. 130.

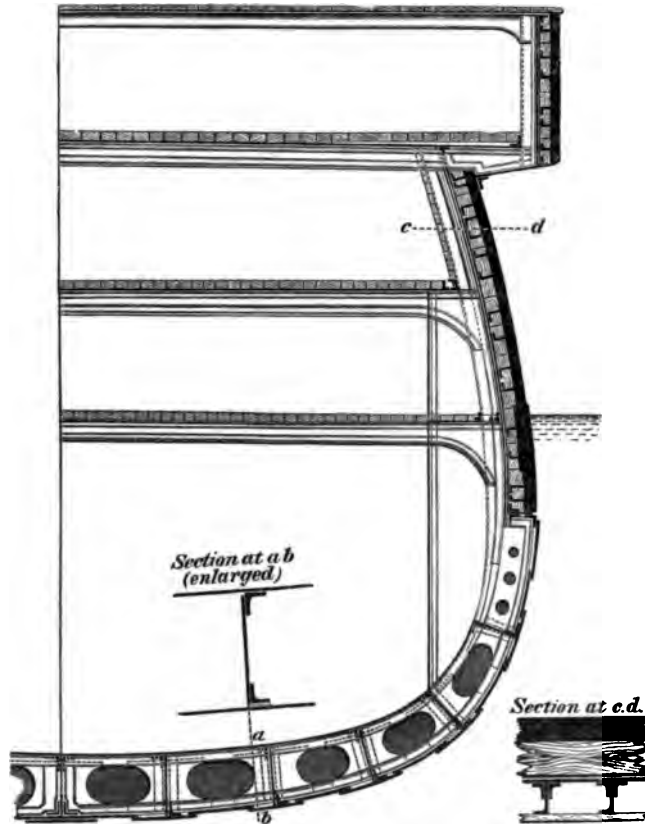

order to assist in strengthening the target formed by the armoured side. Fig. 130 illustrates the last-mentioned case; below the armour the main frames are longitudinal, as shown, but behind the armour the principal frames are vertical, being spaced 2 feet apart (see the section at *cd*). The longitudinal girders worked between the strakes of the wood backing are not fitted primarily with a view to increase the longitudinal strength of the structure, although they have this effect, but are intended to increase the resistance of the

equally intimate connections can be made between the intercostal side keelsons of a composite vessel and the bottom planking, as are possible between such keelsons and the bottom plating of an iron or steel ship. Nor can the composite ship have the help of fillings between the frames like those of a wood ship.

Although the transverse system of framing has been so generally adopted in the mercantile marine, there have been many ships in which longitudinal framing occupied the chief place. The *Great Eastern* was the most notable example, and her structural arrangements, due to the joint labours of the late Mr. I. K. Brunel and Mr. Scott Russell, furnished good evidence of the possibilities of the longitudinal system.* Other and much smaller merchant ships have been built on very similar principles; and in all the large ships of the Royal Navy great prominence is given to longitudinal framing. Such framing is of the greatest advantage in the lower parts of ships. The comparatively flat surfaces of the bottom plating below the bilge are best stiffened against buckling by longitudinal frames, which forms strong girders well secured to the bottom plating, and contribute to the effective area of the lower flange of the equivalent girder for the upright position. At the bilge there is usually considerable transverse curvature in the bottom plating, a fact which gives it great stiffness in itself against buckling under compressive strains; so that at the bilge longitudinal frames are not much required for the purpose of preventing buckling. Very frequently external bilge-keels, fitted just at this part of the bottom primarily to check rolling, also form good stiffeners to the plating, besides adding their own sectional areas to the lower flange of the girder. Above the bilge, and below the lower deck, longitudinal frames are again of great use, especially in adding to the longitudinal strength when the ship occupies an inclined position, and is subject to hogging or sagging moments. For parts of the structure lying above the lower deck, other considerations enter and make longitudinals of less importance; in fact, the decks themselves with their stringers, etc., form most efficient longitudinal stiffeners. Sometimes, where a lower deck does not extend throughout the whole length, but is broken for some reason, its stringer plate is continued in order to form a stiffener, as shown by *l*, Fig. 129. As a rule the decks need no aid from intermediate

* For much interesting information concerning the construction of this ship, and her predecessors, the *Great Western* and *Great Britain*, see the life of Mr. Brunel, published by his son. It is

evident from the details therein given that, at a very early period after the introduction of iron ships, Mr. Brunel perceived the great advantages attaching to longitudinal framing.

longitudinal frames, the only framing required in the upper parts of ships being vertical and transverse. Such framing stiffens most efficiently the almost upright side plating, gives facilities for attaching the beams to the side, and answers other purposes. The extent to which it is adopted must of course depend upon the special conditions of each class of ship. Widely spaced vertical frames sufficed in the upper parts of the *Great Eastern*; whereas in armoured ships these frames are often very closely spaced, in

FIG. 130.

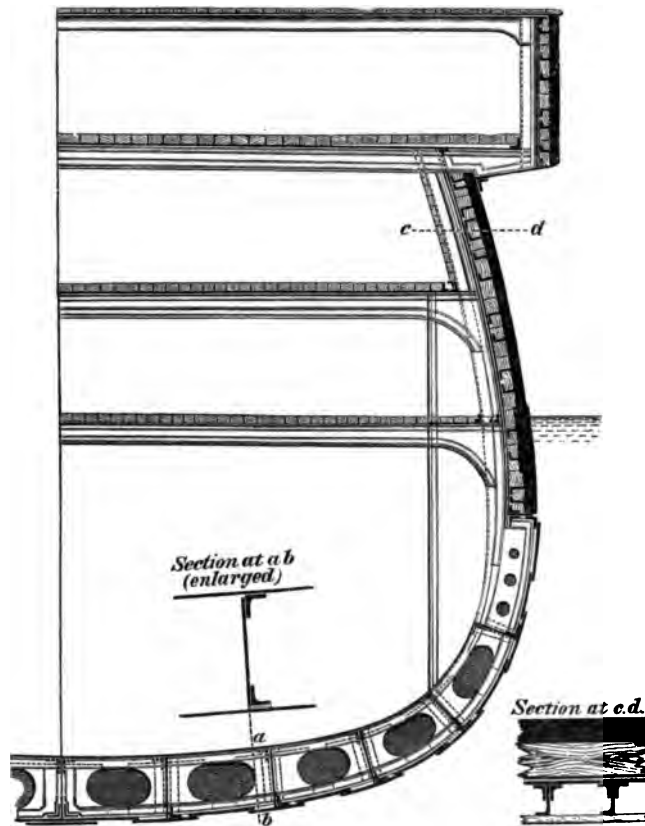

order to assist in strengthening the target formed by the armoured side. Fig. 130 illustrates the last-mentioned case; below the armour the main frames are longitudinal, as shown, but behind the armour the principal frames are vertical, being spaced 2 feet apart (see the section at *cd*). The longitudinal girders worked between the strakes of the wood backing are not fitted primarily with a view to increase the longitudinal strength of the structure, although they have this effect, but are intended to increase the resistance of the

target formed by the side of the ship against penetration or damage by projectiles.

Looking a little more closely into the arrangements illustrated in Fig. 130, it will be evident that the lower flange of its equivalent girder includes the skin plating, both outer and inner, as well as the numerous and strong longitudinal frames. These frames, as already explained, are of great value in preventing buckling under hogging strains or water pressure, and in resisting the tensile strains due to sagging, even when there is only a single outer skin. But their efficiency in these respects and the strength of the lower flange of the girder are both very greatly increased by the adoption of the inner skin plating, forming a double bottom. This cellular construction has been proved by experiment to develop most efficiently the strength of a structure formed of plates and bars, any one of which, taken singly, has little strength to resist bending. This is particularly true under compressive strains, and was first demonstrated in experiments made before the tubular bridge across the Menai Straits was constructed.

Although longitudinal frames play such an important part in connecting the two skins and stiffening the bottom, their direct contribution to the moment of resistance of the equivalent girder section is not relatively great. This will appear more clearly on reference to the exemplar calculations for an armoured ship on pp. 355, 356. The inner and outer skins are the largest contributors to the moment of inertia of the lower flange, and the longitudinals might be left out of the calculation without seriously affecting the result. Their presence in the structure is, however, of great importance; for without them the joint action of the two skins in resisting bending moments would not be secured. In order to give efficiency to longitudinal framing, frequent "sections of support" must be provided by means of transverse bulkheads or "partial bulkheads," as is further explained hereafter. Having made this provision, the amount to which the main longitudinal frames require to be reinforced by subordinate transverse frames, depends upon the necessities of local strength in the bottom. In armoured ships of the Royal Navy the "bracket-frames" are 4 feet apart, and this amount of stiffening to the bottoms is found sufficient to meet all the ordinary strains to which the ships are subjected during construction, launching, docking, or service afloat. In cases of grounding also, although these are rare in war-ships, this bracket-system of construction has stood the stress of service exceedingly well. The *Iron Duke*, for example, grounded twice on the China station, once on a soft bottom and secondly on a rocky bottom. On this second occasion the outer bottom was bulged in, the framing

in the double bottom was bent and broken over a considerable length, but the inner bottom remained intact, and the ship was safely navigated to port after she was got off. The case of the *Apollo*, which struck the Skelligs during the naval manœuvres of 1892, was even more remarkable.

Since 1877 a remarkable extension of the use of cellular double bottoms has taken place in the mercantile marine. The change must be mainly attributed to the enterprise of a few leading shipbuilders, and to the support given to the movement by the professional officers of the Registration Societies. One great reason for this rapid progress is to be found, no doubt, in the more general recognition of the commercial advantages attending the use of water-ballast; the gain in safety has also had some weight, and is becoming increasingly evident to shipowners. Limits of space prevent us from attempting to trace in detail the various methods of construction adopted by different firms, or to contrast these with the corresponding methods of construction in war-ships. All that can be done is to choose a good example of common practice, such as is illustrated in Fig. 131, and to sketch the main features.

Above the turn of the bilge the main frames are vertical and have the usual spacing, about 2 feet. At the turn of the bilge there is a continuous watertight longitudinal frame (AA, Fig. 131), and upon this the vertical frames are stopped short, their heels being connected to the longitudinal by bracket-plates (B). The longitudinal AA has its outer edge connected by a continuous angle-bar to the bottom plating, while its inner edge is similarly connected to the inner skin plating; in this way the longitudinal forms a watertight side boundary to the ballast-tank, or cellular bottom. Within the double bottom the main frames are longitudinal as indicated on the section. The transverse framing consists of "gusset" or "bracket" plates, with angle-bars on their edges and ends connecting them to the two skins and the longitudinals; these bracket-frames are spaced 4 feet apart, just as the corresponding frames in the armoured ships are spaced. Intermediate between the bracket-frames, simple angle-bar transverse frames are fitted (as shown on lower section) to give additional support to the skin-plating, and to provide for taking the ground as merchant ships frequently have to do.

In many cases a different plan of framing is adopted within cellular double bottoms. The main frames are placed transversely about 2 to 2½ feet apart, and formed of plates lightened by holes, with angle-bars on the edges, extending from the keel to the continuous longitudinals (AA, Fig. 131) which form the side boundaries of the double bottom. The longitudinal frames in the double bottom are then worked in short lengths (intercostally) between the transverse frames.

Very similar arrangements have been carried out in some cruisers of recent construction and of moderate dimensions. The discontinuity of the transverse framing at the side boundaries of the double bottom requires to be carefully provided for, and when this is done no difficulty arises in the maintenance of transverse strength. Above the

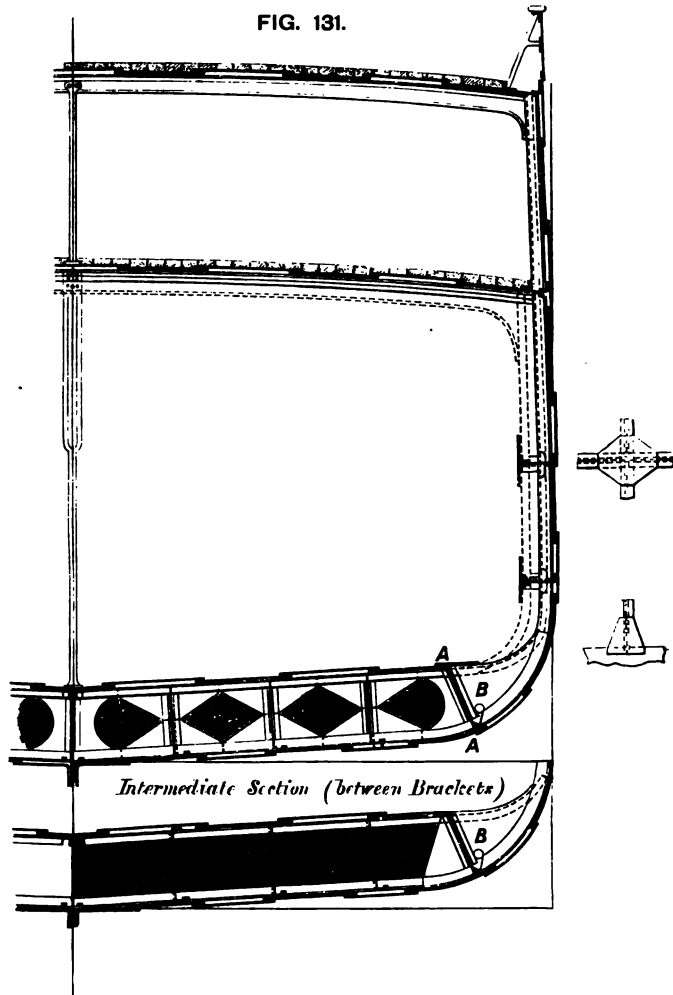

side longitudinals (AA) deep transverse frames or partial bulkheads are commonly fitted at intervals of 10 or 12 feet, and carried up to the lowest complete deck. The outline of such a strengthener is indicated by dotted lines in the diagram.

From this brief explanation it will be seen that the cellular system now widely used for merchant ships, although similar in

principle, differs in details from the longitudinal system previously described for armoured ships. The greater amount of support given to the bottom is desirable in merchant ships, which have to take the ground. Experience has shown that a vessel can be built on this cellular system, and given all the advantages of a water-ballast tank, as well as greater safety, with no greater weight of material than would be used in a vessel of the same dimensions built on the ordinary transverse system. The cost of workmanship in the cellular system is probably somewhat greater than in ships with a single bottom. Cellular double bottoms necessitate the sacrifice of some of the hold-space as compared with the transverse system of framing without any provision for water-ballast. But as compared with other methods of forming water-ballast tanks, the cellular system is more simple and efficient, while it takes less away from the hold-space. One very common arrangement for water-ballast consisted in building upon the floors a series of longitudinal girders which carried an inner skin, extending across the ship from bilge to bilge, and connected in a watertight manner to the outer bottom plating. These ballast-tanks, or partial double bottoms, answered fairly well, and the material used in their construction contributed somewhat to the general structural strength; but not nearly to the same extent as the material in the cellular bottoms. It is now not uncommon to find the cellular system applied throughout the whole length of a ship, in order to gain the greatest power of controlling the trim by the admission of water-ballast into the spaces near the extremities. In many cases, however, the double bottoms of merchant ships only extend over portions of the length.

Continuing the investigation of the equivalent girders for different classes of ships, attention must next be directed to the *webs or vertical portions*, marked EE in Fig. 124.

In ordinary wood ships the outside and inside planking is worked in one thickness, as shown in Figs. 125 and 128. The individual planks or "strakes" are comparatively narrow, the numerous butts and edge seams being caulked. This planking, with the water-way and shelf-pieces under the beams, and the diagonal strengtheners, form the web of the girder. The ultimate strength of these parts against cross-breaking strains is no doubt ample in all or nearly all cases; and what has to be regarded is rather their strength to resist the *racking* strains which always accompany bending.

Reverting to the case of the beam discussed on p. 351, it will be seen that, although the total of the tensile forces experienced by any cross-section equals the total of the compressive forces, these two resultants act in opposite directions, and therefore tend to *rack* or distort the beam, this racking strain reaching its maximum at the

neutral surface, and gradually decreasing to nothing at the top and bottom of the beam. So long as the beam is in one piece, or so long as the pieces forming its web are well connected together edgewise, there is no difficulty in meeting this racking strain. But if a beam were constructed of which the web consisted of strakes or narrow planks placed edge on edge, and having little connection edgewise, then obviously, as the beam bent, these planks would be made to slide upon one another by the racking strains.* And if these strakes were crossed at right angles by ties, corresponding to the ribs or timbers of a wood ship, these ties would add little to the strength of the web against racking. For (to quote the well-known illustration of Sir Robert Seppings), if a field-gate be made of pieces all lying parallel or at right angles to one another, its resistance to distortion of form will be very small. On the contrary, if the strakes forming the web are crossed by diagonal ties—corresponding to the cross-bar of the gate—there will be a great addition to the strength of the combination against racking and distortion of form.

Such are the simple principles upon which the use of diagonal “riders” or ties in wood ships was principally based. The side planking above the bilge has in itself little strength to resist racking strains; and in many cases these strains have been so severe as to show marked evidence of their action. When the line-of-battle ship *Cæsar* stopped on the launching ways and broke considerably, it was in the planking near the middle of her depth that working was most apparent; the diagonal riders also showed signs of severe straining. Moreover, it is a matter of common observation that, when the caulking of the seams of planking in a wood ship becomes slack and needs renewal, she is much more liable to working longitudinally. This circumstance is easily explainable, seeing that, when well caulked, there is a much greater resistance to the relative motion of the planks which racking strains tend to produce. Diagonal riders furnished, however, the best corrective for this source of weakness, when a single thickness of planking was worked.†

When first introduced into the Royal Navy by Sir Robert Seppings, early in the present century, these riders consisted of massive timbers, worked inside the transverse ribs of the ship. Subsequently iron-plate riders were substituted for the timber riders, and with very great advantage. In Fig. 128 these riders are indicated in

* For a well-known illustration of the above statement, the reader may turn to the springs of railway-carriages.

† In some small vessels built by the late Mr. Ditchburn, bolts were driven

edgewise through adjacent strakes of the skin planking, in order to prevent racking. A similar plan of bolting is sometimes adopted in certain portions of the bottom planking of ordinary wood ships.

both the cross-section and the inside view, being marked *r, r*. It will be observed that they are worked *inside* the ribs, and inclined 45 degrees to the vertical. Wood-built merchant ships are usually furnished with similar iron riders, which are often worked *outside* the timbers; and that arrangement has some advantages in point of strength, although it is not so convenient to execute during the construction of a ship. Whether fitted inside or outside, the riders are usually inclined so that their upper ends slope towards the midship section of the ship; near the middle of the length (as shown on the inside view, Fig. 128) the two systems of riders belonging to the fore and after bodies respectively are made to cross each other at right angles. In some cases where special strength was desired, this duplicate arrangement of the riders has been carried right fore and aft; but the more common plan was to have one system only. It will be observed that, as usually arranged, these iron riders are very efficient aids against hogging strains, which are those most injurious to wood ships. When hogging takes place, the ends must drop relatively to the middle, a change of form which would bring the iron riders under tensile strains, the kind of strains which they are best fitted to resist. Against compressive strains these thin narrow bands of iron cannot be nearly so efficient as against tensile strains, so that, as commonly fitted, riders are not of much service against sagging strains, except amidships, where the two systems overlap one another. It is amidships that the severest strains are experienced, so that the crossing of the riders there is a great advantage.

Composite ships of the mercantile marine were usually built with a single thickness of planking, and consequently needed diagonal strengtheners. One common plan of fitting these was to have rider plates riveted outside the iron frames, and inclined 45 degrees to the vertical. The upper ends of those riders were attached to the sheer strake, and the lower to another detached longitudinal tie, formed by a strake of plating worked at the bilge.

Composite ships of the Royal Navy are built with their outside planking in two thicknesses. The edge-seams of the planks in the inner thickness are each covered by a plank of the outer thickness; the seams of the outer thickness are similarly covered by the planks of the inner thickness. A strong edgewise connection is thus made in the double skin, and consequently diagonal rider plates are dispensed with. Other composite ships have been constructed with the skin planking in two thicknesses, one or both of which had the planks worked diagonally; it was then unnecessary to fit diagonal rider plates to assist the skin against racking strains.

This diagonal system of planking has also been adopted in some special classes of wood ships with great success. The royal yachts

are examples of this system of construction. Three thicknesses of planking are employed, the two inside being worked diagonally, and the outer one longitudinally. The two diagonal layers are inclined in opposite directions, and the skin thus formed possesses such superior strength to the skin of an ordinary wood ship that there need be comparatively little transverse framing above the bilges. Direct experiments with models, and the experience gained with ships thus built demonstrated its great superiority in the combination of strength with lightness. The royal yacht *Victoria and Albert*, built on this plan, with her unusually powerful engines and high speed, although subjected to excessively great sagging moments (see p. 317), has continued on service for forty years with complete exemption from signs of weakness. Like many other improved systems of construction, this was found more expensive than the common plan; but if wood had not been so largely superseded by iron and steel, much more extensive use would have been made of the diagonal system. Large steam and sailing launches employed in the Royal Navy are still built on a somewhat similar plan; the skin planking is in two thicknesses worked diagonally, with the two layers inclined in opposite directions. These boats answer admirably, and have frames only on the flat of the floor, where the wear and tear of grounding have to be borne.

Iron and steel ships have outer skins formed by numerous plates, each of which is strongly fastened at the edges, as well as the butts, to the plates adjacent thereto. Such a combination is very strong against longitudinal racking strains, and needs no supplementary strengthening such as the diagonal riders of wood or composite ships. Many proposals have been made, and several plans have been patented for using diagonal strengthenings in iron ships, the superiority of an iron skin, and its capability of resisting and transmitting strains in all directions, not having been apprehended. From the bilges upwards, the outside plating forms the principal part of the web of the equivalent girder section in ships like that in Fig. 129, p. 364; and when properly stiffened, it acts this part most efficiently when the ship is upright. When she is considerably inclined, some parts of the same plating contribute strength to the flanges of the girder-section for that position, as already explained. Vessels with double bottoms extending far up the side, or with wing-passage bulkheads like that in Fig. 130, p. 369, gain much on vessels with single bottoms, since the additional skin contributes to the strength of the web of the girder for the upright position, and to the strength of the flanges of the girders for inclined positions. Any other longitudinal bulkheads which extend over a considerable length in the ship may also be regarded as contributing

to the longitudinal strength, and one of the most valuable additions of this kind that can be made to a ship is a middle-line bulkhead like that shown in Figs. 22-29, p. 32, for an ironclad of recent type. The longitudinal bulkheads fitted in the *Great Eastern* added greatly to her longitudinal strength. Such bulkheads are, however, generally fitted with a view to increase in safety or accommodation; the increase in structural strength is a secondary consideration.

Mention may be made, in passing, of a plan upon which a few iron ships have been built, intermediate in character between ships with transverse frames and others with longitudinal frames. The main frames in these special vessels were placed diagonally, somewhat after the fashion of riders, and therefore crossed the probable lines of fracture of the plating in ordinary iron ships, which line, it has been said, would lie in a transverse plane. It was hoped, thereby, either to divert the line of fracture from this transverse plane to some longer and stronger diagonal line, or else to make the diagonal frames add to the strength of the transverse section which gives the smallest effective sectional area to the bottom plating. The plan has not found favour with shipbuilders, nor is it comparable to the longitudinal system, in cheapness and simplicity of construction or in combination of lightness with strength.

Vessels designed for service in shallow waters often have their hulls strengthened longitudinally by girders. It has been shown that the *depth* of any cross-section of a vessel has a great influence upon the amount of its resistance to bending strains; and in these special vessels the depths of the hulls are so small as to render supplementary strengthenings essential. The American river steamers before mentioned furnish good examples. Their wood hulls were extremely shallow, and had to carry an enormous superstructure of saloons, etc., although they had in themselves little longitudinal strength. To supply this, a "hog frame" was constructed. It consisted of a strong side keelson fitted along the flat floor of the vessel, at some distance out from the keel. Upon this keelson were erected a series of timber pillars, and along over the heads of the pillars a strong continuous timber beam or tie was carried, diagonal struts being fitted between it and the keelson. A light but strong timber girder of considerable depth was thus firmly combined with the shallow hull, and made to help it efficiently against hogging. In other light-draught vessels built for river or coast service, with iron or steel hulls, arrangements have been adopted similar in principle to the foregoing, iron or steel lattice girders having been substituted for the more cumbrous and less efficient hog frame. These vessels, being designed for smooth-water service, are not subjected to longitudinal strains of so severe a

character as those experienced by ships at sea, and, what is still more important, their strains remain nearly constant in character as well as intensity. Hence their case is much more easily dealt with in the manner described, than is that of a seagoing ship which has to bear rapid and extreme variations of longitudinal bending strains while in addition she may be rolling from side to side. At the same time, there is considerable range for the exercise of ingenuity in securing the lightness of construction demanded by shallow draught. The conditions of the problem resemble more closely those of bridge construction than those connected with the construction of seagoing ships, with which we are more especially concerned.

Figs. 132 and 133 furnish illustrations of this class; being respectively a side view and cross-section of a tug-boat built for the Godavery river from the designs of the late Mr. J. R. Napier.* The draught of water was not to exceed one foot; it was consequently necessary to make the structure as light as possible, and steel was used. The hull proper was that of a shallow open boat, about $3\frac{1}{2}$ feet deep; it was formed, as shown in Fig. 133, of steel plates $\frac{1}{8}$ inch thick, with each strake of plating stiffened by a longitudinal angle-bar. The transverse frames consisted of angle-bars, spaced 9 feet apart, and therefore quite subordinated to the longitudinal frames. The hull proper, being so shallow and without a deck, could not contribute the necessary longitudinal strength; but this was obtained in a very ingenious manner. An awning was necessary to furnish protection from a vertical sun and tropical rains; it is marked α, α in the diagrams, and is about 10 feet above the bottom. To convert this into an efficient upper flange, it was formed of steel plates $\frac{1}{16}$ inch thick, each strake being stiffened by a longitudinal angle-bar. Transverse angle-bars were fitted, 9 feet apart, vertically over the corresponding transverse frames of the hull, and diagonal braces (c, c , Fig. 133) connected the corresponding transverse stiffeners to hull and awning, preventing the latter from being pulled or blown over. Lattice girders (b, b , Fig. 133) formed by diagonal and vertical bars, as shown in Fig. 132, were fitted on each side to strengthen the connection between the awning and the hull, and to enable them to act together in resisting longitudinal bending. The diagrams explain further particulars. The vessel was driven by paddles placed under the sloping stern; the boiler was placed at the bow, where there was also a steam capstan; and

* The drawings and particulars are taken from vol. viii. of the *Transactions of the Institution of Naval Architects*.

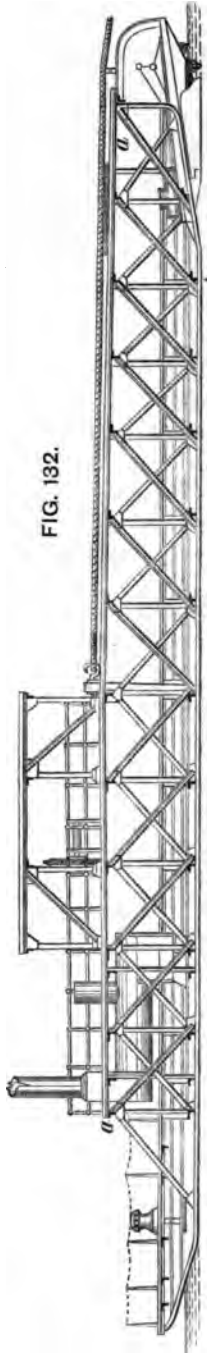

FIG. 132.

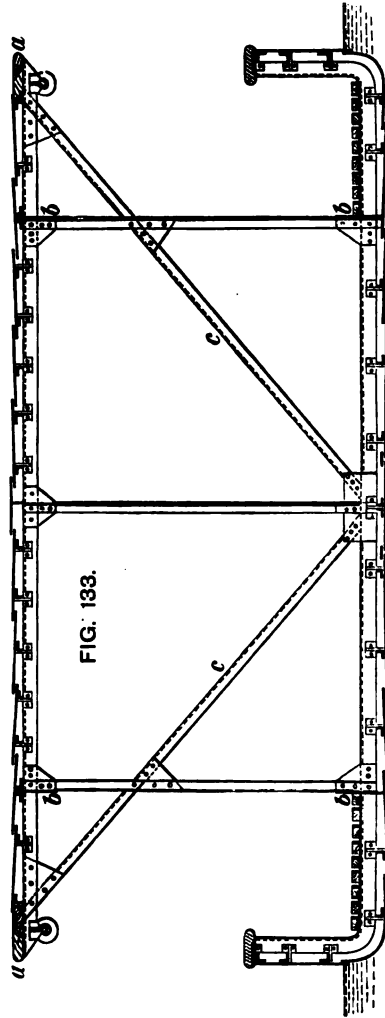

FIG. 133.

the tow-rope was secured near the middle of the length and led along over the awning.

Results of Calculations of Longitudinal Strength.—The comparison of a ship to a girder in her resistance to longitudinal bending is extremely useful in connection with structural arrangements; and the construction of the “equivalent girder” enables a fair approximation to be made to the moment of resistance to longitudinal bending at any selected cross-section of a ship. It is necessary, however, clearly to recognize the assumptions made in these processes of calculation, and not to treat them as rigorously exact or as including all the conditions of practice. For instance, in an equivalent-girder calculation, such as that on p. 355, it is taken for granted that the various parts of the structure are combined and supported so that they can act together. In practice, if the builder does not provide proper connections, or adequately meet local strains, “buckling” or other local failure may occur, the ultimate strengths of the various parts of the structure may not be developed, and the comparison to a well-constructed girder does not hold. Moreover, in a ship at sea the problem is made much more complicated than in bridge or girder work, by the movements of the vessel and the action of the waves upon her hull. A bridge or girder is fixed, and, although it is exposed to the action of the wind, to variations of temperature, and to both “dead” and moving loads, it is possible to approximate to the worst conditions it has to resist, and to provide a reasonable margin of strength. Experience is of immense value in determining this margin, but mathematical calculations are essential to all new departures. A ship at sea, rolling and pitching among waves, is simultaneously subjected to longitudinal, transverse, and local strains, of which a description has been given in the preceding chapter. Many of the pieces in her structure have to assist in simultaneously resisting all these strains; and it has been shown that exact estimates of their magnitude are scarcely possible. Hence it follows that purely theoretical calculation, based upon the equivalent-girder method, cannot be trusted in determining the scantlings of various portions in the structures of ships. The calculations which can be made are of value, especially for purposes of comparison between different ships, or the analysis of structural strength in a particular ship. They require, however, to be associated with the results of experience gained on service with actual ships. Some of the best lessons in structural arrangements have been derived from failures which made apparent weaknesses or disproportionate distributions of strength, that might not otherwise have been suspected.

Keeping in mind the foregoing considerations, attention may

now be turned to some of the calculations made for the strengths and stresses of various classes of ships. Much work of this kind has been done during the last twenty years for iron and steel ships belonging both to the Royal Navy and to the mercantile marine. In these calculations the *maximum bending moments* are estimated in the manner described on p. 313, for the two extreme positions of support illustrated by Figs. 113 and 114. These estimates, it has been shown, probably assign greater values to the bending moments than are experienced in practice. The equivalent girder is constructed, and its moment of resistance to bending estimated (as described on p. 348) for the weakest section nearly amidships. Having this *data*, the corresponding maximum tensile and compressive stresses on the material can be determined by the formula given on p. 354. These stresses are obviously not to be regarded as actually occurring in all cases, or being frequently experienced in any case. Ships may be long at work, and not meet "end-on" waves of the critical dimensions assumed. Ships of great length are less likely to do so than are shorter ships.

For war-ships calculations made in the manner described show stresses on the material of comparatively moderate amounts. In armoured frigates of the *Minotaur* type, for example, the maximum tensile stress on the upper deck, when the vessel is balanced on a wave crest, was found to be only 5 tons per square inch of sectional area, or about *one-fourth* the ultimate tensile strength of good iron plates such as were used in those ships. In the central citadel type (No. 6, in the table on p. 317), the maximum bending moment occurs when astride a wave hollow; and the corresponding maximum tensile stress on the bottom was found to be $5\frac{1}{2}$ tons per square inch, or about *one-fifth* of the ultimate tensile strength of good steel plates. In the turret-ram and belted cruiser (mentioned in the same table), the maximum stress on the material was found to be only from 2 tons to $2\frac{1}{2}$ tons per square inch; and in the *Devastation* class, only $1\frac{1}{2}$ ton per square inch. In the *Royal Sovereign* class, the maximum stress was found to be $3\frac{1}{2}$ tons per square inch when the vessel was on a wave crest.

In these estimates the armour has been treated simply as a burden, not contributing to the structural strength, although it really does so to some extent. These examples show that armoured vessels have ample strength against all the principal longitudinal bending strains. Their hulls are constructed comparatively lightly, yet if the scantlings were determined solely with reference to the longitudinal bending strains, in many cases they might be still further reduced. The lower limit of scantlings in these vessels is, as a matter of fact, determined chiefly by the strength necessary

to resist local strains, and by considerations of durability. It will not be overlooked that the necessities for protection in the form of armoured sides or thick decks exercise great influence over the distribution of much of the material in these classes of ships, and curtail the possibilities of the designer.

Unarmoured war-ships have also been found to have very moderate stresses under the assumed conditions. The *Iris*, for example, although very lightly built of mild steel, has a maximum tensile stress of 5 tons per square inch on the material in the upper deck, and a smaller compressive stress (4·6 tons) on the material in the bottom, when balanced on a wave crest. The swift cruiser, *Blake*, has a maximum tensile stress of 4·7 tons per square inch when similarly circumstanced.

These moderate calculated stresses for all classes of iron and steel-hulled war-ships have been accompanied by a practical absence of any serious signs of working or weakness under longitudinal bending strains. With very few exceptions, it may be said that there has been an entire absence of any such signs, and no indication of the need of greater scantlings for successfully withstanding the strains experienced when afloat.

Corresponding calculations for merchant ships of all classes are now accessible. The results are very diverse, as might naturally be anticipated from the great differences between various types.* In the smaller classes the scantlings found necessary to give sufficient local strength and durability provide an ample margin of longitudinal strength according to the equivalent girder method. The calculated stresses for these smaller vessels are often very small; whereas in the larger vessels they are much greater than the corresponding stresses in war-ships. The late Mr. W. John, whose labours in this department were most valuable and extensive, published the following figures in 1874, for types of iron ships then afloat, as illustrations of the increase in maximum strain accompanying increase in dimensions. All these ships were supposed to be about eight beams, and eleven depths in length, and their scantlings agreed with the then current practice for first-class vessels. The maximum bending moment was assumed to occur on a wave crest, and to equal one-thirty-fifth of the product of the weight of a ship into her length.

* See papers in the *Transactions* of the Institution of Naval Architects for 1874, 1877, 1878, and 1892; in the *Transactions* of the Institution of Engineers and Shipbuilders in Scotland for

1878; and in the *Transactions* of the North-East Coast Institution of Engineers and Shipbuilders for 1889, 1890, and 1893.

Register tonnage of vessel.	Maximum tension on the upper works.
	Tons per square inch.
100	1·67
500	3·95
1000	5·19
1500	5·34
2000	5·9
2500	7·1
3000	8·1

Other examples showed that if the proportions of length to breadth and depth were increased, the vessels were subjected to greater stresses; and in one vessel over 400 feet long a maximum stress of nearly 9 tons was found. Vessels having less proportions of length to breadth and depth sustained smaller stresses.

The general adoption of plated decks in iron and steel ships of more recent construction has been most advantageous. Material has thus been added to the upper flanges of the equivalent girders, which were formerly weak in proportion to the lower flanges. The neutral axis has also been raised. Formerly that axis was often situated only from 30 to 40 per cent. of the total depth above the bottom of the equivalent girder for hogging moments. Consequently the material in the upper flange was about twice as far distant from the neutral axis as the material in the lower flange. As the stress on the material, within the limits of elasticity, is proportional to the distance it is placed from the neutral axis, for a given hogging moment the tensile stress on the upper deck was about twice as great as the compressive stress on the bottom. Such a great disproportion of stresses was objectionable, and has been much reduced by the changes in practice above mentioned. In war-cruisers it does not exist, the distribution of material bringing the neutral axis very nearly up to the middle of the depth of the equivalent girder, and making the tensile and compressive stresses approximately equal. The same thing is true in many modern merchant steamers. But it is also true that in some types the old disproportion of stresses remains. Cases may occur in which the most serious strains with certain cargoes correspond to sagging moments astride wave hollows, and in which (owing to the low position of the neutral axis) the material in the upper decks is subjected to large compressive stresses in proportion to the simultaneous tensile stresses on the bottom. This is a most undesirable condition, since the deck-plating is far better adapted for resisting tension than compression.

The calculated stresses on the material in iron and steel merchant

ships, for the two extreme hypothetical positions of support among waves, depend upon the stowage of cargo assumed and upon the structural arrangements. Homogeneous cargoes just filling the hold-spaces are generally assumed. But there are many types of cargo-steamers, each with special structural arrangements, and consequently generalizations are not possible respecting the intensity of the stresses. The following facts are of interest. In a number of cargo-steamers 300 to 350 feet in length, having about 8 to 9 beams and 11 to 12 depths in their length, the maximum stresses (tensile for wave crest) have been found to vary from $3\frac{1}{2}$ to $6\frac{1}{2}$ tons per square inch. Vessels of approximately the same dimensions and proportions, but differently constructed and varying in their speeds and coefficients of fineness, have been estimated to be subjected to tensile stresses of 8 to $9\frac{3}{4}$ tons per square inch. A tank steamer of the "shade-deck" type, 345 feet long, $45\frac{1}{4}$ feet broad, and $35\frac{1}{4}$ feet depth (to shade-deck), has had her condition examined carefully.* With oil stowed principally amidships, the maximum stresses occur astride the wave hollow; they vary from about 6 to 7 tons per square inch (compressive), and from $5\frac{1}{2}$ to $7\frac{1}{2}$ tons (tensile), according to the assumptions made as to the upper flange of the equivalent girder. With an ordinary cargo, less concentrated amidships, the stresses are less serious, varying from $2\frac{1}{2}$ to $3\frac{1}{2}$ tons per square inch. In a Transatlantic passenger-steamer, about 500 feet long, 52 feet broad, and $33\frac{3}{4}$ feet deep, the maximum tensile stresses were estimated at $6\frac{1}{2}$ tons per square inch. On the whole, these recent calculations in most cases show proportionately less values for the stresses than were obtained by Mr. John for steamships built twenty years ago. Similar calculations have been made for sailing ships. In examples having lengths of 210 to 230 feet, the maximum tensile stresses have not exceeded $3\frac{1}{2}$ tons per square inch.

Attempts have been made to deduce practical rules from the comparison of stresses estimated on the equivalent-girder method, with the results of actual experience. For iron ships built to class at Lloyd's, the late Mr. John summarized the results of his investigations as follows: When local strains have been properly met, and ships have been well built, the calculated maximum tensile stresses on the upper works may reach 6 to 7 tons per square inch, without any sign of weakness. Calculated tensile stresses of 7 to 8 tons per square inch are occasionally associated with some signs of weakness; when these stresses reach 8 to 9 tons per square inch, experience shows that strengthening becomes absolutely necessary. In a fixed

* See a paper by Mr. Kendall, in *Coast Institution of Engineers and Shipbuilders for 1892-93*.

iron bridge the corresponding stresses under the maximum working load to be frequently carried would not be allowed to exceed 4 to 5 tons per square inch. But as explained above, the comparison of ships to girders cannot be treated as absolute, nor the stresses calculated on the equivalent-girder method as exact. At the same time, this method of analysis and comparison is of great service in determining the scantlings of ships of new types, on the basis of past experience with other ships.

Transverse Strength.—The strength necessary to prevent changes in the transverse forms of ships is chiefly provided by the following parts of the structures: (1) the transverse frames or “ribs”; (2) the skin plating or planking; (3) the decks, including the beams, plating, and planking thereon; (4) the pillars or other supports to the decks; (5) transverse bulkheads and partial bulkheads.

As a simple illustration of general principles, take the case of a single-bottomed ship framed on the transverse system illustrated by Fig. 129, p. 364. Conceive two imaginary planes of division to be drawn, midway between any transverse frame and the frames adjacent to it on either side. These planes will cut off a strip of the skin plating, having a length fore and aft equal to the frame-spacing, and along the centre of this strip will be secured a “rib.” Similarly, on each deck a strip of planking or plating of equal length will be cut off; and, if a beam is fitted at the selected frame, this beam will form a stiffener to the strip of planking or plating. Consequently the portion of the ship supposed to be cut off may be regarded as a *hoop-shaped girder*, the upper member being formed by the segment of the upper deck and its supporting beam, and the curved portion by the strip of the skin-plating and its stiffening rib. The fact that the skin and decks are continuous of course affects the resistance to change of transverse form; and the existence of longitudinal framing secures the joint and concurrent action of adjacent parts of the structure in that resistance. Considering for simplicity only one hoop-shaped girder, its power to resist changes in transverse form may be approximately estimated when the thicknesses of plating and planking are known, and the sizes of ribs and deck-beams are ascertained. Moreover, it will be seen that the power of resistance to change of form must be increased greatly when there are decks below the upper decks, the segments of which form approximately horizontal ties and struts to the hoop-shaped girder. Similarly, pillars reaching from the floors to the upper deck, and strongly secured to the floors and deck-beams, constitute vertical ties and struts. Or if there be longitudinal bulkheads, their segments play the same part as pillars.

Following out this general idea, it will be convenient to consider

the contributions to the transverse strength of the several parts of the structures above enumerated. The transverse frames or ribs in various classes of ships will be taken first, as these were the earliest, and are still the principal, means of giving transverse support to the skin.

In wood ships the ribs are made up of several lengths (or futtocks), bolted or dowelled at the butts, as shown in Fig. 128, p. 363, or connected together in some other way. Adjacent pieces in any one rib are comparatively free to bend inwards or outwards in relation to one another. No single rib has much strength to resist change of form. The shipbuilder, therefore, has recourse to the plan known as "shifting the butts" (see inside view Fig. 128), making adjacent ribs succour the butted rib, by having their butts at some distance from the weak joint. Formerly, transverse timbers (or "riders") were fitted inside the ribs to add to the transverse strength. When diagonal riders were used they also gave support to the ribs; but in later practice, when diagonal iron riders were employed, the ribs were left with little internal stiffening, except in the form of thick longitudinal planking and diagonal "trusses" from the bilges to the lower deck.

The ribs of iron, steel, and composite ships are ordinarily formed from the bilges upwards, by angle, Z, or channel bars of considerable length. In most merchant vessels each rib consists of a "frame" angle riveted to the skin, and a "reversed frame" riveted to the athwartship flange of the frame angle. The frame and reversed frame thus make up a Z-shaped section (see Fig. 129, p. 364, enlarged section of rib placed below the upper deck). Z-bars are now largely used for war-ships, and channel bars for merchant ships. Greater lightness is thus secured without reduction of strength, and labour is economized. Greater lengths of bars are also available, and the necessity for strapping or welding butts is avoided. The progress in the manufacture of iron and steel has thus greatly assisted shipbuilders in preparing the ribs and increasing their strength. From the remarks made on p. 354, it will be seen how important to the transverse strength of the typical hoop-shaped girder are the Z-form of the ribs, their depth, and the existence of the inner flange on the ribs. Turning to the enlarged section in Fig. 129, it will be obvious that the neutral axis must be very close to the skin; and that the inner flange, being most distant from that neutral axis, adds largely to the strength. Increase in the depths of the ribs also increases stiffness. This principle is now largely made use of in merchant ships in the form of "web-frames," or "partial bulkheads." *

* See in this connection a valuable paper "On the Transverse Strains of Iron Merchant Vessels," by Messrs.

Read and Jenkins, *Transactions of the Institution of Naval Architects for 1882.*

Below the bilges of iron, steel, and composite ships different modes of construction are followed. When there is no cellular double bottom, an arrangement like that in Fig. 129 is adopted. Deep floor-plates are fitted, gradually increasing in depth towards the keel. Reversed bars are riveted to the inner edges of the floor-plates, or these edges are flanged. The outer edges of the floor-plates are connected to the skin plating by frame-angles. Each rib is thus formed into a strong but light girder, capable of assisting in resistance to transverse strains.

In ships built with cellular double bottoms (like that illustrated by Fig. 131, p. 372), instead of the deep floor-plates, bracket-frames or lightened plate-frames stiffen and connect the inner and outer skins. It will be obvious that in such ships the inner skin contributes greatly to the transverse strength. A strip of that skin forms the inner flange of the hypothetical hoop-shaped girder, and the distribution of the material for resistance to transverse bending is much improved thereby. Care is required, of course, at the parts where the cellular bottom terminates, and ordinary transverse framing begins. The heels of the frames above the bilges are secured by brackets to the bounding longitudinals of the double bottom, and these, with other simple devices, are found sufficient in even the largest and swiftest steamships.

The cellular system of construction for war-ships, illustrated by Fig. 130, p. 369, differs in many respects from the arrangements common in ordinary merchant ships. In the larger cruisers and armoured vessels the transverse frames are spaced 4 feet apart in the double bottom, as against 2 to 2½ feet in merchant ships. These transverse frames are formed on the bracket system, and worked in short lengths between the longitudinals. Above the bilges where the inner bottom terminates, bracket-frames of considerable depth are fitted in the armoured ships, and connected with the frames behind armour, which are commonly spaced only 2 feet apart. The efficiency of the armoured target necessarily exercises great influence upon the framing and its connections, in many cases involving numerous breaks or discontinuities. By attention to details, however, it is found possible to meet all these conditions and yet to obtain ample transverse strength. The unarmoured portions of the upper works and of the extremities are usually supported by transverse frames formed of Z-bars.

In the smaller classes of cruisers, with protective decks and light plating on the cellular double bottoms, it has been preferred to have the transverse frames from 2 to 3 feet apart, in order to stiffen the bottom plating more efficiently. A common method is to have strong outer frame-bars extending in one length from the vertical

keel up to the protective deck. The longitudinals forming the side boundaries of the double bottom are pierced by these frame-bars, but made watertight around them. The longitudinals within the double bottom are "scored" over the frame-bars and connected to the outer bottom plating by short angles. The transverse framing in the double bottom is made up of bracket-plates between the longitudinals. In this manner construction is simplified and cheapened. Above the protective decks and outside the double bottom the transverse frames are usually formed of Z-bars.

In all war-ship construction, when cellular double bottoms are employed, the system of transverse framing is arranged so that adequate support may be given to the outer and inner skins for all ordinary conditions of service, while the two skins are so connected as to ensure their joint action in resisting the principal strains imposed upon the structure when ships are afloat. At the same time it is preferred not to give to the framing in the double bottom such strength or rigidity as would involve the transmission of heavy blows or shocks on the outer skin to the inner skin. Experience with many ships which have grounded proves that these intentions have been realized, especially in steel-built ships. Serious injuries to outer skins have bent and broken them, and the lower portions of the supporting frames, but have left the inner skin uninjured, and have preserved the buoyancy of the vessels sufficiently to enable them to reach port. The case of H.M.S. *Apollo*, mentioned on p. 336, is one of the most recent and striking illustrations of this feature in war-ship construction.

The spacing of transverse frames in vessels built on the longitudinal system advocated by the late Mr. Scott Russell was considerably greater than that in armoured ships, being from 12 to 20 feet in some cases. These transverse frames were made very deep and strong. They were formed of plates fitted in between the longitudinals, with stiffening angle-bars on the edges of the plates. Mr. Russell termed these strong frames "partial bulkheads"; and from these and the transverse bulkheads he obtained all the transverse stiffness required even in the *Great Eastern*, which had a cellular double bottom, and a cellular upper deck. In all such vessels the longitudinal frames were made strong and numerous, and upon them came the duty of distributing over intervening spaces, the strength of the bulkheads and partial bulkheads. The principal disadvantage of the system was the comparatively large areas of the outer skin—from 40 to 60 square feet—left without direct support. Hence it was decided, in adopting the bracket-frame system of framing for armoured ships, to lessen the frame-space to 4 feet, keeping the strong plate-frames at intervals of about 20 feet, and fitting

brackets at intermediate positions. The work of building was also facilitated by these departures from the original longitudinal system.

Deck-beams, planking, plating, and pillars greatly assist in preserving the transverse forms of ships. The first duty of the beams is to support the decks with their loads; this was the purpose for which beams were originally fitted. But the beams have other uses. As the various transverse strains previously described are brought to bear upon the structure, the tendency at one time may be to increase the distance between opposite sides of the ship, and at another instant to decrease it. In other words the beams have to act as ties and struts alternately between the opposite sides. Similarly, the pillars were first fitted as struts or supports to the beams, to assist in supporting the decks; but as the vessel rolls in a seaway, the strains tending to produce alteration of transverse form sometimes produce an increased thrust upon the pillars, and at others produce a pull or tension, if the pillars are well secured at both the heads and heels. Should the pillars be only capable of acting as struts, and not as ties, one important part of their possible usefulness is lacking, because they are powerless to resist any increase in the heights of the decks above the keel. Longitudinal bulkheads, such as the "wing-passage" bulkhead shown in Fig. 130, or the coal-bunker bulkheads usually fitted further inboard in war-ships, if well stiffened and connected at their upper edges to the decks, and at the lower edges to the outer or inner bottom, obviously exercise great influence in maintaining transverse form.

The beams of wood ships are ordinarily of wood, of rectangular cross-section, and formed of different pieces, joined together by more or less elaborate scarphs, some of which are illustrated in Figs. 137-141. The beam-ends very frequently rest upon a shelf-piece (see Fig. 128), which is bolted to the inside of the frame timbers, and are so secured to it (by dowels, etc.) as to be capable of withstanding a considerable force tending to pull the beam away from the side. Above the beam-end another strong longitudinal timber, the "water-way," is securely bolted to the timbers and strongly connected with the beam, greatly increasing the strength of its connection with the side. The beam is thus made capable of acting as a *tie* between the opposite sides. Its action as a *strut* is secured by accurately fitting its ends against the inside of the timbers. Thus far the arrangement is satisfactory, but it involves considerable skill and cost in scarphing the pieces that form the beam, and connecting the beam with the water-way, shelf-piece, etc. The rectangular form of cross-section is necessarily inferior to the flanged form; and this is an unavoidable defect with wood beams. These considerations led to

the extensive use of iron beams in the later wood ships of the Royal Navy; similar care being taken to make good the connection of the ends of these beams with the side, in order that they might act as struts or ties. Wood pillars also fell into disuse in wood ships, iron pillars of less weight being readily made more efficient as ties and no less efficient as struts.

Iron and steel ships have iron or steel beams of various sectional forms, all of which have more or less of that flanged form which has been shown to be so helpful to the association of strength with lightness. These beams can now be obtained from the makers in one length even for the largest ships, and so connected as to be capable of resisting both tension and compression. Their ends are very simply and strongly secured to the frames (see Figs. 129 and 130), the stringer plates on the beam-ends greatly strengthening the connection of the beams with the side. Tubular or flanged pillars can be associated with the beams, and made to resist both tension and compression. In every way, as regards strength and simplicity, the iron or steel ship has the advantage of the wood one in the character and connections of the beams and pillars. The composite ship in these particulars resembles the iron ship.

It has been explained above that deck-flats, whether formed by wood planking or iron or steel plating, assist the deck-beams greatly in the maintenance of transverse form. A completely plated deck, for example, if well stiffened by strong beams and bulkheads, is practically rigid when subjected to strains tending to alter the transverse form. If a ship has a series of such decks, the transverse frames or ribs really have little more to do than to stiffen the sides between the strong decks, or between the lowest of these decks and the bilges. In merchant ships of large size two or three completely plated decks are now common, and they are of the greatest value in the maintenance of the transverse form as well as in resisting longitudinal bending. This twofold usefulness has been previously mentioned, and it is as applicable to the skins as to the decks of ships. In armoured ships strongly plated "protective" decks are now the rule; and these decks contribute greatly to the transverse strength, being assisted by other plated decks which are built for structural purposes only. Protective decks are also common in war-ships which have no side armour, and although fitted primarily for protection to machinery, magazines, etc., they are valuable additions to the transverse strength. In many cases the transverse framing of war-ships is worked in separate lengths above and below protective decks, or behind armour. With proper connections no difficulty is experienced in the maintenance of strength.

The lower decks of ships often extend over only a portion of the

length, or are considerably weakened by having large openings cut in them. Merchant ships frequently have no lower decks in wake of the cargo holds, and consequently there is not nearly the same strength of connection between opposite sides at those parts as would be secured by a strong deck with its beams. To compensate in part for this loss of strength, it was formerly the practice to fit a few strong beams—known as hold-beams—in the cargo-spaces. In very many cases where such precautions were not taken, serious working and change in transverse form resulted. Instead of hold-beams, deep plate-frames or partial bulkheads are now commonly fitted as previously explained.

Perhaps the greatest point of difference between the action of the beams in wood and iron ships is to be found in their comparative resistances to *change of the angles* between the decks and the sides of the ship. The strains tending to produce such changes have been previously described; and their effects on wood ships were so serious as to cause shipbuilders to bestow great attention upon beam-knees and their connections. A vast number of plans for beam-knees were proposed. Formerly, before iron strengthenings became general, cumbrous timber knees were fitted; and in countries where timber is abundant such knees are even yet employed. Forged iron knees are, however, now much more generally employed, and are more efficient than timber knees, as well as less bulky. But even with the best of these arrangements—such as the knees shown under each beam-end in Fig. 128—heavy rolling in a seaway produced sensible changes of angle. The usual indications of these changes were loosening of the fastenings which secured the iron knee to the side and to the beam-end; and in the larger classes of wood frigates and line-of-battle ships in the Royal Navy these indications were not uncommon.

The reasons for the superior resistance of iron and steel ships to any corresponding change will be obvious on comparing Fig. 128 with Figs. 129 and 130. The beam-ends of the iron and steel ships are shaped into strong knees, far more capable, from their form, of preventing change of angle. These stronger knees are fitted against the sides of the frames, and strongly riveted to them: the frames themselves are riveted to the skin, and in very many cases the stringer plates on the beam-ends are also directly connected with the skin, so that the beam-end cannot change its angle relatively to the side of the ship without shearing off numerous rivets, or fracturing plates and angle-bars. With properly proportioned knees and riveting, change in the angle made by the decks of iron and steel ships with the sides may be almost entirely prevented. Imperfect fastenings in the beam-knees may permit, and in some

cases have permitted, working at the junction of the decks and sides even in these ships; especially when they have happened to be associated with a considerable amount of flexibility in the frames to which the beams are attached. But these cases can only be regarded as examples of a defective application of principles which, when properly applied, lead to satisfactory results.

Similar knees are formed on iron beams fitted to wood ships. Instead of attaching the beam-arm directly to an iron frame, as can be done either in an iron or composite ship, it has then to be secured to the side by means of angle-bars riveted through the beam, and bolted to the side planking and timbers. This plan is more efficient in preventing change of angle than ordinary knees fitted to wood beams, but is not so efficient as that of iron and composite ships, the connection with the side not being so perfect.

Sometimes deep plate-knees are fitted below some of the beams in iron and steel ships, reaching from one deck to that next below it, for the purpose of stiffening the side. The beams forming the boundaries of large cargo-hatches or boiler-hatches in some merchant ships are treated in this manner, and made deeper and stronger than the other beams, for the purpose of compensating for the loss of transverse strength produced by cutting off the beams to form the openings in the deck. The growing use of partial bulkheads in the holds of merchant ships has been mentioned above: at the stations where they occur deeper beams are fitted, as shown (by dotted lines) in Fig. 131. In iron and steel-built ships of the Navy also, "partial bulkheads" are frequently fitted at intervals between the main and upper decks, in order to stiffen the sides and to assist the beam-knees in preventing change of angle. Each of these partial bulkheads is very simply formed by a plate 3 or 4 feet wide, connected at its upper end to the beams or stringer plate of the upper deck, at its lower end to the stringer plate on the main deck, and also attached to the side plating.

Not unfrequently it is a convenience to be able to dispense with knees to lower deck beams; a case in point is illustrated by Fig. 30, p. 36. If the ship has a sufficient number of transverse bulkheads, this disuse of beam-knees is no source of weakness. Moreover, it will be remembered that the transverse racking strains described in a previous chapter are likely to be more severe on the upper and main decks than on the lower decks. These racking strains chiefly cause the alterations of angle between the decks and sides, as well as deformations at or near the bilges; but it is especially at the upper parts of the structures of ships that their effects require to be provided against by strong beam-knees and partial bulkheads.

Transverse bulkheads, when properly constructed, add greatly to

the transverse strength of all ships, but are most valuable in iron or steel ships having the main frames placed longitudinally and the transverse frames widely spaced. The cross-sections at which such bulkheads are placed may be regarded as practically unchangeable in form, under the action of the severest transverse strains experienced by a ship, provided the thin plating which forms the partition be efficiently supported by angle-bars, T-bars, Z-bars, or other forms of "stiffeners" riveted to its surface. A good arrangement of the stiffeners is that which places one set vertical and the other horizontal, the plating being thus prevented from buckling in any direction. The decks and platforms which meet the bulkheads lend very material help by stiffening them and thereby preventing change of form. When longitudinal bulkheads are associated with transverse bulkheads the two systems afford mutual support. Having thus secured great local transverse strength, it becomes necessary to provide the means of distributing it over the spaces lying between any two bulkheads; this end is best accomplished by means of strong longitudinal frames, which are carried from bulkhead to bulkhead, and rest upon them just as the girders of a bridge rest upon the piers. The efficiency of the transverse bulkheads as stiffeners to the structure depends upon their strength and numbers, the distance between consecutive bulkheads, and the capability of the longitudinal framing to distribute the strength of the bulkheads. Ordinary iron or steel ships, having comparatively few bulkheads, do not gain so much from their help as ships with bulkheads spaced more closely. The desire to have large cargo-spaces in the hold, free from break or interruption, overrides, in many cases, considerations of increased safety and greater strength. At intervals between complete transverse bulkheads, "partial" bulkheads, formed by deep plate-frames with angle-bars on both inner and outer edges, are now commonly fitted. But there are considerable spaces in the length of ordinary merchant ships for which the transverse frames have to furnish the principal part of the transverse strength to the lower part of the structure, and the fewness of the bulkheads is one reason for retaining the close spacing of these frames.

Supposing a large number of transverse bulkheads to be fitted in an iron or steel ship, the distribution of their strength over the bottom mainly depends upon the longitudinal stiffeners—keelsons, hold stringers, etc. These include very various arrangements, of very various degrees of efficiency; but in none is the distribution so simply and efficiently made as in vessels where the main frames are longitudinal. Longitudinal bulkheads, when they are fitted either at the middle line or towards the sides (or wings), largely assist in the distribution of the strength of transverse bulkheads. In short,

all the pieces lying longitudinally, which are efficient against longitudinal bending strains as well as against some local strains, are also valuable distributors of transverse strength.

Composite ships are often fitted with transverse iron or steel bulkheads, the vessels of that class belonging to the Royal Navy being exceptionally well subdivided. These bulkheads contribute much transverse strength, which is distributed very similarly to that for ordinary iron or steel ships, except that the longitudinal pieces are not so well connected to the skin. Closely spaced transverse frames are trusted, however, to supply the chief part of the transverse strength.

Wood ships of the later types in the Royal Navy, and in some foreign navies, have been furnished with transverse iron bulkheads, and the results have been very satisfactory; but there was greater difficulty in making the bulkheads succour parts lying between them in wood ships than there is in iron or steel ships; and the attachment of the bulkheads to the sides was not so efficient as it is in either iron or composite ships.

CHAPTER X.

MATERIALS FOR SHIPBUILDING : WOOD, IRON, AND STEEL.

THREE classes of materials have been extensively used in shipbuilding. From time immemorial *wood* ships have been constructed, and that material was exclusively employed for seagoing ships until the year 1838. *Iron* had been used for building canal boats half a century before; and from 1821 had been employed in steamers built for river service, some of which made over-sea voyages to the places where they were regularly engaged. In the British mercantile marine from 1840 onwards iron steadily gained on wood; at first by slow degrees, but subsequently very rapidly. In 1850, out of 133,700 tons of new shipping added to the British Register only 12,800 tons were iron ships; in 1860, out of 212,000 tons added 64,700 tons were iron; in 1868, out of 369,000 tons added 208,000 tons were iron; in 1880, out of 404,000 tons added 384,000 tons were iron; in 1891, out of 670,000 tons added less than 9000 tons were of wood. In fact, except for small vessels, wood shipbuilding has practically disappeared.

The progress of iron-shipbuilding has been concurrent with the development of steam navigation, and was essential to that development. In 1850, out of 275,000 tons of British mercantile steamers on the Register, 218,000 tons were of wood. In 1860, out of 686,000 tons of steam shipping, 536,000 tons were of iron. In 1868, out of 1,341,000 tons, wood ships represented only 122,000 tons, and iron over 1,200,000 tons. The building of wood seagoing steamers has practically ceased for many years past; and in 1891 the total (nett) tonnage of wood steamships built was less than 600 tons.

The Royal Navy presents a similar picture. In 1850 the tonnage (B.O.M.) of wood ships had a total of 99,000 tons, against 19,500 tons for iron ships. In 1860 the proportion of wood to iron was even greater than at the earlier date, 420,000 tons against 34,800 tons. But with the construction of armoured ships iron hulls became general; and in 1870 the total tonnage of wood ships had fallen to 386,000 tons, while that of iron ships had nearly quadrupled since 1860, becoming 130,200 tons. No wood-hulled

fighting ship was laid down for the Royal Navy after 1873, and the last examples were of comparatively small size. All the armoured ships begun after 1866 have iron or steel hulls; and so have other classes, except sloops and gunboats, most of which have been built on the composite principle, with wood skins, but iron or steel framing.

In other countries, where shipbuilding timber is plentiful and cheap, wood ships are still constructed of considerable size and in large numbers. These are principally sailing ships. The inevitable tendency in all such cases is, however, towards the substitution of iron or steel hulls for wood, because of the commercial advantages thereby obtained.

Having driven wood from its pre-eminence as a shipbuilding material, iron, in its turn, has given place to steel. Prior to 1870 steel was used to a very limited extent, and chiefly in cases where extreme lightness of hull or shallowness of draught were essential. Taking the twenty years from 1850 to 1870, over 3,600,000 tons of iron ships were built for the British mercantile marine, while only 27,000 tons of steel ships were constructed; and from 1866 to 1875 only three small ships were built of steel in the United Kingdom. In the Royal Navy steel was used continuously from 1864 to 1875 for certain portions of the internal framing of iron ships and armoured vessels, but always under special precautions. Early in 1873 the French began to use so-called "mild steel," or "ingot-iron," in the construction of war-ships. The Admiralty followed this example in 1875, ordering two despatch vessels to be constructed wholly of steel; and in 1877 the use of the same material in the mercantile marine received the sanction of Lloyd's Register. Since 1875 the progress made in the use of mild steel has been extremely rapid. In the Royal Navy it has entirely superseded iron, and the experience gained with the new material has fully justified the change. In the mercantile marine slower progress was made at first, but there has been a very general adoption of steel in later years. In 1878 only 4500 tons of steel shipping were classed at Lloyd's; in 1879, 16,000 tons; in 1880, 35,400 tons; and in 1881, 41,400 tons. In the latter year the total tonnage of steel ships was less than 6 per cent. of the aggregate tonnage of iron and steel ships. Four years later (1885) this had become nearly 35 per cent.; in 1887 it exceeded 80 per cent.; in 1889, 94 per cent.; and in 1892 was nearly 98 per cent. The amount of iron shipbuilding remaining is distributed over a number of vessels of very moderate size. Iron shipbuilding is, therefore, virtually extinct in this country, except for small vessels.

Besides wood, iron, and steel, other materials have been used in the construction of small vessels. Certain bronzes, for example,

have been employed in experimental torpedo boats and steamboats. Aluminium has been used in a few cases for the hulls of yachts and steamboats. In these exceptional cases it has been desired to demonstrate the capabilities of the materials employed, especially in regard to their freedom from corrosion such as iron and steel ships undergo unless proper care is taken. Aluminium has been used, not merely for this purpose, but also because of its remarkable association of strength with lightness, as compared with iron or steel. Whatever developments may be made in future in any of these directions, or in the use of alloys of nickel and other metals with steel, it is only necessary in this work to consider these three materials that have been largely used in the past. Although wood and iron are now practically obsolete, it will be interesting to examine briefly into their qualities as shipbuilding materials. By so doing it will be seen why iron was preferred to wood, and subsequently had to give place to steel. Moreover, this discussion will enable many important features in ship-construction not treated elsewhere in this volume, to be touched upon and illustrated.

The structure of a ship is necessarily made up of many pieces, and the strength of the structure depends upon their individual strength, as well as their skilful combination. In considering the capabilities of any material, it is therefore necessary to examine into the behaviour of *individual pieces* when subjected to tensile, compressive, bending, or torsional strains; and also to investigate the behaviour of *combinations of pieces* under similar strains. Of these strains torsional are of much less importance than the others, with the exception of a few pieces, such as the rudder-head. Tensile and compressive strains, as has been explained in previous chapters, are of the first importance; bending strains are also of importance in relation to many parts of the structure, such as the deck-beams, transverse and longitudinal framing, and unsupported areas of the skin plating subjected to water pressure.

Relative Strengths and Weights of Single Pieces of Wood, Iron, and Steel.—It will be convenient to consider first the resistances of *single pieces* of wood, iron, and steel to tensile and compressive strains. Take a simple tie-bar, for example, and suppose it fixed at one end, while a tensile force is applied at the other. As the force is gradually increased the bar will begin to stretch, and up to a certain point the elongations will be directly proportional to the stresses. After this point is passed increase in stress is accompanied by rapidly increasing extensions. Finally, a certain amount of stress produces rupture. This determines the *ultimate strength* of the bar. The upper limits within which extensions are proportional to stresses are usually termed the "limits of elasticity," or shortly "elastic limits." For

different materials the ratios of the ultimate to the elastic stress vary considerably. Formerly it was the practice to fix the elastic limits by the further consideration that within them, if the stresses were removed, the bar should return to its original length, and that there should be no "permanent set" or elongation. It is now known, by the use of improved measuring appliances, that "permanent sets" of very small amounts do occur for values of the stress much below the elastic limit as above defined. In practice the tensile stress brought upon a tie-bar of iron or steel and frequently repeated is rarely allowed to exceed one-half or one-third of the elastic stress. Consequently, sensible permanent set is avoided, as it clearly ought to be if the strength is to be maintained. Let the bar, for example, be L feet long, and let it be observed to stretch $L \div n$ (feet) under a stress of P lbs. per square inch of the sectional area of the bar: then for any other stress Q we must have—

$$\text{Elongation} = \frac{Q}{P} \times \frac{L}{n}$$

If it were possible, without passing the limits of elasticity, to *double* the length of the bar, and E were the stress which would produce this elongation, we must have—

$$L = \frac{E}{P} \times \frac{L}{n}; \text{ whence } E = Pn.$$

This is confessedly a hypothetical case, since no bar could be stretched to double its length without exceeding the limits of elasticity; but the hypothesis can be advantageously used in practice. The quantity E is termed the *modulus of elasticity*, and its comparison for various substances furnishes a ready means of estimating their relative efficiencies in resisting change of form. Within certain limits this mode of comparison is applicable to compression as well as extension. To illustrate this formula two examples may be taken. A piece of English oak was found to stretch $\frac{1}{1152}$ part of its length under a load of 1680 lbs. per square inch. For it—

$$\text{Modulus of elasticity} = 1152 \times 1680 = 1,935,000 \text{ (nearly).}$$

A steel plate was found to stretch $\frac{1}{10,000}$ part of its length under a load of 32,000 lbs. per square inch. For it—

$$\text{Modulus of elasticity} = \frac{10,000}{11} \times 32,000 = 29,091,000 \text{ (nearly).}$$

With specimens of timber considerable difficulties arise in determining fair average values for the moduli of elasticity and for the ultimate tensile and compressive strengths. Even when the utmost care has been taken to season timbers, considerable variations are

found to exist, not merely in different logs of the same description of timber, but in the strengths of different pieces cut from various parts of the same tree. Such causes as the existence of knots, cross-grain, etc., affect the strength, and it is very different lengthwise of the grain from what it is across the grain. This fact explains the diverse results obtained by various experimentalists. From the best results available the following table has been compiled for a few of the timbers most commonly used in shipbuilding:—*

Timbers.	Average weight per cubic foot.	Tensile strength.	Compressive strength.	Modulus of elasticity, Rankine's values.
	Pounds.	Pounds per sq. in.	Pounds per sq. in.	
British oak . . .	54	7,600 to 10,000	7,600 to 10,000	1,450,000
Dantzic oak . . .	52	4,200 to 12,800†	6,800 to 8,700	1,190,000
Dantzic fir . . .	36	2,240 to 4,480	7,000 to 9,500	1,958,000
English elm . . .	35	5,500 to 13,500†	5,800 to 10,000	700,000
Pitch pine . . .	40	4,600 to 7,800	6,500 to 9,800	1,228,000
Teak . . .	48	3,300 to 15,000†	6,300 to 12,000	2,400,000
African oak . . .	62	4,800 to 10,900	10,000 to 11,000	—
Sabicu . . .	57	4,300 to 6,900	6,500 to 9,000	—

As an illustration of the difficulties just mentioned, it may be stated that more recent experiments than those used by Rankine, conducted with great care in the Royal Dockyards, gave a modulus of elasticity of 1,300,000 only for teak, and of about 1,900,000 for English and Dantzic oak. The average modulus proposed by Rankine for the more important shipbuilding timbers when acting in association with iron or steel was 1,750,000, and this may fairly be accepted. A fair average value of the compressive strength of these timbers is probably about 3 to 3½ tons per square inch; and their average weight is about 48 lbs. per cubic foot. Professor Rankine proposed to take about 5½ tons as the average ultimate tensile strength of shipbuilding timbers. More recent experiments would indicate that this is too high an estimate, and that a fairer one would be about 3 tons per square inch.

Good iron, such as was formerly used in the hulls of her

* These figures are based upon the experiments of Barlow, Tredgold, Hodgkinson, and others, of which an excellent summary is contained in the late Professor Rankine's work, "Shipbuilding, Theoretical and Practical," as well as upon the more recent and valuable experiments recorded in "Timber and

Timber Trees," by Mr. Laslett, late Admiralty Inspector of Timber. Sir W. Fairbairn's tables have also been examined in comparison with the others.

† Doubtful values; Mr. Laslett gives 5700 lbs. as the upper limit for teak, 7400 lbs. for Dantzic oak, and 6700 lbs. for elm.

Majesty's ships, had an ultimate tensile strength of from 18 to 22 tons per square inch. Samples cut lengthwise from plates showed about 16 to 20 per cent. greater tensile strength and considerably greater ductility than samples cut crosswise from the same plates. All this iron was subjected to systematic testing before being used. In the mercantile marine similar tensile and bending tests were not commonly made on the iron used. The "brand" of the maker was usually accepted as evidence of good quality, supplemented, of course, by the practical tests involved in working the material into ships. Considerable variations occurred under this system in both strength and ductility; but it was understood that good iron should have an ultimate tensile strength of about 20 tons per square inch in samples cut lengthwise from plates or bars. The weight of iron per cubic foot is about 480 lbs. Rankine gave 28,000,000 as the modulus of elasticity for good wrought iron; possibly this is a somewhat high estimate. Ductility, as measured by the ultimate extension before rupture took place, varied greatly. In good specimens of iron having an ultimate tensile strength of about 21 tons per square inch, Mr. Kirkaldy found the mean ultimate extension in a length of 10 inches to be about 9.6 per cent. for lengthwise samples, and about 3.2 per cent. for crosswise samples. The elastic limit of good wrought iron appears to lie at from 50 to 60 per cent. of the ultimate tensile strength.

Authorities differ widely as to the ultimate resistance to compression of wrought iron. Rankine fixed it at from 27,000 to 36,000 lbs. per square inch; and Fairbairn (on the authority of Rondelet) at 70,000 lbs. Experiments on short cylinders, having lengths varying from $1\frac{1}{2}$ to 2 diameters, made by Kirkaldy, showed the "elastic stress" to vary from 31,000 to 33,400 lbs. per square inch. These experiments were carried on to pressures of 100,000 lbs. per square inch, when the cylinders became "barrel-shaped," and were depressed over 40 per cent. of their length. At 50,000 lbs. per square inch the corresponding depressions were from $2\frac{1}{2}$ to 4 per cent. only.* This shows that for practical purposes, supposing "buckling" to be prevented, wrought iron under compression can offer at least as great a resistance as to tension before sensible "break-down" occurs. In the comparatively thin plating of the skin or decks failure by "buckling" under compression, rather than crushing under direct thrust, has to be guarded against by suitable stiffeners.

Steel of the "mild" quality now used in shipbuilding is a

* These experiments were made on behalf of Mr. Wigham Richardson, who communicated the results to the North of England Institute of Mining and Mechanical Engineers in December, 1883.

material which is in many respects superior, and in no respect inferior to iron. It can equally well withstand all the operations of the shipyard; is very ductile and malleable; about 25 to 30 per cent. stronger, under tensile strain, than the best iron ship-plates; and only 2 to 2½ per cent. heavier for equal volumes. Most of the varieties of steel used in shipbuilding before 1873 had the serious disadvantage of lacking uniformity in strength, ductility, and malleability. If these serious faults were avoided by exceptional care in manufacture, the price of the material became so high as to be practically prohibitive except in very special cases. Not unfrequently steel plates made under practically similar conditions, and presumably of the same quality, displayed, when tested, singular differences in their qualities. Consequently the shipbuilder and shipowner had not the same assurance of safety with steel as was possible with iron. Moreover, it was found with these earlier descriptions of steel that much greater care was required in the manipulation during the various processes of building—such as punching, bending, forging, and riveting—than was needed in the corresponding operations on iron. These steels were much stronger than iron, having tensile strengths from 30 to 50 tons per square inch, as against 18 to 22 tons for good iron. On account of their greater strength these varieties of steel were used in exceptional cases, notwithstanding their known faults and greater cost. Vessels for river service like that illustrated in Figs. 132 and 133, p. 379, steamers for the Channel service, blockade-runners, and other classes in which lightness of hull was the most important condition to be fulfilled, were all built of steel. Most of these early steel ships performed their work well, and some of them displayed remarkable durability under very trying conditions of service. The failures and difficulties to which allusion has been made were chiefly experienced in the shipyard.

Mild steel is practically free from the defects mentioned above. It can be produced in large quantities, of uniform quality, and at a cost which does not compare unfavourably with that of good wrought iron. The tensile strength of the material now in common use is not so high as that of earlier varieties of steel, but the ductility is much greater. From 26 to 32 tons per square inch represent the limits of tensile strength not commonly exceeded; the elongation of a sample before fracture under tensile strain frequently reaches 25 to 30 per cent. in a length of 8 inches. But there is reason to believe that still higher tensile strength, up to 35 or 40 tons per square inch, may be obtained, if desired, in association with excellent working qualities, and without that degree of hardness which would make the steel take a "temper" when heated to a low cherry-red and plunged into water having a temperature of about 80° Fahr.

Another property of mild steel deserving notice is the practical equality of the strength and ductility of samples cut lengthwise or breadthwise from plates. With iron, as above stated, the samples cut lengthwise would have about one-fifth or one-sixth greater tensile strength and much more ductility than the crosswise samples from the same plate; and care has to be taken in many parts of iron ships to adjust the plates and butt-straps in the manner most favourable to this inequality of strength. Closely connected with this uniformity of strength and great ductility is the capacity of mild steel to bear rough usage. Under percussive strains—produced by the blows of steam-hammers, falling weights, the explosion of gun-cotton, etc.—mild steel has been proved greatly superior to the best wrought iron. In cases of collision, grounding, etc., ships built of mild steel have had their plating bulged and bent without cracking under circumstances which would have broken through less ductile iron plates. In the shipyard much work can be done on steel cold, which could only be done on iron after heating. One most important feature in the working qualities of mild steel should be mentioned. It should not be subjected to percussive strains or shocks when at a “blue-heat”—say from 430° to 580° Fahr., at which heat its ductility is at a minimum.

The “elastic limit” for mild steel has been found to vary from about 55 to nearly 80 per cent. of the ultimate strength, and 60 per cent. is probably a fair average value. For superior qualities of iron, about the same percentage of the ultimate strength probably represents the elastic limit. Hence it follows that, notwithstanding its greater ductility, mild steel can bear “working strains” having as great a ratio to the ultimate strength as superior wrought iron can bear. This is an important matter: mild steel may be trusted with working tensile stresses from 25 to 30 per cent. greater than superior iron.

Under compression mild steel also gains as compared with iron although perhaps to a less extent than under tension. Experiments made with short cylinders of steel, similar to those described for wrought iron, showed the elastic stress to vary from 34,300 to 36,000 lbs. per square inch, or a gain of about 10 per cent. as compared with iron. Under loads of 50,000 lbs. per square inch, the steel cylinders sustained depressions practically as great as those sustained by the iron cylinders. As above remarked, these experiments do not represent the conditions of practice, where compressive strains, if they cause failure in portions of a ship's structure, usually do so by buckling. In steel ships, where plating is thinner than with iron, there is a greater necessity for carefully arranging the stiffeners and supports of plating in order to prevent buckling.

The modulus of elasticity for mild steel, determined from a large number of experiments, is about 29,500,000, or about $5\frac{1}{2}$ per cent. above that given by Rankine for wrought iron.

An important factor in relation to the use of steel in the mercantile marine is the introduction of systematic tests for all the material used. In this way strength and uniformity are guaranteed; whereas with iron, as explained above, no corresponding tests were made in building merchant ships. In the Royal Navy, where systematic tests of iron have always been the rule, only a few changes in the test conditions have been necessary for steel.

A simple comparison may now be made between single pieces of wood and iron when subjected to tensile or compressive strains. Take British oak as a standard timber. Its weight per cubic foot is given in the table as 54 lbs., or say *one-ninth* that of iron; the mean ultimate strengths there given are about 4 tons per square inch or about *one-fifth* that of iron. Here, then, the timber apparently gains upon iron in ultimate strength for a given weight. Under the conditions of practice, however, it is less favourably situated. The builder could have no certainty that any piece of oak would reach the tabulated average strength. Some specimens of oak tested have had only *one-eighth* the ultimate strength of iron. Again, in practice it is not ultimate strength which must be considered, but that limit of force that may be safely repeated many times without distressing the material. This may be described as the elastic or working strength; and with timber there is a very different range of elasticity from that obtaining in iron. With the latter material the working strength may be taken as about *one-fifth* of the ultimate strength; in other words, a "factor of safety" of 5 is sufficient. With timber experience points to the desirability of using factors of safety nearly twice as great—8 to 10. Under tension a factor of safety of 10 is not excessive, giving about *four-tenths* of a ton per square inch of sectional area as the working limit for oak. For iron the corresponding limit would be about 4 tons per square inch, or *ten times* as great, while the weight is only *nine times* as great for equal sectional areas of iron and wood. Hence it is seen that iron has the advantage in the ratio of strength to weight, under the conditions of practice. Steel would have a still greater advantage.

Under compression a factor of safety of 8 might be accepted; the working load for the oak would then be about *half a ton* per square inch. For wrought iron the corresponding load would be about *three tons*. Here the oak would gain on the iron if the single struts considered were similar in cross-sectional forms—say solid rectangles or circles such as timber struts must be. Iron or steel struts, however, may be made with hollow or "flanged" cross-sections, and in this

way have their assistance to compression greatly increased, so gaining upon wood struts of equal weight and length. It will be noted, moreover, that pieces in the structure of a ship have to bear at various times both tensile and compressive strains; while in practice the tensile strains are usually most severe.

A brief reference will suffice to the relative capabilities of wood, iron, and steel when subjected to *bending* moments. The condition of a bent beam has been described at p. 351. Failure, when it occurs in such a beam, usually begins either at the upper or lower surfaces most distant from the neutral axis. The bounding layers of the material are subjected to excessive tensile or compressive strains and give way. There is no doubt that in solid wood beams of rectangular cross-section the intimate connection of the parts with one another influences the ultimate resistances of the material in the bounding layers under bending moments, as compared with the ultimate tensile or compressive strengths of the same material. This influence may be marked, as in the following cases given by Rankine:—

Timbers.	Strength in pounds per square inch.		
	Tensile.	Compressive.	Cross breaking.
Dantzic oak	12,780	7,720	8,740
Jamaica mahogany	—	8,800	16,600
Pitch pine	7,800	—	9,800

Such considerable differences are, however, the exceptions rather than the rule, and do not appear in the timbers most used. For practical purposes, therefore, in solid timber beams as well as in flanged iron or steel beams, the ultimate resistances to bending strains of the material in the bounding layers may be taken as fairly approximating to the ultimate resistances to tension and compression above described.

The advantages obtainable with *flanged forms* of beams, as compared with beams of rectangular cross-section, have also been illustrated at p. 354. In their capacity to be manufactured or built up into such flanged forms, iron and steel gain greatly upon wood. Steel also gains upon iron, because its greater ductility and its homogeneous character permit it to assume, in the process of manufacture, sectional forms which were either impossible or most difficult and costly to produce in iron. These remarks apply not merely to deck beams, but to frames, stiffening bars, pillars, and many other parts of the structures of ships which are subjected to

bending strains. Instead of solid masses of timber, flanged forms of iron or steel will give the necessary strength with less weight.

Fig. 134 contains a few examples of the great varieties of

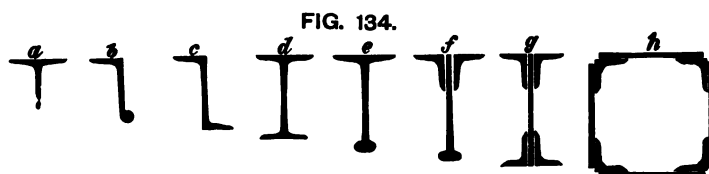

a, T-bar.
b, angle-bulb.
c, Z-bar.
d, H-bar.

References.

e, T-bulb.
f, bulb-plate with angle-bars.
g, made beam.
h, box beam.

sectional forms in iron and steel which the manufacturer places at the service of the shipbuilder.

The simple angle-bar is sometimes used as a beam; its form may be seen from the sections *f*, *g*, *h*, in Fig. 134, and differs from the T-bar in having a top flange on one side only of the vertical web. Neither the angle nor the T form is well adapted for resisting bending strains, because of the absence of a bottom flange. The angle-bulb (*b*) is a great improvement in this respect, and is used for light decks or platforms as well as under completely plated decks. Z-bar (*c*) is used for frames behind armour for transverse framing, and for longitudinal stiffeners, but not often for beams. Channel-bars, differing from Z-bars in having both flanges on one side of the web, are now largely used instead of Z-bars. H-bar (*d*) is expensive, and is not used so much as the made beam (*g*) of similar cross-section. Not unfrequently, instead of having double angle-bars on the upper edge of the made beams, to a deck covered with iron or steel plating, only single angle-bars are worked, a portion of the deck plating above the beam then forming the upper flange. Sections *e* and *f* may be regarded as interchangeable; the latter was formerly much in use, but since manufacturers have been able to produce the section *e* with ease and at moderate cost, the shipbuilder naturally prefers to obtain the finished form. The box-beam *h* is only used where exceptional strength is required, to support some concentrated load, or to furnish a very strong tie. Of the other sections sometimes used it is needless to speak; they all, or nearly all, exhibit the general characteristic of top and bottom flanges, or bulbs connected by a thin vertical web. Even for the largest ships, beams of these sections are now procurable in one length, which is another great advantage as compared with the two-piece or three-piece wood beams required in large ships.

A comparison may be made between the weights and "working strengths" of wood and iron beams, in order to illustrate the preceding general statement. For this purpose the following figures will suffice, although they do not pretend to exactness. Taking 20 tons as the ultimate tensile strength of the iron, and a "factor of safety" of 5, the working strength will be 4 tons per square inch. Then for a flanged iron beam such as is ordinarily used we may assume—

$$\left. \begin{array}{l} \text{Safe bending moment (working} \\ \text{strength of beam)} \end{array} \right\} = 4 \text{ tons} \times \text{sectional area} \times \frac{\text{depth}}{3}$$

The sectional area being expressed in *square inches*, and the depth in *inches*, the bending moment will be expressed in *inch-tons*; that is to say, by the product of a load in tons into a leverage in inches. For example, take a beam of section *d*, Fig. 134, 12 inches deep, with top and bottom flanges, each 6 inches wide, and web and flanges $\frac{1}{2}$ inch thick.

$$\text{Sectional area} = (12 + 6 + 6)\frac{1}{2} = 12 \text{ sq. in.}$$

$$\text{Safe bending moment} = 4 \text{ tons} \times 12 \text{ sq. in.} \times \frac{12}{3} = 192 \text{ inch-tons.}$$

Since iron weighs about 480 lbs. per cubic foot, this beam would weigh about 40 lbs. for each foot of length.

A teak beam of rectangular section weighing 40 lbs. per foot of length, may be assumed to have a sectional area of about 120 square inches. If 12 inches deep like the iron beam, it would be 10 inches broad. Take the working strength (as on p. 403) at *four-tenths* of a ton per square inch, a factor of safety of 10 being employed with an ultimate tensile strength of 4 tons. Then for the rectangular form of beam—

$$\begin{aligned} \text{Safe bending moment} &= .4 \text{ ton} \times \text{sectional area} \times \frac{\text{depth}}{6} \\ &= .4 \times 120 \times 12 \times \frac{1}{6} = 96 \text{ inch-tons.} \end{aligned}$$

That is to say, with *equal weights* the teak beam could be trusted only with *one-half* the bending moment which the iron beam could bear. A steel beam would be still stronger in relation to its weight.

Supposing the problem differently stated. What would be the dimensions and relative weight of an oak beam capable of sustaining the same bending moment as the iron beam in the preceding illustration. Let the oak beam be supposed of a *square* section, its depth and breadth being *x* inches. Then, as before—

$$\text{Bending moment} = 4 \text{ tons} \times x^2 \times \frac{1}{6}x = 192 \text{ inch-tons}$$

$$x^3 = 2880$$

$$x = 14\frac{1}{4} \text{ inches (roughly)}$$

$$\text{Sectional area} = 202 \text{ sq. in.} = 1.4 \text{ sq. ft.}$$

$$\text{Weight per foot length} = 1.4 \text{ sq. ft.} \times 54 \text{ lbs.} = 75.6 \text{ lbs.}$$

Each foot of length of the oak beam would therefore weigh about 90 per cent. more than each foot of the iron beam, although capable of bearing only the same load.

Relative Strengths of Combinations of Wood, Iron, and Steel.—Passing from single pieces subjected to tension or compression, to the conditions of practice where such pieces have to be combined and to act together, the advantages of iron and steel over wood become more apparent. Under compression a combination of pieces of timber is most favourably situated. This has already been explained (at p. 365) when illustrating the resistance to hogging strains offered by the lower parts of wood ships. Two planks or timbers, with a plain “butt” joint, or flat end to each, will effectively transmit a thrust, provided only that the two ends are well fitted to one another, and are prevented from changing their relative positions.

On the contrary, when several pieces of timber have to be combined in order to resist *tensile* strains, their resistance compares much less favourably with that of a combination of iron plates or bars than does the ultimate tensile strength of a single piece of timber with that of a single piece of iron. Against tension a butt-joint is obviously quite ineffective. In Fig. 128, p. 363, if any two timbers abutting on one another in a rib or frame were considered to act alone, and to be subjected to a strain tending to separate the butts, they could oppose no resistance except the friction of the dowel, which would be very trifling. If a “strap” of wood or iron were fitted over the butts and bolted to the timbers, it would resist the force tending to open the butts; and it has been shown that the weakness of the butts in any rib is, so to speak, covered by the strength of the unbutted ribs lying on either side. In many wood ships the timbers of consecutive ribs were bolted together, in pairs, to increase the strength of the frame. In the case of the water-way fitted upon the beam ends of a wood ship (Fig. 128) the various pieces were plain-butted; but the butts were covered by strong carlings fitted underneath, and to these the water-way pieces were dowelled. This was an exceptional arrangement, however, the almost universal plan adopted where two pieces of timber had to be joined end-to-end, in order to form a tie, being to “scarph” or overlap the ends in some fashion more or less complicated and expensive.

Take the keel, for example, in a wood ship; the adjoining pieces were secured by what is termed a "tabled scarph." Fig. 135 shows the two parts of the scarph thrown back to exhibit the projecting

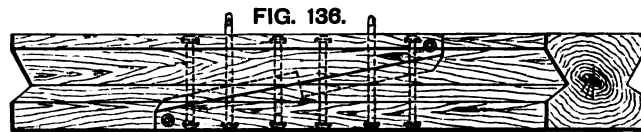
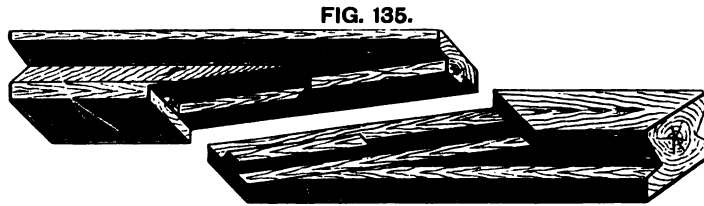

"tabling" and the sunken recesses into which the tabling fits. Fig. 136 shows the two parts in place, with the fastening bolts which assist the tabling in resisting tensile strains tending to open the scarph. The plan was an excellent one, but necessitated considerable

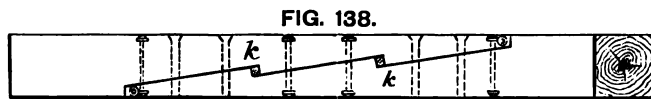
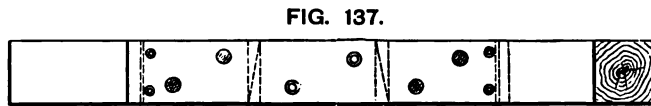

skill and cost of workmanship in fashioning the scarphs so that they might fit accurately. The same thing is true in the beam-scarphs, illustrated in side view by Fig. 137, and in plan in Fig. 138. This is termed a "hooked scarph," metal wedges or keys (*k, k*, Fig. 138)

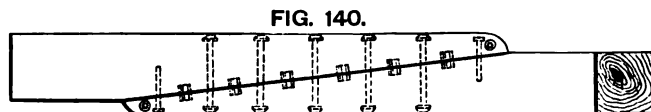
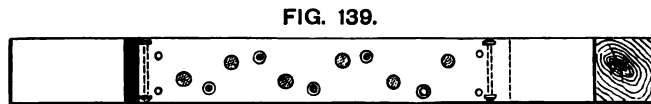

being driven to tighten up the scarph, and bolts and treenails being used to fasten it. This hooked scarph replaced the simple but less compact and satisfactory method illustrated in Figs. 139 (side view) and 140 (plan). The fastenings in this case consisted of dowels,

treenails, and metal bolts. Still another method of scarphing is illustrated in Fig. 141, and is known as a "plain scarph," being free from tabling and hooks. It is not nearly so strong against tensile strains as the preceding plans; but neither does it involve such care and expense in fashioning. The keelsons, shelf-pieces, and some other longitudinal ties, were frequently scarphed in this manner. It will be noted that in the last plan, and the preceding one, the fastenings have to contribute the whole resistance to separation of the scarph under tensile strains; and when these strains are acting, there is a tendency for the wood to yield in wake of the comparatively small and hard metal bolts.

The greater hardness and small size of the metal fastenings

FIG. 141.

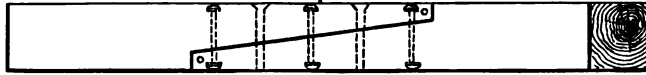

in a wood ship is a fruitful source of weakness and working. Parts, at one instant under tension, tend to yield in wake of iron or metal bolts; soon after, under compressive strains, the tendency disappears, to be followed almost immediately by its reappearance, if the ship is floating amongst waves. It will of course be understood that we are here dealing with tendencies only, and not with actual yielding; the existence of a large reserve of strength often preventing the tendency from passing into a sensible change of form. When ships are weak, it is otherwise, and then working takes place. The use of timber treenails as fastenings in the outside planking of a wood ship, or of coaks and dowels, also of hard wood, is from this point of view a considerable advantage. Coaks in particular, and treenails in some degree, have a larger "bearing" surface on the wood planks, etc., than have metal bolts; besides which they are not so hard, both of which differences tend to lessen the local yielding of the pieces fastened by them.

An assemblage of wood planks or timbers, such as is found in the outside planking, or the flat of a deck, is not usually dealt with by scarphing adjoining pieces together. Plain butt-joints are then had recourse to (see Fig. 125, p. 349), and the weakness of the butted strakes on any transverse section is met by the device, previously explained, of "shift of butts." This is, however, tantamount to a reduction of the total sectional area by *one-fourth*, when resistance to tensile strains is being considered; and the holes for bolts and treenails necessitate a further deduction.

Such are the best results obtained either in timber-ties (like the keel, or beam, or shelf-piece) or in an assemblage of planking.

Either scarping of an elaborate and expensive character must be adopted, or shift of butts must be trusted. In all cases, moreover, the greater hardness and small surface of the metal bolts tend to produce yielding of the wood in wake of them when the parts are under tension.

In every one of these particulars iron and steel gain upon wood. The rivets forming the fastenings of piece to piece are of the same degree of hardness as the plates or bars; so that yielding in wake of them is not to be feared. What must be secured is that the riveting is properly done, and the holes in the plates, etc., well filled by the rivets. Again, when two plates or bars have to be joined to form a tie, nothing can be simpler than the connection. The pieces may either be lapped and riveted, as in Fig. 142, or butted and strapped, as in Fig. 143. In either case the shearing strength of the rivets may be made to fix the ultimate resistance of the tie under tension. With the lap joints of Fig. 142 the resistance to

FIG. 142.

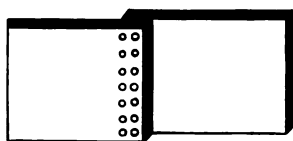
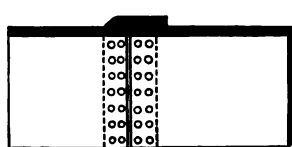

FIG. 143.



compression is also measured by the shearing strength of the rivets; whereas in Fig. 143, if the butts are carefully fitted, the rivets in the straps need not sustain any shearing strain under compression, so long as the plates are prevented from buckling.

The butts in a strake of plating are not necessarily such sources of weakness as are the butts in a strake of planking, because the butt-strap gives great tensile strength to the butts, and may be made to render the section of the plating in wake of a line of butts quite as strong as its section in wake of the lines of rivet-holes at adjacent transverse frames.* Shift of butts is had recourse to also in assemblages of plating, but it is of less importance than in assemblages of wood planking. On the whole, in a well-built vessel, the effective sectional area of an assemblage of plating against tensile strains is probably not far from *seven-eighths* of the total sectional area, as compared with *five-eighths* for the skin of a wood ship. It is unnecessary to repeat what was said in the previous chapter respecting the further gain of the iron skin, on account of

* See a paper contributed by the author to the *Transactions* of the Institution of Naval Architects for 1873. The subject is too technical to be discussed in these pages.

the efficient edge connections of strake with strake, although this is an important advantage.

When subjected to *bending moments*, combinations of iron and steel plates and bars can be easily converted into flanged or hollow girders, or into cellular structures, capable of bearing equally well tension or compression. The double bottoms of iron and steel ships have already been fully described; and many other illustrations have been given in previous pages of the facts to which attention is again directed, because of their important bearing on the association of strength with lightness. It is consequently unnecessary to amplify the statement. From the nature of the material, timber must be used in solid masses, and not in flanged forms; the several pieces in a combination have connections which are weak under tension; and these imperfect connections are costly and difficult to make, besides being liable to working and increased weakness with repetitions of severe straining forces.

Comparative Weights of Wood, Iron, and Steel Ships.—From the foregoing statements, it will be obvious that with equal structural strength a ship of given size and type can be built with a less weight of iron than would be necessary with wood, and with a less weight of steel than of iron. Savings in the weight of hull render possible corresponding increases in the carrying power. The extent to which these savings may be carried varies in different classes of ships; and there is a necessity to bear in mind the character of the service for which a ship is designed, when comparing her weight of hull with that of a ship of a different class. Besides the materials worked into the structure for the purpose of giving it strength and rigidity, more or less considerable weights are added in the form of fittings or accommodation, which contribute but little, if at all, to the structural strength, and yet are included in the weight of hull. Cargo-steamers, for example, have a minimum weight devoted to fittings, the hold-spaces being kept clear for cargo. Passenger-steamers, on the contrary, are elaborately fitted for the accommodation of passengers, and considerable weights are involved. War-ships are still more elaborately fitted, every portion of the interior being devoted to and arranged for specified purposes of stowage or accommodation, while the subdivision is very minute. Every endeavour is made to utilize bulkheads, platforms, partitions, etc., fitted primarily for accommodation as contributories to the structural strength. But after this has been done there remains a considerable weight of material, reckoned into the hull, yet really constituting only a load to be carried. This group includes fittings in magazines, shell-rooms, store-rooms, cabins, crews' quarters, etc.; and arrangements for pumping, drainage, ventilation, electric lighting, working the

cables, hoisting the boats, and other necessary services. Further, considerable weights are expended on strengthening the bows for ramming, the sides behind the armour-plating, the decks, etc., for carrying guns and withstanding the shocks of gun-fire, and meeting other requirements incidental to the use of ships as fighting machines. As between different types of war-ships, these supplemental demands for fittings and strengthenings necessarily vary greatly. The height of freeboard; numbers, disposition, and protection of guns; system of hull-protection, engine-power, and speed,—all affect the weight of hull. Hence broad comparisons of weights of hull—say as percentages of the load displacements—require to be supplemented by detailed analysis, and the ship-designer is careful to separate in his calculations the weights of materials contributing to the structural strength, from the weights of accessories and fittings.

Generalizations respecting the variations in structural weights accompanying variations in dimensions, have been attempted repeatedly by capable investigators. The late Mr. W. Froude was one of the first to attempt the solution of this problem. He showed that, for similar ships placed on similar waves, the longitudinal bending moments varied as the cubes of the lengths, and directly as the breadths; or as the fourth power of the lineal dimensions. Treating the parts of the structure contributing resistance to longitudinal bending as a box-girder, he remarked that the stress on the decks, bottoms, and sides varied as the quotient of the bending moment divided by the depth. Consequently, if the stress was to be kept at a constant maximum value in similar ships, the sectional areas of materials in decks, bottoms, and sides would have to be varied as $(\text{length})^3 \times \text{breadth} \div \text{depth}$; and the structural weights as the $(\text{length})^4 \times \text{breadth} \div \text{depth}$. That is to say, the structural weights, for *equal stresses* under longitudinal bending in ships of different dimensions, should vary as the *fourth* power of the lengths; or as the *four-thirds powers* of the displacements.* It has been shown in the previous chapter that the stresses on ships of large dimensions exceed those usually experienced in ships of smaller dimensions. Further, it has been explained that considerations of local strength or durability, especially in vessels of small size, frequently determine the minimum scantlings which can be accepted and so cause the stresses incidental to longitudinal bending moments to be smaller than could be accepted apart from these considerations. Nor must it be forgotten that in ships of similar form, but greatly differing dimensions, the structural arrangements are different, the

* See a paper on "Useful Displacement," in the *Transactions* of the Institution of Naval Architects for 1874.

numbers of decks are not identical, the bottom is differently built, or other changes made, affecting the equivalent girder for longitudinal bending and the resistance offered to transverse change of form. In these and other ways, in practice, the theoretical conditions assumed in generalizations of the character described are departed from.

This remark applies also to the able investigation published by M. Normand, in 1892.* His conclusions may be summarized. For equal stresses under longitudinal bending moments, in ships of different absolute dimensions and different ratios of length to depth and breadth, he considers the structural weights should vary as—

$$\left(\frac{\text{length}}{\text{depth}}\right)^{\frac{2}{3}} \times (\text{displacement})^{\frac{4}{3}}$$

The weights of transverse framing, bulkheads, beams, etc., are assumed to vary as $(\text{displacement})^{\frac{4}{3}}$ in ships where the absolute dimensions only are varied. The total structural weights (longitudinal and transverse) are assumed to vary as—

$$\left(\frac{\text{length}}{\text{depth}}\right) \times (\text{displacement})^{\frac{4}{3}}$$

M. Normand justly adds, "Whatever may be the true law of variation of weight as a function of the ratio of the length to the transverse dimensions (depth and breadth), it is certain that a notable lightening can be realized by diminishing that ratio." This is a confirmation of a long-accepted principle in ship-construction.

The ordinary method of making comparisons between ships is avowedly inaccurate except when applied within comparatively narrow limits of size and to ships of similar type. It expresses the weight of hull—including both structure proper and fittings—as a percentage of the load-displacement. Keeping in mind the foregoing remarks, the following facts will be of some value, and will illustrate the advantages obtained by changing materials of construction.

In wood-built ships of the Royal Navy the weight of hull (including fittings) was about 50 per cent. of the load displacement. In wood-built ships of the mercantile marine, less elaborately fitted, the hull weighed from 35 to 45 per cent. of the displacement. Even the largest wood-built ships were of very moderate size, proportions, and speed, as compared with the iron and steel vessels which have succeeded them. And this fact must be borne in mind when comparing percentages for weights of hull.

* See *Bulletin* de l'Association Technique Maritime, No. 3.

In iron-built cargo-steamers and sailing ships the weight of hull may be taken as from 25 to 30 per cent. of the displacement. For ships of equal dimensions, it has been estimated that the change from wood to iron effected a saving of about *one-third* on the weight of hull. Iron passenger-steamers, with their elaborate fittings, have relatively greater weights of hull, varying from 45 to 55 per cent. of the load-displacements. In such vessels the percentage of weight, contributing little, if at all, to the structural strength, is from twice to thrice as great as the corresponding percentage in vessels which are purely cargo-carriers.

Armoured war-ships with iron hulls were at first heavily built, the hulls (including fittings) averaging about 55 per cent. of the displacement. These were armed on the broadside principle, and many of them were of considerable length. Improvements in structural arrangements and reductions in length resulted in savings in weight of hull, bringing it down to 40 to 45 per cent. of the displacement in the later broadside ships. Turret-ships with moderate freeboard, and carrying, at most, four heavy guns, had weights of hull amounting to 30 or 35 per cent. of the displacement. The iron hulls of the Russian circular ironclads weighed only about 20 per cent. of the displacement.

For iron-built unarmoured ships of the Royal Navy, the weights of hull ranged from 40 to 50 per cent. of the displacement; and in troop-ships was practically the same as in passenger-steamers.

Perhaps the savings in weight will be more fully realized if an example is given. The *Black Prince*, one of the earliest seagoing ironclads, was of 9250 tons displacement, and her iron hull weighed nearly 5000 tons. The *Alexandra*, one of the latest broadside ironclads, with iron hull, was of 9500 tons displacement, and her hull weighed only 3800 tons. By improved construction, fully 1000 tons was, therefore, transferred from hull to carrying power in the *Alexandra*.

Steel ships, being built of a stronger material, are lighter than iron ships. In the earlier steel vessels, wherein material of high tensile strength was used, the reductions in scantlings usually varied from *one-third* to *one-fourth* of the scantlings used in iron for ships of the same sizes. In a few cases the reductions were even greater, amounting to *one-half* as compared with iron, the tensile strength of the steel rising as high as 50 tons to the square inch. With mild steel of the quality now used, having an ultimate tensile strength of 26 to 32 tons per square inch, less reductions are made. Lloyd's Rules at first permitted of a reduction of 20 per cent. on the plates and frames of a ship built of mild steel as compared with a similar ship built of iron. This reduction in scantlings, of course, did not

apply to a considerable number of items included in the hull—such as forgings, fittings, woodwork, etc. Lloyd's now have separate tables for the scantlings of steel ships. Some authorities estimated that, on the original basis of reduction, the use of steel effected a saving of 12 to 15 per cent. on the weight of iron which would have been used in a ship of the same dimensions. In steel cargo-steamers of recent construction, the saving is said not to exceed 7 or 8 per cent. as compared with iron. It is this saving, and the consequent increase in carrying power which has chiefly led to the rapid substitution of steel for iron in recent years; although the greater uniformity and ductility of the material, its excellent working qualities, and improvements in manufacture, tending to great reductions in cost, have all contributed to the result. Steel ships are being built instead of iron because they are commercially more successful.

Two illustrations may be given of the gain in carrying-power. First, take an ordinary type of partial awning-deck cargo-steamer, for which the length is about 290 feet, and load-displacement 5000 tons. The weights would be distributed somewhat as follows, if 10 per cent. is saved on structural steel:—

	Iron ship. tons.	Steel ship. tons.
Iron or steel in hull	1100	1000
Other weights of hull and outfit	300	300
Total weight : hull and outfit	1400	1300
Machinery	260	260
	1660	1560
Carrying power : cargo and coals	3340	3440
Displacement	5000	5000

Supposing the ordinary supply of coal to be 340 tons, the iron ship would carry 3000 tons of cargo, and the steel ship 3100 tons, or about 3 per cent. more.

Second, take a passenger-steamer of good speed, about 500 feet long and load-displacement of 12,500 tons. The weights may be distributed as follows, if 14 per cent. is saved on structural steel:—

	Iron ship. tons.	Steel ship. tons.
Iron or steel in hull	5000	4300
Other weights of hull and outfit	1650	1650
Total weight : hull and outfit	6650	5950
Machinery	1750	1750
	8400	7700
Carrying power : cargo and coals	4100	4800
Displacement	12,500	12,500

In this case the use of steel practically adds *one-sixth* to the carrying power; and if a constant weight of coal is assumed for both ships, the proportionate gain would be greater on the remunerative freight. For instance, if 2000 tons of coal were necessary, say, on the Atlantic service, the iron ship could carry 2100 tons of cargo, and the steel 2800 tons—*one-third* more. The relative importance of the gain in carrying power in this and other cases may vary considerably in ships of different types, engaged in different trades, and performing voyages of different lengths at various speeds. When ships are built to perform definite voyages at stipulated speeds, then the use of steel instead of iron enables either heavier dead-weight cargoes to be carried on a given displacement, or a stipulated dead weight to be carried in a ship of less displacement and less cost.

The relative costs of iron and steel ships are necessarily dependent upon many circumstances, but chiefly upon the comparative prices paid for the materials. In 1877 steel was about twice as costly as iron in common use, which was (as explained above) an *untested* material, whereas steel was always tested rigorously. In the Royal Navy, where equally searching tests were applied to both materials, only a very short time elapsed before mild steel could be procured at a lower price than superior iron. The same thing happened in the French Navy. As the sources of supply of steel have been increased, while the processes of manufacture have been developed, so the price of steel has fallen. In 1880 steel was about 50 per cent. dearer than iron of ordinary shipbuilding quality. Even as prices then stood, it was considered profitable in many trades to build steel ships. The rapid advance of steel since 1887 is, however, largely to be attributed to its lower price. In 1887 steel was about *one-third* dearer than iron; in 1891 it was only about 10 per cent. dearer. Mild steel for shipbuilding has hitherto been made almost entirely from hæmatite ores, the greater part of which have been imported. It has been proved, however, that steel made from native British ores by the "basic" process can be used with safety, and this fact will probably exercise a sensible influence on the future supplies of steel.*

The development of cast steel in recent years has been remarkable, enabling shipbuilders in many cases to dispense with costly forgings, and to obtain the substituted castings at moderate cost and

* See papers by the author in the *Journal* of the Iron and Steel Institute for 1891 and 1892; and the *Transactions* of the Institution of Naval Architects for

1888. As to the relative prices of iron and steel, see the presidential address of October, 1892, to the North-East Coast Institution of Engineers and Shipbuilders.

in a comparatively short time. Stems, sternposts, shaft-brackets, rudders, etc., are now commonly made of cast steel instead of forged iron or steel. In war-ships the gain is most considerable, their ram-bows and under-water steering appliances necessitating special structural arrangements.

The use of mild steel in the hulls of war-ships has enabled substantial savings to be made on the weights contributing to the structural strength. In these vessels, as previously explained, iron of high quality fulfilling specified tests was always used. The tensile strength of mild steel may be taken as about 30 per cent. greater than that of the best qualities of iron formerly employed; but, having regard to all the circumstances, it was decided not to reduce scantlings more than 15 per cent. as compared with iron in any parts of the structures, and to secure the greater strength possible with steel of this relative thickness. Many internal portions of the iron structures had previously been made as thin and light as was consistent with durability; consequently for them the use of steel gave no saving in weight. Notwithstanding these limitations, the change from iron to steel led to considerable additions to the carrying power of war-ships, and facilitated the marked increase in their engine powers and speeds which has taken place since 1875. Some of the results obtained could scarcely have been realised with iron. Torpedo-boats, for example, built of excessively light steel plating and framing, have hulls strong enough to carry extremely powerful propelling machinery. In these remarkable vessels, with relatively high freeboard, the hulls weigh only about 30 to 35 per cent. of the displacement, including all fittings. The propelling apparatus commonly weighs more than the hulls; while loads of armament, coals, and equipment are carried weighing in the aggregate nearly as much as the hulls. Yet in actual service at sea indications of weakness have been extremely rare, and nearly always local in character.

As an illustration of the distribution of the weights in a steel-built first-class battle-ship of the present day, the following figures may be given:—

	Percentage of displacement.
Materials contributing to structural strength	18
Accessories and fittings to hull	20
	—
Total weight of hull	38
Propelling machinery and coals	15
Armour and protective material on decks, etc.	30
Armament and equipment	17
	—
	100
	2 E

In the last group are included large weights of machinery used for auxiliary purposes, such as working the heavy guns, doing the cable work, hoisting heavy boats, etc., besides the guns and their mountings, ammunition, torpedoes, provisions, stores, etc. The protective material, especially the deck plating, is so disposed that it shall assist in resisting both transverse and longitudinal strains as far as possible; but its primary purpose is to give defence. This summary indicates how small a portion of the total displacement has to furnish the greater part of the strength required to resist strains incidental to service at sea, to the attainment of high speeds, and the carrying of great weights of armour and of armament.

For a typical swift protected cruiser of high speed, large coal-supply, and heavily armed, the weights are distributed as follows:—

	Percentage of displacement.
Material contributing to structural strength	20·5
Accessories and fittings to hull	17·5
Total weight of hull	38·0
Propelling machinery and coals	35·0
Protective material	16·0
Armament and equipment	11·0
	100·0

Developments in Dimensions and Speeds.—The use of iron and steel hulls has been accompanied by great increase in the dimensions, proportions, and speeds of ships. No such developments would have been possible with wood. In the later periods of wood shipbuilding for war purposes, when it was considered undesirable to adopt iron hulls because of their supposed inferiority to wood when exposed to an enemy's gun-fire, there were many evidences that the limits had been reached for which the material was suitable. Great engine power, considerable lengths, and high speeds were features which could not well be secured in wood ships. The latest and largest frigates in the Royal Navy, the swift cruisers built in America during the Civil War, and many other similar cases, illustrated this fact. Such vessels required considerable repairs during their short periods of service, and soon fell into disuse. First with iron, and now with steel, it has been shown that there are no such limitations as occurred with wood. Commercial considerations, in fact, govern the sizes and speeds of mercantile vessels; and other considerations—cost in great measure—determine the upper limits of size for war-ships. The *Great Eastern* was a crowning example of the capabilities of iron. She was 680 feet long, 83 feet broad, of nearly 19,000 tons (gross tonnage), and had a load displacement of over 32,000 tons

when laying submarine telegraph cables. Throughout her period of service, extending over twenty years, she was proved to possess ample structural strength. No other vessel has yet been built of equal size. In the Atlantic service, however, recent progress has narrowed the gap between the largest mercantile steamers and the *Great Eastern*. The *Campania* and *Lucania* of the Cunard line are 600 feet in length, 65½ feet in breadth, 12,500 (gross) tons in measurement, with a load displacement of 18,000 to 19,000 tons. On service it is anticipated they will eventually average about 22 knots per hour, developing 25,000 H.P. to 30,000 H.P.* This is a wonderful advance in half a century. The *Great Britain* of 1840, built of iron, was regarded at the time as a vessel of extraordinary dimensions. Her length was 290 feet, breadth 51 feet, and register tonnage 3270 tons, with an original load displacement approaching 6000 tons. The wooden *Great Western*, which preceded her in 1838, was large for those days. Her length was 210 feet, breadth 35½ feet, and load displacement 2300 tons. On every other line of steamship traffic similar increases in dimensions and speeds have taken place, and have been made possible only by the use of iron and steel.

In war-fleets the use of these materials has been equally associated with developments in size and speed. The table on the following page illustrates this fact. It deals exclusively with ships of the Royal Navy, in which, concurrently with the changes indicated in the table, there have been remarkable advances in powers of offence and defence, weights and thicknesses of armour, and weights and powers of guns.

Comparative Durability of Wood, Iron, and Steel Ships.—For some years after the introduction of iron ships it was a matter of dispute whether they would prove as durable as wood ships. The experience of half a century has settled this matter definitely in favour of iron; and the disappearance of wood shipbuilding in this country makes any statement on the subject one of historical interest only. A very brief summary of facts will suffice, therefore.

There are many examples of great durability in wood ships. These are exceptional cases, however, and did not enable shipbuilders to increase the *average durability* of wood ships. The *Sovereign of the Seas*, built at Woolwich in 1635, was rebuilt forty-seven years later, and the greater part of the original materials are said to have been again used. The *Royal William*, built about 1715, remained on service for ninety-four years with only three slight repairs. In the

* An admirable account of these remarkable vessels appears in *Engineering* of April 21, 1893.

mercantile marine there have been instances also, chiefly in small vessels engaged in special trades, of continued service for about a century. On the other hand, there are numerous instances where wood ships, hurriedly built of unseasoned timber, have rapidly decayed

Class of ship.	Date of construction.	Name.	Displacement.	Indicated horse-power.	Length.	Breadth.
<i>Wood unarmoured.</i>						
Largest sailing three-deckers	1815	<i>St. Vincent</i> . .	4,700	—	205	53 $\frac{1}{2}$
„ screw „	1859	<i>Victoria</i> . .	6,950	4,190	260	60
„ „ two-deckers	1860	<i>Duncan</i> . .	5,700	2,820	252	58
„ „ frigates	1857	<i>Orlando</i> . .	5,600	4,000	300	52
<i>Wood, armoured.</i>						
Largest class	1863	<i>Lord Warden</i> . .	7,840	6,700	280	59
<i>Iron, unarmoured.</i>						
Swift cruising frigate . .	1866	<i>Inconstant</i> . .	5,780	7,360	337	50 $\frac{1}{2}$
<i>Iron, armoured.</i>						
Early broadside ships . .	{ 1859	<i>Warrior</i> . .	9,100	5,470	380	58
	{ 1861	<i>Minotaur</i> . .	10,600	6,700	400	59 $\frac{1}{2}$
Modern	{ 1865	<i>Hercules</i> . .	8,700	8,530	325	59
	{ 1873	<i>Alexandra</i> . .	9,500	8,600	325	63 $\frac{3}{4}$
Turret ships of moderate freeboard	{ 1869	<i>Devastation</i> . .	9,290	6,650	285	62 $\frac{1}{2}$
	{ 1871	<i>Dreadnought</i> . .	10,890	8,000	320	63 $\frac{3}{4}$
	{ 1874	<i>Inflexible</i> . .	11,900	8,000	320	75
<i>Steel, protected.</i>						
First-class cruiser	1888	<i>Blenheim</i> . .	9,000	20,000	375	65
<i>Steel, armoured.</i>						
Turret ships of moderate freeboard	{ 1885	<i>Victoria</i> . .	10,470	14,000	340	70
	{ 1885	<i>Trafalgar</i> . .	11,940	12,000	345	73
Barbette ship of high freeboard	1889	<i>Royal Sovereign</i>	14,200	13,000	380	75

and become unserviceable. Cases in point are to be found in the gunboats built for the Royal Navy during the Crimean War; and in the war-ships built for the United States Navy during the Civil War. A consideration of all the facts on record leads to the conclusion that in wood ships built of seasoned materials, and with all proper precautions to preserve the timbers and planks from dry-rot and other kinds of decay, from twelve to sixteen years is a fair estimate of average durability for seagoing vessels properly used and kept in good repair. After that period wood ships may be kept going, but the repairs would be usually considered too costly to be undertaken.

Iron is not subject to the internal sources of decay to which timber is liable. Worms or marine animals cannot penetrate iron as they do comparatively soft timber. Imperfect ventilation and many

other circumstances which cause wood to rot do not affect iron similarly. Moreover, in a well-built iron ship there ought not to be any sensible *working* of the several parts and their fastenings; whereas in wood ships of large size the entire prevention of such working is practically impossible, and in it is found a fruitful source of weakness or decay. In iron ships the special danger requiring to be guarded against is corrosion or rusting of the surfaces of plates and bars. This danger is by no means insignificant, and the principal causes of corrosion will be dealt with hereafter, as well as the precautions necessary for its prevention. Here it will suffice to say that corrosion is practically preventible; and that the experience of half a century proves that with proper treatment, and at moderate expense, the structures of iron ships can be maintained in a sound and efficient state for very many years. Their woodwork and fittings, of course, require renewal or repair as in wood ships.

Experience shows that the period of employment of iron ships, when they are properly cared for, and apart from accident, is usually determined by other considerations than deterioration or decay in the structures. Improvements in shipbuilding and marine engineering, following one another in rapid succession, make it impossible to continue the employment of older vessels in the trades for which they were originally built, in competition with vessels of more recent date. Consequently these older vessels gradually pass into other trades, and finally reach the stage when they are broken up; not because they are worn out or past repair like wood ships, but because they can no longer be profitably employed. In order to indicate the possible durability of iron ships apart from these commercial considerations, a few facts may be stated.

In the early days of iron shipbuilding the conditions necessary to the preservation of iron hulls were not so well understood as they are now. Yet many of these vessels served for long periods. The first iron steamer, the *Aaron Manby*, built in 1821, lasted thirty-four years. The *Nemesis* and *Phlegethon*, the earliest iron war-ships built for the East India Company in 1839, were employed for more than twenty years. The *Great Britain*, the first iron screw-steamer for Atlantic service, built in 1840, continued at work as a steamer for forty years, and was then turned into a sailing ship. The troop-ship *Himalaya* of the Royal Navy, built for the Peninsular and Oriental Company in 1855, is still (1893) on active service, and in good condition as to structural strength. The iron-hulled ironclads of the Royal Navy (*Warrior* and *Minotaur* classes) dating from 1859-61, are as strong as ever in their iron structures, and not yet past active service.

Steel ships, properly cared for, will undoubtedly prove equal to iron ships in durability. In some respects experience appears to

indicate the necessity for special precautions in the treatment of steel, particularly under engines and boilers. The less thicknesses of plates and bars accepted with steel as compared with iron make it very desirable to ensure the protection of the surfaces from corrosion by cleaning and painting or cementing. These are, however, matters of practical detail easily arranged, and, subject to these precautions, steel ships will doubtless resemble iron in passing out of service in the mercantile marine chiefly because of the introduction of improved types. Some of the earlier steel-built steamers, with very light scantlings, have continued at work for very long periods. The first ships of the Royal Navy built of mild steel have now been afloat nearly twenty years, and are as strong and sound in structure as they were originally.

The Corrosion of Iron and Steel Ships.—Reference has been made to the danger of serious rusting and corrosion in the structures of iron and steel ships unless proper care is taken. The subject is important, and will be further noticed. The conditions tending to promote corrosion are of many kinds, operating both inside and outside ships. Parts of the hull above water are least likely to suffer; but even these on the outside have to sustain the action of air, water, and weather, and in the inside are exposed to changes of temperature, the condensation of vapour, and other circumstances tending to cause rust. Parts of the hull under-water are much less favourably situated. The outside surface of the bottom plating is immersed in corrosive sea-water, and differently constituted sea-waters affect iron or steel in different ways. In the hold-spaces the plating, frames, etc., often have to sustain the action of bilge-water, which has a strong corrosive action if left unchecked. Coal and many other substances carried as cargo may produce a chemical action on the surfaces of plates and bars which accelerates corrosion. Under engines and boilers the drippings of oily matters into the bilges, and their accumulation there under relatively high temperatures involve special dangers. In machinery and boiler spaces there are great alternations of temperature, the condensation of steam upon the surfaces of plating and framing, and the production of gases more or less effective in aiding corrosion. Galvanic action may be set up in parts of the structure immersed in sea or bilge-water by the metallic connection of copper, brass, or lead pipes with the hull. In such cases there is a risk of corrosion becoming both rapid and local.

These are the principal causes of corrosion, and their enumeration will show how many and varying are the conditions upon which the rate of corrosion would depend if left unchecked. Other than extraneous causes affect practical results. The want of homogeneity in the various parts of the same plate or bar may cause corrosion to

begin or accelerate its progress. Plates and frames of apparently identical quality are often differently affected by corrosion, and so are different parts of the same plate or frame. Patches are discovered where corrosion has proceeded with extreme rapidity, or "pitting" takes place, and corrosion is greatly localized. No general laws can be formulated respecting the rates of corrosion of iron and steel. Laboratory experiments, or the exposure of sample test-pieces to conditions intended to represent those of service, while they are valuable sources of information, cannot take the place of experience in actual ships. A brief reference to some of the results obtained from these experiments will suffice.*

As illustrations of the different rates of corrosion arising from differences in the water acting on iron or steel, the following facts may be cited. Mr. Mallet found that iron boiler-plates immersed in *clear* sea-water lost from .007 to .009 lb. per square foot per month; whereas in *foul* sea-water the loss was about twice as great. Mr. Parker found that iron discs of which the surfaces were bright, the "scale" having been removed, lost from .0136 to .0163 lb. per square foot per month in sea-water, and three times as much (.042 lb.) in bilge-water. Steel discs similarly treated lost .0172 lb. in sea-water, and .0436 lb. in bilge-water. Dr. Calvert and Mr. Johnson found that iron lost .0056 lb. per square foot per month when immersed in a vessel of sea-water, and .0204 lb. when immersed in the sea.

These experiments have proved also that the oxides of iron and steel are electro-negative to those materials; so that when a plate or bar immersed in sea-water has upon it the manufacturer's "scale," or becomes rusty, the rate of corrosion on any exposed portions of the surface will be accelerated by the galvanic action set up on them by the oxides. Extensive trials made by the Admiralty in the early days of steel shipbuilding showed this to be true, particularly for steel; and as a result the manufacturer's scale, which adheres much more strongly to steel plates than to iron, is now removed from the surfaces of plates that will be immersed in sea or bilge water before they are used in her Majesty's ships. For this purpose the plates are immersed in a bath of dilute hydrochloric acid, and subsequently washed with fresh water. In this manner at small expense clean

* See *inter alia* papers by Mr. R. Mallet, in *Reports* of British Association, 1841-43, and in vol. xiii. of the *Transactions* of the Institution of Naval Architects; by Dr. Calvert and Mr. Johnson in *Transactions* of the Literary and Philosophical Society of Manchester,

1865; by Mr. Parker and Professor Crum Brown in *Journal* of the Iron and Steel Institute for 1881 and 1888; and by Professor Lewes in vols. xxviii. and xxx. of the *Transactions* of the Institution of Naval Architects.

surfaces can be obtained, and pitting or rapid local corrosion greatly lessened or prevented. Some private firms follow the same practice for steel plates. As a rule, however, merchant ships are built in the open air, and builders are content to allow the surfaces to rust for a time, trusting to "scaling" before painting to remove the dangerous oxide. This answers well for iron ships, and is the usual practice for steel ships. Illustrations of the possible effects of scale upon corrosion are given by Mr. Parker, who states that in sea-water black discs of iron and steel with the scale left on had their rates of corrosion increased from 2 to 3 times, as compared with bright discs with the scale removed. In other test-pieces immersed in bilge-water, many of the discs with scale on suffered less than the bright discs; but in practice this is not found to be true.

Laboratory experiments indicate a slightly greater rate of corrosion in steel than in iron. There are, however, so many varieties of steel that caution is necessary in dealing with the results. The earlier experimentalists probably tested steels of higher tensile strength than that now used; these lost from 6 to 7 per cent. more than iron when immersed in sea-water. Kerm's experiments of 1877 showed a correspondingly greater loss for steel—about 18 per cent. Mr. Parker's experiments with mild steel showed that under similar conditions it lost by corrosion nearly at the same rate as the superior qualities of wrought iron.

Galvanic action, set up on iron or steel plates and bars by copper, brass, or lead pipes and fittings in metallic connection with the structures of ships and immersed in sea or bilge-water, may greatly accelerate local corrosion, and in many cases holes have in this way been eaten through the skins of ships. Caution is necessary, therefore, to prevent such galvanic action, and there is no great difficulty in doing so.

To illustrate the greatly increased rate of corrosion incidental to galvanic action, a few examples may be taken from the results of the experiments recorded by Mr. Mallet. An iron plate immersed *alone* in clear sea-water was found to lose during a certain period a quantity which we will denote by unity: it was then immersed for an equal time in clear sea-water with an equal surface of the following metals electro-negative to it, and the corrosion increased as follows:—

Experiments.	Relative corrosion.
Iron plate in contact with copper	4.96
" " " brass	3.43
" " " gun-metal	6.53
" " " tin	8.65
" " " lead	5.55

Other laboratory experiments, made on an extensive scale, have given different results for the relative intensities of the action of the various metals on the iron; but they fully confirm the fact that a greatly increased rate of corrosion results from galvanic action. The first two materials, copper and brass, are those of which the ship-builder has need to take most heed in arranging the sheathing or fittings of iron or steel ships.

Under the conditions of practice, the losses in thickness by corrosion are usually less than those indicated by the laboratory experiments, which are made on bare plates, and mostly on small surfaces, over comparatively short periods. There are cases, however, where the skin plating and frames of ships have corroded more rapidly than the laboratory samples would lead one to expect. For example, in H.M.S. *Megæra*, built at an early period of iron ship-building when the proper means for preservation were not so well understood, fifteen years' service reduced the thickness of many plates on the bottom by fully $\frac{1}{4}$ inch. The corresponding loss in weight per square foot was about 10 lbs., or about an average of .0555 lb. per month, if the wear is assumed to be uniform over the surface of the plates. This will be seen to exceed considerably the greatest losses above-mentioned for iron plates immersed in foul sea-water or bilge-water. Laboratory experiments differ among themselves as regards rates of corrosion for the reasons above stated. It may be interesting to add, however, that a large number of these experiments indicate a loss of thickness for iron plates immersed in sea-water not exceeding $\frac{1}{2}$ inch to $\frac{5}{8}$ inch in a century.

Turning from laboratory experiments to experience in actual ships, with structural arrangements designed to facilitate examination, cleaning, and painting, and with proper care taken to remove rust and scale from the surfaces in order that they may be protected by paint, varnish, or cement, it may be said that serious corrosion need not be feared in iron or steel ships. Periodical inspection, cleaning and painting are absolutely essential to the preservation of such ships. Neglect of these simple precautions may cause serious deterioration. With ordinary care in designing the structures, there need be very few parts not readily accessible when ships are cleared for survey and repairs. There should be none, bounded by the skin plating, absolutely inaccessible, unless they are filled with cement or other water-excluding material. Under engines and boilers there may be places difficult of access in some types of ships; but, as above explained, these are just the parts where there is the greatest need for precautions against corrosion, and in arranging the structures access should be secured.

There are very many kinds of "protective" paints, varnishes, and

cements in use for the prevention of corrosion on the insides and outsides of iron and steel ships. Rival claims to superior excellence are naturally put forward; but it would be out of place here to say more on the subject than that shipbuilders and shipowners can now procure many trustworthy "protectives," each of which possesses some special excellence. Facts might be multiplied in support of the very slow deterioration of iron and steel ships properly constructed and cared for. No better evidence of this can be found than in the provisions of Lloyd's Rules, which do not contemplate an exhaustive survey and drill-tests of the actual thickness of plating until ships have been twelve years afloat. Less searching surveys have to be made at intervals of four years. If these prove satisfactory, another exhaustive survey and drill-testing is not required until a further period of twelve years has elapsed. Should plates have lost a good deal in thickness, they must be renewed; but such cases are not common in ships properly cared for and maintained. The iron-built ironclads of the *Warrior* and *Minotaur* classes are now thirty years old; the original bottom plating remains, and the vessels are practically as strong as ever. Steel ships have not, of course, a similarly long guarantee from experience. Some of the earlier ships built of high tensile steel have remained efficient for over twenty years, although their plating is very thin. Nearly as long experience has been obtained with the first ships built of mild steel; and here also it has been most satisfactory on the whole. One special precaution in steel ships—the removal of the manufacturer's scale—has been already mentioned. Another point of practical importance is that in new steel ships the protective coatings may not adhere so well at first to the surfaces as they do in iron ships. Consequently it is desirable to examine closely and in some cases to renew these coatings at first rather more frequently than in iron ships. This relative disadvantage disappears at later stages in the history of steel ships, when the protectives have become firmly adherent to the surfaces. "Pitting" has occurred in some steel-plated ships to a larger extent than is usual in iron ships. When the scale has been thoroughly removed, however, the liability to pitting is greatly diminished. Under engines and boilers in some steel-built ships of the mercantile-marine, considerable corrosion is said to have occurred; and it has been recommended to use iron floors and plating at these parts. General practice has not, however, followed this recommendation; and, as the steel manufacture extends, the use of iron for the minor parts of the internal structures is becoming less common than it was at first. An alternative plan is to use at these parts the full thickness in steel which would be used in iron.

In torpedo-boats and other small vessels with very light scantlings of steel, another method of preventing corrosion has been used. The outside plating, floor-plates, lower parts of bulkheads, etc., have been "galvanized"; that is to say, the surfaces have been first cleaned in an acid bath, and have subsequently been dipped into a bath of zinc. A coating of this metal is formed in this way, and upon it the protective paints or varnishes are applied. Methods for electrically depositing zinc are now being worked out, as alternative and possibly preferable to the old process of "galvanizing."

The regulations issued by the Admiralty for the preservation of iron and steel ships contain the best summary of the precautions necessary for that purpose with which we are acquainted. It will be sufficient to summarize the main points. *Galvanic action* of copper, brass, or lead upon the hull is to be prevented by making the lower pieces of suction-pipes, etc., which are immersed in the bilge-water, of iron, steel, or zinc or zincked iron wherever that is possible. Where copper or brass pipes are unavoidable, they are to be well painted or varnished, and covered with canvas in order to reduce their action on the iron. The gun-metal screw-propellers are also to be painted for the same reason, and bands of zinc, termed "protectors," are to be fitted near them, in order to concentrate the galvanic action of the propellers upon the protectors and save the bottom plating: this plan has answered admirably. In order to preserve the *inner* surfaces of the bottom plating below the bilge from the injurious effects of the wash of corrosive bilge-water from side to side as the ship rolls, cement is used, and has proved of great advantage to both merchant and war ships. Other surfaces of plates and bars in the interior are protected by suitable paints or compositions. All parts of the hull are ordered to be made as accessible as possible for inspection and repairs. In cases where parts are necessarily inaccessible under ordinary circumstances—such as under the boilers or engines, etc.—careful records are to be kept of them; and when opportunity offers, as during a thorough repair at a dockyard, all such parts are to be opened up and inspected. When a ship is in the reserve or on service, all accessible parts are to be inspected once a quarter, cleaned and painted when necessary. A more thorough survey is made by dockyard officers at specified periods when ships are at naval ports; then the only parts left unvisited are those which cannot be reached without great difficulty—as, for instance, spaces which can only be attained by lifting the boilers or machinery. The use of double bottoms facilitates a thorough examination, especially of the inner surface of the outer plating, and all the parts of the inner plating underneath engines and boilers. The outer surface of the bottom plating is to be sighted

at least once a year; it is protected by some anti-corrosive paint or composition, and if the annual examination shows it to be necessary, this protective material is renewed.

Such are the main points in the Admiralty regulations. Conformity to them must prevent any serious corrosion taking place; for rusting ought to be detected in its earlier stages, and the surfaces, being frequently cleaned and coated, ought not to suffer greatly. The system has now been in force for many years, and has worked most satisfactorily. In a modified form it is applied also to the preservation of the ironwork in the composite ships of the Royal Navy.

The Fouling of Ships.—When ships have been long afloat, various growths of marine plants and animals are found upon the bottoms. Such growths are usually described by the term “fouling.” Their character and extent depend upon many conditions, but their effect upon the speed is always prejudicial. It will be shown hereafter that a very moderate degree of roughness in the bottom of a ship involves a relatively large increase in fluid resistance to her motion, and in the power required to attain a certain speed. Consequently fouling is a matter of considerable practical importance, particularly in iron and steel ships.

Wood ships are subject to fouling unless their bottoms are covered with suitable metallic sheathing. In naval history frequent references are made to the marked superiority as regards the maintenance of speed possessed by metal-sheathed ships over ships with the wood planking exposed or simply coated with some protective material. Copper, Muntz metal, and zinc are the three kinds of metal sheathing which have been most extensively employed on the bottoms of wood and composite ships. Although primarily employed to prevent serious fouling, these metal sheathings, of course, also protect wood planking from the attacks of worms and other marine animals.

The anti-fouling properties of copper sheathing are due to the fact that the action of sea-water upon its surface produces salts which are readily soluble, and do not adhere strongly to the uncorroded copper beneath. Hence the salts, instead of forming incrustations, are continually being washed off or dissolved away, leaving the sheathing with a smooth, clean surface, and preventing the attachment of plants or animals. Some chemists have ascribed importance to the poisonous character of the salts of copper in preventing fouling; but the foregoing is undoubtedly the more important feature, and is commonly termed “exfoliation” of the copper. The rate at which this wasting of the copper proceeds varies greatly under different circumstances and with different descriptions of copper,

and formerly this subject received much attention, the aim being to secure the minimum rate of wearing consistent with the retention of anti-fouling properties. For this purpose Sir Humphrey Davy suggested to the Admiralty the use of "protectors," formed of iron, zinc, or some metal electro-positive to copper. When these protectors were put into metallic connection with the copper sheathing and immersed, galvanic action resulted, the protectors were worn away, and the rate of wearing of the copper was decreased in proportion to the ratio of the surface of the protectors to the surface of the sheathing. When the protector had about $\frac{1}{100}$ of the surface of the sheathing, there was no wasting of the copper. With a smaller proportionate surface of the protectors the copper wasted somewhat; but even when the protectors had an area of only $\frac{1}{1000}$ part that of the sheathing, there was proved to be a sensible diminution in the rate of wearing. The limits of protection from fouling appeared to be reached when the surface of the protectors equalled $\frac{1}{150}$ part of the surface of the sheathing. After experience on actual ships it was found, however, that preservation of the copper by this means led to rapid fouling, and the plan was abandoned. Nor has any substitute been since found, the practice being to exercise great care in the manufacture of the copper, and to regard its wasting as the price paid for preventing fouling. Muntz metal—an alloy of copper and zinc in the proportions of about 3 to 2—has been used largely as a substitute for copper, especially in the ships of the mercantile marine, and appears to answer fairly well, being, of course, much cheaper than copper. Such alloys are supposed by some persons to have the advantage of not producing powerful galvanic action upon iron immersed in sea-water and metallically connected with them; but this property has not been definitely established. On the other hand, it appears that, after being long immersed, the alloy tends to alter in composition. Muntz-metal sheets have been found to become brittle after being some time in use; and the explanation given is that, the zinc being electro-positive to the copper, galvanic action is established between the two metals in the alloy, and part of the zinc removed. Muntz-metal bolts have also been found to perish through galvanic action, under certain circumstances, when immersed in sea-water. The addition to the alloy of a third metal, such as tin even in very small quantities, appears to prevent this objectionable change.

In the Royal Navy an alloy known as "naval brass" is used instead of Muntz metal for securities in gun-metal castings, or in connection with copper sheathing, under water. This alloy consists of 62 per cent. of copper, 37 per cent. of zinc, and 1 per cent. of tin. It answers admirably for bolts, and trials have been made with it

rolled into sheets and plates of a thickness suitable for the bottoms of ships. As regards strength and ductility the trials were satisfactory; but difficulties arose in connection with the riveting and watertight work on the thicker plates. The great expense of naval brass sheets, as compared with iron or steel, would prevent their extensive use in ship-work apart from other considerations; but in certain special circumstances their use might have been permissible had the trials proved wholly satisfactory. In fact, somewhat similar alloys have been used for the construction of a few torpedo-boats.

Zinc is another material which has been largely used for sheathing the bottoms of wood ships. When immersed in sea-water, the salts formed on the surface of a zinc sheet are very much more adherent to the uncorroded zinc than are the corresponding salts of copper, and are comparatively insoluble—or perhaps, we should say, are slowly soluble—by ordinary sea-water. Hence it appears that a coating of oxychloride of zinc, etc., is likely to form on the sheathing, not being washed away or removed like that on copper; and consequently zinc does not possess such good anti-fouling properties as copper, nor present such a smooth surface. It lasts for a considerable time under ordinary conditions. In some waters, however, and those of the tropics especially, zinc sheathing has been found to perish very quickly, owing probably to such a composition of the water as favoured the rapid solution of the salts formed on the surface, the exposure of the uncorroded zinc, its rapid oxidation, and so on. One commission on the African coast is said to have sufficed to strip the bottom of zinc and leave the wood exposed in H.M.S. *Trinculo*, fouling of course ensuing. Other cases are reported where zinc sheets $\frac{1}{8}$ inch thick have, under exceptional conditions, been worn through in the course of twelve months. Under ordinary conditions, zinc sheathing is much more durable; in fact, to increase its anti-fouling qualities, it has, in some cases, been put into communication with a metal, such as iron, which is electro-negative to itself, in order that the galvanic action which is produced may have the result of keeping the surface of the zinc freer from incrustations to which marine plants and animals can adhere.

Fouling is a much more serious matter in iron or steel ships. It may take place to a considerable extent without any considerable corrosion accompanying on the outer surface of the bottom plating; but as a rule it may be said that corrosion and fouling, although distinct, are closely related. Corrosion, when it is developed on a large scale, certainly tends to make fouling more rapid. When protective paints or compositions do their work well and minimize corrosion, there is much less risk of serious fouling. Some persons have affirmed that if all rusting were prevented, the bottoms of ships

being kept smooth and clean, the plants and animals could not attach themselves. There are many objections to this opinion, but it is needless to dwell upon them. In practice, the bottom plating, being subject to continuous immersion in corrosive sea-water, and to the wear and tear of service, cannot possibly be kept smooth and clean. Even with the best protective and anti-fouling compositions applied to the bottoms, iron and steel ships cannot remain afloat in sea-water more than a year without becoming so foul as to suffer a serious loss of speed. Very frequently this result is reached in a much shorter period. For economical reasons steamships of high speed are frequently docked, and have their bottoms cleaned and recoated twice or thrice in the year.

The prevention of fouling has naturally attracted much attention, numberless proposals having been made with the object of checking the attachment and growth of marine plants and animals, which go on more or less rapidly on iron and steel ships in all waters, and especially in warm or tropical seas. Various soaps, paints, and varnishes of a greasy character have been proposed for the purpose of rendering the attachment of these marine growths difficult, and of securing a gradual washing of the bottom when the ship is under weigh. Many others have been suggested having for their common object the poisoning or destruction of these lower forms of life. Sheets of glass, slabs of pottery, coatings of cement, enamelling, and many other plans for giving a smooth polished surface to the bottom, in order to prevent the adhesion of plants and animals, have been recommended, and in several instances tried, but not with much success. In fact, it would be difficult to point to any other subject which has been the basis of so many schemes and patents with so little practical advantage. Between 1861 and 1866 over a hundred plans were patented for preventing fouling, and in the subsequent period inventors have been quite as busy. No cure for fouling has yet been devised, nor, from the nature of the case, is one likely to be discovered. Much has been done in the improvement of anti-fouling compositions, particularly in relation to their rapid application under practical conditions when ships are docked for cleaning and recoating. This improvement has been associated with similar changes in the protective (or anti-corrosive) compositions. The result has been an efficient protection of the bottoms from corrosion, a reduction in the cost, and more uniform results with the anti-fouling compositions than were common heretofore. Docking accommodation has also been largely increased in all parts of the world, thus adding greatly to the facilities for cleaning and recoating the bottoms of iron and steel ships.

War-ships benefit as well as merchant ships from the increase

in docking accommodation. For certain classes of war-ships, however, it has been considered necessary to retain copper sheathing, so that they might keep the sea for long periods without serious fouling and loss of speed. Hence has arisen the construction of "composite" and "sheathed" ships. Composite ships, as already explained, differ from iron or steel ships in having wood skins, to which metallic sheathing can be nailed. Formerly that method of construction was used in the mercantile marine, chiefly for sailing ships. The China tea-clippers were so built. Now the plan is rarely used, except for yachts. In the Royal Navy and in foreign navies the system has been extensively employed for gunboats, sloops, and corvettes, up to about 2000 tons displacement. The principal difference between mercantile and naval practice is found in the outside planking of composite ships. Merchant ships have usually had one thickness of plank, secured to the ribs by screw-bolts. When these bolts have been of iron, they have often deteriorated rapidly under galvanic action, resulting from the copper or Muntz-metal sheathing. With brass bolts much more satisfactory results have been obtained. Composite ships of the Royal Navy, as explained at p. 375, have two thicknesses of planking. The inner thickness is fastened to the frames with naval brass screw-bolts, and the outer thickness is secured by copper through bolts spaced between the frames. This plan has been found to answer well for long periods of service.

For larger classes of war-ships having greater engine-power, it has long been the practice to complete the iron or steel hulls with skin-plating in the usual manner, and then to work wood planking outside the skin-plating in order to attach copper sheathing. A very large number of these sheathed ships are now employed in the Royal Navy and in foreign navies. The *Inconstant*, *Active*, and *Volage*, dating from 1868, are still on service, furnishing conclusive evidence of the durability of vessels of the class, and of the possibility of securing the anti-fouling properties of copper sheathing in association with the strength of iron or steel hulls. First cost is, of course, considerably higher than in unsheathed ships; and, although the wood sheathing adds greatly to the local strength of the bottoms, and somewhat to the general structural strength, as a rule the hull proper would be sufficiently strong without the wood. In other words, the extra cost and weight of the wood and copper sheathing and of the bronze castings usually employed in sheathed ships for stems, stern-posts, rudders, etc., must be regarded as the price paid for securing the maintenance of speed during long periods afloat, and the avoidance of frequent dockings and recoatings such as are necessary in unsheathed ships.

Many plans have been used for attaching the wood planking to sheathed ships. That generally employed in the Royal Navy until 1887 had the wood planking worked in two thicknesses. The inner thickness was secured to the skin-plating by iron screw-bolts, and the outer thickness to the inner by brass or yellow metal screw-bolts passing into but not through the inner planking. In this way it was hoped to avoid metallic connection between the copper sheathing and the skin-plating and bolts of the inner thickness of planking. The copper sheathing was not brought into contact with the metal stems, stern-posts, valves, etc., and every precaution was taken against galvanic action being set up which would lead to deterioration of the hull and fastenings. Experience shows that these arrangements have answered admirably with one exception. There has in no case been evidence of serious galvanic action or deterioration on the skin-plating. The fact that the copper sheathing has maintained its anti-fouling qualities confirms this conclusion. On the other hand, there have been many cases where the iron bolts securing the inner thickness of planking have wasted to a serious extent, owing to the presence of water between the planking and the skin-plating. The renewal of these bolts has been a costly and difficult matter, with two thicknesses of planking worked in the manner described. After full consideration, therefore, and in view of all experience gained, it has been decided to use only one thickness of planking in future sheathed ships of the Royal Navy, securing this to the steel skins by naval brass screw-bolts. Special arrangements are made to prevent the lodgment of water between the wood planking and the skin; and to avoid any local corrosion of the skin in the neighbourhood of the bolts. With these precautions there is no reason for anticipating galvanic action on the hull, and there can be no deterioration of the fastenings. Simplicity of attachment enables the planking to be readily removed for examination or repair of the hull; whereas with two thicknesses this is a troublesome matter. Experience with ships so sheathed as yet extends only over four or five years. So far as it has gone it has been entirely satisfactory, both as regards the preservation of the skin-plating and the anti-fouling qualities of the copper sheathing.

One special danger is necessarily incurred by all copper-sheathed iron or steel ships. Any damage to the bottom which stripped off the bottom planking and exposed a portion of the skin, might place that portion of the skin within the influence of powerful galvanic action; for it would be immersed in the same sea-water as the copper sheathing, be almost certainly in metallic connection therewith, and have concentrated upon its comparatively small area the

action of the very large surface of copper sheathing. The result might be very rapid corrosion of the skin, and possibly its perforation by holes. Such an accident, capable of stripping off wood planking firmly attached to the hull, must of course be exceptional in severity, and of very rare occurrence. The *Warspite*, sheathed with two thicknesses of wood and coppered, ran on the rocks in 1892, and seriously damaged her wood keels and some portions of the wood planking. In all such cases the least possible delay should be permitted in examining and repairing the damage, and if this is done no serious consequences can result.

Zinc sheathing has been tried instead of copper on a few iron ships in the Royal Navy, and on some iron ships in the mercantile marine. If it could have secured a fair degree of freedom from fouling, it would have been preferable, because its electrical relations to iron and steel would have prevented any galvanic action being set up causing the latter to suffer, and because first cost would have been lessened. At first promising results were obtained in the Royal Navy; but there is reason to believe that these were due in no small measure to the fact that the ship in which the trials were made was stationed for most of the year in the estuary of a river and in brackish water. Subsequently, on foreign service, the zinc sheathing of this ship became very foul when at sea, and was cleaned to a large extent when the vessel ascended rivers and entered fresh water. In another instance which came under the author's notice, a zinc-sheathed ship, belonging to a foreign navy, which had been several years afloat, and was found on docking to be remarkably clean, owed her condition in part, no doubt, to having been lying for some time before she was docked in comparatively fresh water. Taking experience with zinc-sheathed ships, as a whole it has been unfavourable, and the system has fallen into disuse. It appears that, after a very short period of immersion in sea-water, zinc becomes so rough on the surface as to largely increase frictional resistance. Cases have occurred where swift cruisers, zinc-sheathed, have performed their speed trials soon after being undocked with unsatisfactory results as compared with vessels of practically identical form, either copper-sheathed or with clean painted iron bottoms. In the relative roughness of the zinc surface was found the cause of the inferior performance. It has, therefore, become the custom to coat the bottoms of zinc-sheathed ships with anti-fouling compositions when they are docked. Zinc sheathing has, however, two advantages over unsheathed iron or steel skins: corrosion of the outer surface of the iron skin is rendered practically improbable by its presence. Further, when zinc-sheathed ships have been afloat for long periods, the fouling of their bottoms is, as a rule,

much less than that with bare iron. The vastly superior qualities of copper as an anti-fouler have led to its general use in the Royal Navy, and no zinc sheathing has been used for many years. It may, however, be found useful in stationary ships, or vessels of low speed.

Various plans have been tried for attaching zinc sheathing to iron hulls; that commonly used in the Royal Navy was as follows: A single thickness of planks (3-inch to 4-inch) was bolted outside the skin-plating; to this the zinc sheets were nailed: the strakes of planking were not caulked, but the water which found its way under the sheathing could pass freely through the seams to the iron skin. Iron stems and stern-posts were employed; and by various means a certain amount of metallic connection was made between the zinc and the iron hull, such connection being desirable in order to keep the surface of the zinc freer from incrustation. The practical difficulty was to adjust the relative amounts of the surfaces of iron and zinc, contributing to galvanic action on the latter, in such a manner as to prevent too rapid or too local wearing of the zinc without interfering with its anti-fouling properties. On wood ships zinc usually lasted for a considerable time, but was not very successful in preventing fouling; there it had but little metallic contact to produce galvanic action. On some merchant ships the zinc has been laid almost directly upon the iron skin, with felt or some similar material interposed, and its rate of wear has been so quickened that a single voyage has sufficed to destroy it.

Allusion has already been made to plans for constructing vessels with skin-plating which shall be practically incorrodible. In torpedo-boats and yachts, various bronzes and aluminium have been used. Proposals have been made also for using steel alloyed with such a percentage of nickel as would secure freedom from corrosion. With skins of this nature, not merely corrosion, but fouling, would no doubt be greatly diminished. On the other hand, first cost would be considerably increased as compared with ordinary mild steel skins; while the use of wood sheathing with copper attached probably involves less first cost, and makes a bottom capable of bearing rougher usage. It is by no means improbable, however, that as the cost of aluminium or that of nickel-steel alloys is lessened by improvements in manufacture, the use of non-corrodible skins may be more extended.

CHAPTER XI.

THE RESISTANCE OF SHIPS.

No branch of the theory of naval architecture has a richer literature than that which forms the subject of this chapter. It would be a formidable task merely to enumerate the names of eminent mathematicians and experimentalists who have endeavoured to discover the laws of the resistance which water offers to the progress of ships; and still more formidable would be any attempt to describe the very various theories that have been devised. Again and again has the discovery been announced of the "form of least resistance," but none of these has largely influenced the practical work of designing ships, nor can any be regarded as resting on a thoroughly scientific basis. In fact, a century and a half of almost continuous inquiry has firmly established the conviction that the problem is one which pure theory can never be expected to solve.

Although earlier theories of resistance are now discarded, and the present state of knowledge on the subject is confessedly imperfect, great advances have been made within the last half-century, and most valuable experimental data have been collected. The modern or "stream-line" theory of resistance may now be regarded as firmly established. Many eminent English mathematicians have been concerned in the introduction and development of this theory, as well as in the conduct of the experiments by which it has been put to the test. Of these two deserve special mention. The late Professor Rankine did much to develop the theory and practically apply it to calculations for the resistances and speeds of ships; the broad generalizations which we owe to him have served as guides to later investigators.* The late Mr. W. Froude was the founder of the modern system of model experiments, by which the resistances of full-sized ships may be determined. These experiments are carried on upon the basis of the stream-line theory of resistance,

* See div. i. chap. v. of *Shipbuilding, Theoretical and Practical*, edited by Professor Rankine.

and have fully confirmed its soundness. At the same time they have greatly enlarged, and in many particulars have corrected, the information previously possessed respecting the resistance of water to the movement of ship-shaped bodies. In addition to this important service, Mr. Froude did much to elucidate and popularize the stream-line theory. In fact, the best available descriptions of its great features are to be found in his published Lectures and Memoirs on the subject. Added to clear and masterly descriptions are the accounts of illustrative experiments; so that readers having but a moderate knowledge of mathematics can understand the principles involved and the practical deductions.* The experimental establishment founded by the late Mr. Froude, with assistance from the Admiralty, was conducted by him for some years. Since his death the superintendence of the establishment has been placed by the Admiralty in the hands of Mr. R. E. Froude, who has admirably continued and extended the investigations commenced by his father. This experimental establishment has become an important section of the Constructive Department of the Admiralty; and has proved of great value in designing modern war-ships of novel types and high speeds. A considerable amount of information of a general character obtained thereat, has been published, with Admiralty approval, chiefly in the *Transactions* of the Institution of Naval Architects. Similar experimental establishments have been created in Holland, Italy, and Russia, and one leading private shipbuilding firm in this country has done the same thing for the purposes of its own business. It is now generally recognized that only by direct experiment can the problems of resistance be certainly resolved. Possibly, as experimental data are accumulated, a fuller and more complete theory may be constructed.

Before attempting a brief outline of the stream-line theory of resistance, in general accordance with the methods followed by Rankine and Froude, it will be desirable to give a few explanations of terms that will be frequently employed.

Classification of Water-Resistance.—Water is not what is termed a *perfect* fluid; its particles do not move past one another with absolute freedom, but exercise a certain amount of rubbing or friction upon one another, and upon any solid body past which they move. Suppose a thin plate with a plane surface to be entirely immersed in water and moved end-on, or edgewise, it will experience what is termed *frictional* resistance from the water with which its surface comes into contact. The amount of this frictional resistance will

* See *Reports* of the British Association for 1875; and *Transactions* of the Institution of Naval Architects, vol. xv. and onwards.

depend upon the area and the length of the plate, as well as the degree of roughness of its surface and the speed of its motion. If this plate is moved in a direction at right angles to its surface, it encounters quite a different kind of resistance, termed *direct* or sometimes *head* resistance; this depends upon the area of the plate and the speed of its motion. Should the plate be moved obliquely, instead of at right angles to its surface, the resistance may be regarded as a compound of direct and frictional resistance. Supposing either direct or oblique motion to take place, the plate would leave an eddying "wake" behind it, as indicated somewhat roughly in Fig. 144, and the motion thus created amongst the particles con-

FIG. 144.

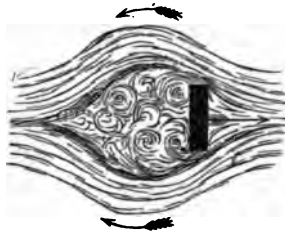

stitutes a very important element in their resistance to the passage of the plate. If the plate is not wholly immersed, or if its upper edge is near the surface, and it is moved directly or obliquely, it will heap up water in front as it advances, and create waves which will move away into the surrounding water as they are formed, and will be succeeded by others. Such wave-making requires the expenditure of

power, and constitutes a virtual increase to the resistance. If the plate were immersed very deeply, it would create little or no surface disturbance, and therefore require less force to propel it at a certain speed than would a plate of equal immersed area moving at the surface with a portion situated above that surface. If there were no surface disturbance, the resistance would be practically independent of the depth of immersion. This statement is directly opposed to the opinion frequently entertained, which confuses the greater *hydrostatical* pressure on the plate, due to its deeper immersion, with the dynamical conditions incidental to motion. It may, therefore, be desirable to add a brief explanation.

Supposing a deeply immersed plate to be at rest, the pressures on its front and back surfaces clearly must balance one another at any depth. When this plate is moved ahead at a uniform speed, it has at each instant to impart a certain amount of motion to the water disturbed by its passage; but the momentum thus produced is not influenced by the hydrostatical pressures on the plate, corresponding to the depth of its immersion. Water is practically incompressible; apart from surface disturbance, the volume of water, and therefore the weight, set in motion by the plate, will be nearly constant for all depths, at any assigned speed. In other words, if there be no surface disturbance, the resistance at any speed is independent of the depth. This is equally true of the resistance to direct and

oblique motion of a plate through water, as well as of frictional resistance, and the fact has been established experimentally. Colonel Beaufoy ascertained the resistances of a plate moving normally to itself, when submerged to depths of 3, 6, and 9 feet below the surface, and found them practically identical at all the depths. These experiments also served to establish the following very useful rule: The resistance per square foot of area sustained by a wholly submerged thin plate moving normally to itself through sea-water at a uniform speed of 10 feet per second is about 112 lbs.; and for other speeds the resistances vary as the squares of the speeds. Independent experiments made at the Admiralty works by Mr. R. E. Froude have practically confirmed Beaufoy's result, giving 109 lbs. as the resistance per square foot for the speed of 10 feet per second in sea-water.

The case where a thin plate is set obliquely to its line of motion is not so simple as that where it is at right angles. In Fig. 144 it will be noted that the stream-line motions are symmetrical, the water diverging and flowing over each edge of the plate, and obviously at the centre of the plate the water is at rest. A tow-line attached to the centre of the plate and extending forward in the direction of motion would therefore keep the plate normal to it, because the pressures on each side would be balanced. For oblique positions of the plate, it is equally true that the water must separate into two streams and escape over the edges; only in that case the intensity of the pressure on the foremost part (near the "leading" edge) of the plate will be much greater than that on the other part. That is to say, the line of zero-pressure on the plate where the streams may be supposed to diverge is nearer to the leading edge than to the after edge of the plate. This point is further discussed in Chapter XVIII., in connection with the action of water on rudders. For the present attention is directed chiefly to the laws which govern the total normal pressures on plates set obliquely to their line of motion, and it must be admitted that the existing state of knowledge is not satisfactory or complete.

It was formerly assumed that for an angle of obliquity α of a plate to its line of motion, the *normal* pressure thereon varied with the *square of the sine* of the angle of obliquity. For any speed—

$$\text{Oblique resistance (tow-rope tension)} = \text{direct resistance} \times \sin^3 \alpha.$$

Another theory, supposed to hold for small values of α , was that the normal pressure varied as the *sine of the angle* of obliquity; so that—

$$\text{Oblique resistance} = \text{direct resistance} \times \sin^2 \alpha.$$

Beaufoy made experiments for the purpose of determining the tensions on a tow-line, when a wholly submerged plate was set at

various angles to its line of motion and moved at various speeds. From the remarks of the experimentalist, it is evident that the results obtained were not regarded as entirely trustworthy, but it may be of interest to summarize them. This is done in the following table, where "resistances" indicate the tow-rope tensions in the line of motion. For oblique positions of the plate these tensions may be termed "oblique resistances," as distinguished from direct resistance when the plate is at right angles to the line of motion.

BEAUFOY'S EXPERIMENTS ON RESISTANCE OF SUBMERGED PLANE SURFACES.

Angles of plane with line of motion . . .	90°	80°	70°	60°	50°	40°	30°	20°	10°
Sines of angles . . .	1	·985	·940	·866	·766	·643	·5	·342	·174
(Sines) ² of angles . . .	1	·97	·88	·75	·587	·413	·25	·117	·03
(Sines) ³ of angles . . .	1	·96	·83	·65	·45	·26	·125	·04	·005
Resistance . . .	1·00	·915	·845	·828	·722	·579	—	·321	·272

It will be seen on investigation that Beaufoy's results do not agree with either of the formulæ which had been generally accepted; and it is known that the formulæ were not based upon a full consideration of the phenomena attending the flow of water past a plate.

M. Joëssel, of the French Navy, conducted a series of experiments on thin plates moving in water, with special reference to his plan of balanced rudder. Hence he deduced a formula for the *normal* pressure on a plate set at an angle α to its line of motion, which is probably one of the most trustworthy yet proposed. Let P = the direct resistance on a plate moving normally to itself at a certain speed; P_1 = the normal pressure when the plate is inclined at an angle α to the line of motion, and has the same speed of advance. Then M. Joëssel's formula is—

$$P_1 = \frac{\sin \alpha}{\cdot39 + \cdot61 \sin \alpha} \times P.$$

It will be seen that this formula gives ratios of P_1 to P considerably above those obtained by Beaufoy. At 20 degrees, for instance, Joëssel gives this ratio as ·57, and Beaufoy as ·32; at 40 degrees Joëssel gives ·82, and Beaufoy ·579; at 60 degrees Joëssel gives ·93, and Beaufoy ·828.

Lord Rayleigh has obtained, by mathematical reasoning and neglecting the effect of eddy-making at the back of a plate, a formula very similar to Joëssel's, viz.—

$$P_1 = \frac{2\pi \sin \alpha}{4 + \pi \sin \alpha} \times P = \frac{\sin \alpha}{\cdot637 + \cdot5 \sin \alpha} \times P.$$

Here the pressures P and P_1 are only those on the *advancing face* of the plate, and the solution does not profess to fully represent the conditions of practice.

Another interesting series of experiments has been made by Mr. Calvert, in connection with his inquiry into the best forms of screw-propellers.* The experiments were made on small solids, with plane front surfaces and convex backs, representing sections of the blades of screw propellers. The plane faces were set at various angles of obliquity to the line of motion, and the solids were moved at various speeds. Keeping the vertical measurements of the plates constant, their breadths were varied. Especial attention was bestowed on small angles of obliquity, from 13 degrees downwards. Although a very large number of experiments were made, and the method was most carefully studied in order to obtain trustworthy results, Mr. Calvert frankly admits that his conclusions are open to possible amendments if experiments were made on a larger scale, embracing a greater range of speeds. Even when thus limited those conclusions are of considerable interest. The most important are: (1) that the normal pressures were found to vary as the 1·85 power of the velocity, and not as the *square*; (2) that the pressures did not increase directly with increase in breadth, but at a less rate, the actual rate of increase varying for different angles of obliquity. If P is the normal pressure (in pounds) on the plane surface, of which B is the breadth and D the vertical measurement, Mr. Calvert gives the following empirical formula for velocity V in feet per second, and angle of obliquity a to the line of motion:—

$$P = 6 \times (V)^{1.85} \times B^m \times D \sin a.$$

m is a quantity to be determined by direct experiment; and Mr. Calvert graphically records values of m for all angles of obliquity up to 90 degrees, where it is unity. For less angles m diminishes in value, the diminution being very rapid for very small values of a . At 30 degrees m is said to be about ·6, at 13 degrees about ·4, at 8 degrees about ·32, and at 5 degrees about ·2. This formula will be seen to be similar to one of the earlier formulæ, in that the normal pressure on the plane face varies with the sine of the angle of obliquity. The variable function of the breadth used in estimating the pressure is entirely dependent upon the experiments, and these, as above stated, are not sufficiently extended to establish its correctness. There are, however, reasons for assuming that the conditions

* See the detailed account of the method of experiment and the results obtained appearing in the *Transactions* of the Institution of Naval Architects for 1887.

of the stream-line motions past an oblique plate may cause a sensible reduction in pressure on the after part.

Frictional Resistance.—Numerous experiments have been made to determine the *frictional* resistances of thin plates moved through water; the most valuable are those conducted by the late Mr. Froude for the Admiralty. Frictional resistance is measured by the momentum imparted in a unit of time to a current or “skin” of water which is then adjacent to the surface. This skin of water has a motion given to it in the direction of advance of the plate; while the particles within it move in frictional eddies. The extent to which the frictional resistance causes disturbance—that is to say, the “thickness of the skin”—varies with the velocity and other circumstances of the motion. From instant to instant the frictional current thus created is left behind by the moving surface, and a “frictional wake” is formed which follows the surface. The forward motion of this wake is gradually communicated to larger masses of water, its velocity is consequently decreased, and finally it ceases to be perceptible.* The momentum imparted to the water in a unit of time by a plate moving at a given speed is (as above explained) independent of the depth of immersion and the corresponding hydrostatical pressure on the plate, any small variations in the density of the water produced by changes in that depth being neglected. The governing conditions of the frictional resistance are, in short, the area and length of the plate, its degree of roughness, and the speed of advance.

Passing from these general considerations to the experiments on actual plane surfaces, made by Mr. Froude, the results were summarized by him in the following tabular statement and prefatory remarks.

MR. FROUDE'S EXPERIMENTS ON SURFACE-FRICTION.

This table represents the resistances per square foot due to various lengths of surface, of various qualities, when moving with a standard speed of 600 feet per minute, accompanied by figures denoting the power of the speed to which the resistances, if calculated for other speeds, must be taken as approximately proportional.

Under the figure denoting the length of surface in each case, are three columns, A, B, C, which are referenced as follows :—

- A. Power of speed to which resistance is approximately proportional.
- B. Resistance in pounds per square foot of a surface the length of which is that specified in the heading—taken as the mean resistance for the whole length.
- C. Resistance per square foot on unit of surface, at the distance sternward from the cutwater specified in the heading.

* See Mr. Froude's paper in the Report of the British Association for 1874.

Nature of surface.	Length of surface, or distance from cutwater, in feet.											
	2 feet.			8 feet.			20 feet.			50 feet.		
	A.	B.	C.	A.	B.	C.	A.	B.	C.	A.	B.	C.
Varnish	2·00	·41	·390	1·85	·325	·264	1·85	·278	·240	1·83	·250	·226
Paraffin	1·95	·38	·370	1·94	·314	·260	1·93	·271	·237	—	—	—
Tinfoil	2·16	·30	·295	1·99	·278	·263	1·90	·262	·244	1·83	·246	·232
Calico	1·93	·87	·725	1·92	·626	·504	1·89	·531	·447	1·87	·474	·423
Fine sand	2·00	·81	·690	2·00	·583	·450	2·00	·480	·384	2·06	·405	·337
Medium sand	2·00	·90	·730	2·00	·625	·488	2·00	·534	·465	2·00	·488	·456
Coarse sand	2·00	1·10	·880	2·00	·714	·520	2·00	·588	·490	—	—	—

NOTE.—Beaufoy's experiments made in the Greenland Docks (1794-98) gave values of A between 1·7 and 1·8, closely agreeing in this respect with the later experiments of Mr. Froude.

From these experiments the following deductions have been made. First, that the law formerly assumed to hold is very nearly conformed to ; the frictional resistance varying approximately as the *square of the velocity*, when the area, length, and condition of the surface remain unchanged. Second, that the *length* of the surface sensibly affects the mean resistance per square foot of wetted surface ; and especially when very short plates are compared with plates of 50 feet or upwards. Mr. Froude explains this important experimental fact as follows: "The portion of surface that goes first in the line "of motion, in experiencing resistance from the water, must in turn "communicate motion to the water in the direction in which it is "itself travelling ; consequently the portion of the surface which "succeeds the first will be rubbing, not against stationary water, but "against water partially moving in its own direction ; and cannot, "therefore, experience as much resistance from it." For greater lengths than 50 feet, it appears that the mean resistance per square foot of area remains nearly the same as for the plate 50 feet long.

A third important deduction is the great increase in frictional resistance which results from a very slight difference in the apparent roughness of the surface. For instance, the frictional resistance of a surface of unbleached calico—not a very rough surface—was shown to be about double that of a varnished surface. This varnished surface gave results just equal to a surface coated with smooth paint, tallow, or compositions such as are commonly used on the bottoms of iron ships. The frictional resistance of such a surface moving at a speed of 600 feet per minute would be about $\frac{1}{4}$ lb. per square foot, which would give a frictional resistance of about 1 lb. per square foot of immersed surface for the clean bottoms of iron ships when moving at a speed of about 12·8 knots. This unit is worth noting.

Mr. Calvert has experimented with a flat plank, 28 feet long, towed at different velocities on the surface of the water. By means of an ingenious system of pressure tubes projecting beneath the plank, he measured the velocity of the frictional wake at different points along the under-surface. At all speeds between 200 and 400 feet per minute, "the speeds recorded at distances of 1 foot, 7, 14, 21, and 28 feet from the leading end of the plank were respectively 16, 37, 45, 48, and 50 per cent. of the velocity of the plank." Proceeding further, Mr. Calvert investigated the changes in velocity in the water along a vertical line from the underside of the plank. At 28 feet from the leading end, 6 pressure tubes were arranged with their open ends at various depths, and their indications were simultaneously observed. The conclusion reached was, that "the velocity decreases in geometrical progression as the distance from the surface increases in arithmetical progression." At $\frac{7}{8}$ inch away from the under-surface, the velocity was *one-half* of the particles in contact with the surface, which were moving at half the velocity of the plank; at $1\frac{3}{4}$ inch, the velocity was one-fourth; at 5 to 6 inches away, the water was practically undisturbed. These results are unique and suggestive.

The foregoing remarks on the resistance experienced by plane surfaces moving through water will assist the reader in following the discussion of the more difficult problems connected with the resistances of ship-shaped solid bodies. In many of the earlier theories of resistance the immersed surface of a ship was assumed to be subdivided into a great number of pieces, each of very small area, and approximately plane. The angle of obliquity of each of these elementary planes with the line of advance of the ship—her keel-line—was ascertained; and its resistance was calculated exactly as if it were a detached plate moving along at the assumed speed. For quantitative purposes, experiments were to be made with small plates of known area moved at known speeds, and set at different angles of obliquity; the resistances being observed. But obviously there was a radical error in applying unit-forces of resistance, obtained from the movements of detached plates, to the case of a ship where all the hypothetical elementary plates were associated in the formation of a fair curved surface, and none of them could have that eddying wake (like that in Fig. 144) which necessarily accompanied each experimental plate and formed so important an element of its resistance. This objection does not apply to the experiments made under the auspices of the French Academy of Sciences, during the last century, by Bossut, Condorcet, D'Alembert, Romme, and others; these experiments having been directed to the discovery of the resistances experienced by *solid bodies* of various forms moved at different

depths. Very few of the models tried, however, had any pretension to ship-shaped forms; and this is also true of the subsequent experiments made in this country by Beaufoy.

Satisfactory experiments on the resistances of ships can alone be made with ship-shaped models of reasonable dimensions. This is the principle upon which Mr. Froude proceeded in his experiments. Doubts were expressed at first respecting the correctness of the results deduced from models when applied to full-sized ships, but the experience of twenty years has thoroughly established the system.

Stream-line Theory of Resistance.—The modern theory of resistance does not make any hypothetical subdivision of the immersed surface of a ship, but regards it as a whole. When such a surface, with its fair and comparatively gentle curves (like those in Fig. 145), is submerged and drawn through water, the particles are diverted laterally, and can glide over or past the ship without sudden or abrupt changes of motion, corresponding to those which occur when particles escape over the edge of the plate in Fig. 144. The paths of the particles are indicated roughly in Fig. 145 by the curved lines, the ship-shaped body being shown in black. After passing the broadest part of the vessel, the particles close in over the after part, and, gliding over the continuous surface, form a wake astern.

FIG. 145.

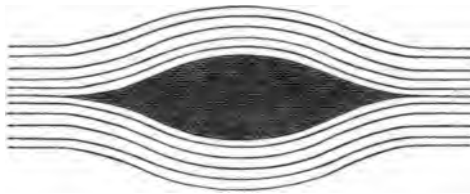

In the modern theory, the total resistance is considered to be made up of three principal parts: (1) frictional resistance, due to the gliding of particles over the rough bottom of the ship; (2) "eddy-making" resistance, which occurs chiefly at the stern; (3) surface disturbance, or wave-making resistance. The second of these divisions only acquires importance in exceptional cases; it is known to be very small in well-formed ships. It will, therefore, be necessary to bestow most attention upon frictional and wave-making resistance, to examine the conditions governing each, and to contrast their relative importance. It will be assumed throughout that the ship is either dragged or driven ahead at uniform speed by some external force which does not affect the flow of the water relatively to her sides. This is the condition always assumed when the *resistance* of a ship is being treated. It is advantageous to separate propulsion from resistance, since the latter depends in all ships only upon the form, proportions, and condition of the bottom; whereas there are many means of propelling ships.

Suppose the ship to be moving ahead at uniform speed through an ocean unlimited in extent and depth, and motionless except for the disturbance produced by the passage of the ship. Under the conditions assumed, there will obviously be no change in the *relative* motions of the ship and the water if she is supposed to remain fixed, while the ocean flows past her at a speed equal to her own, but in the opposite direction to that in which the ship really moves. This alternative supposition has the advantage of enabling one to trace more simply the character of the disturbances produced by introducing the solid hull of the ship at a certain speed into water which was previously undisturbed. First, let the water be assumed to be *frictionless*, and the bottom of the ship to be perfectly *smooth*. These are only hypothetical conditions, but it is possible at a latter stage of the inquiry to introduce the corrections necessary to represent the actual conditions of practice. Take any set of particles situated a long distance before the ship, and moving in a line parallel to her keel. If the ship were not immersed in the ocean current, these particles would continue to move on in the same straight line, which would be horizontal. When the ship is immersed her influence upon the motion of the particles may extend to a very long distance ahead, but there will be some limit beyond which the influence practically does not extend, and outside this, the particles whose motion is being traced will be moving at a steady speed in a horizontal line parallel to the keel. As they approach the ship, however, their path must be diverted in order that they may pass her; and this diversion will be accompanied by a change in their speed. Supposing, for the sake of simplicity, that the particles maintain the horizontality of their motion, and are only diverted laterally; then, as they approach the bow of the ship, they will move out sideways from the keel-line, and lose in their speed of advance. Many considerations must govern the extent of this lateral diversion and loss of speed; such as the form of the bow, the extreme breadth of the ship, and the athwartship distance from the line of the keel of the original line of flow of the particles. At the broadest part of the ship amidships the velocity of the particles of water must be greatest, because the breadths of the "streams" in which they flow are there less than at the bow, and the same quantity of water has to pass the two places. After the midship part of the ship has been passed, and her breadth begins to decrease, the path of the particles will converge towards the keel-line; and their speed will again receive a check. Finally, after flowing past the ship, and attaining such a distance astern as places them beyond the disturbing influence of the ship, the particles will regain their original direction and speed of flow, provided that there is *no surface*

disturbance. This last-mentioned condition could only be fulfilled in the case of a vessel wholly immersed, at a great depth, below the surface of an ocean limitless in depth; in the case of ships which are only partly immersed, the retardations and accelerations described must cause the formation of bow and stern waves, and these will be considered hereafter.

Although it has been assumed, for the sake of simplicity, in the foregoing remarks that the particles maintain their horizontality of flow, it should be understood that the assumption is not supposed to represent the actual motion of the water in passing a ship. Diversion from the original line of flow is almost certain to have a vertical as well as a lateral component; but as to the paths actually traversed by particles, we have little exact knowledge. Mr. Scott Russell was of opinion that at the foremost part of a ship the particles moved in layers which were almost horizontal; while at the stern the particles had a considerable vertical component in their motion, besides converging laterally. Professor Rankine asserted that "the actual paths of the particles of water in gliding over the bottom of a vessel are neither horizontal water-lines nor vertical buttock-lines but are intermediate in position between those lines, and approximate in well-shaped vessels to the lines of shortest distance, such as are followed by an originally straight strake of plank, when bent to fit the shape of the vessel." But, whatever paths may be followed, if at a considerable distance astern of a ship, wholly submerged in a frictionless fluid, the particles have regained their original direction and speed of flow, which they had at a considerable distance ahead of the ship, then their flow past the ship will impress no end-wise motion upon her.

Professor Rankine laid down geometrical rules for constructing the paths, or "stream-lines," along which the particles of a frictionless fluid would flow in passing a body very deeply submerged, supposing the particles to move in plane layers of uniform thickness. Fig. 146 was constructed by Mr. Froude in accordance with these rules.* The form of the immersed body with its comparatively blunt bow and stern is indicated in black; the curved lines indicate the paths of particles. Between any two of these stream-lines, the same particles would be found throughout the motion, and these would form a "stream" of which the stream-lines mark the boundaries. It will be noted that, as the streams approach the bow, they broaden, their speed being checked, and the particles diverted laterally; the

* See the address to the Mechanical Section of the British Association in 1875. Professor Rankine's method is

described at pp. 106, 107 of "Shipbuilding, Theoretical and Practical."

amount of this diversion decreases as the athwartship distance of the stream from the keel-line increases, and at some distance athwartship the departure of the stream-lines from parallelism with the keel, even

FIG. 146.

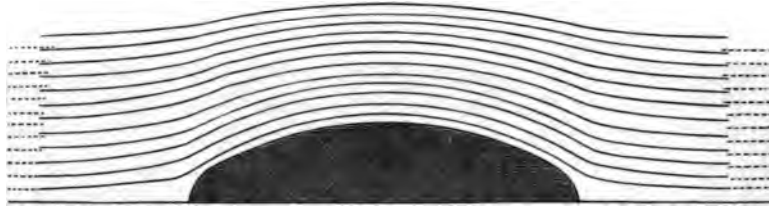

when passing the ship, would be very slight indeed. As the streams move aft from the bow, they become narrowed, having their minimum breadth amidships, where the speed of flow is a maximum. Thence, on to the stern, the streams converge, broaden, lose in speed, and finally at some distance astern resume their initial direction and speed. Since there is no friction, there can be no eddying wake.

So much for a vessel wholly submerged; a ship only partly immersed would be differently situated, because even in a frictionless fluid she would produce surface disturbance. At the bow, where the streams broaden and move more slowly, a wave crest will be formed, of the character shown in Fig. 147; amidships, where the conditions

FIG. 147.



are reversed, some depression below the normal water line may occur; and at the stern, where the conditions resemble those forward, another wave crest will be formed. Between the bow and stern waves a train of waves may also exist, under certain circumstances. The existence of such waves, when actual ships are driven through the water, is a well-known fact; every one readily sees why, at the bow, water should be heaped up and a wave formed, but the existence of the stern wave is more difficult to understand. As remarked above, there is but one reason for both phenomena. A check to the motion of the particles is accompanied by an increase of pressure; the pressure of the atmosphere above the water is practically constant, and hence the increase of pressure in the water must produce an elevation above the normal level, that is to say, a wave crest. Conversely, amidships, accelerated motion is accompanied by a diminution of pressure, and there is a fall of the water-surface below the still-water level, unless the intermediate train of waves should somewhat modify the conditions of the stream-line motion.

These waves require the expenditure of force for their creation, and, when formed, they may travel away into the surrounding fluid, new waves in the series being created. In the case, therefore, of a ship moving at the surface of frictionless water, the only resistance to be overcome will be that due to surface disturbance. For the wholly submerged body which creates no waves there will be no resistance, when once the motion has been made uniform; the stream-lines, once established in a frictionless fluid, will maintain their motion without further expenditure of power.

This remarkable result follows directly from a general principle which is thus stated by Professor Rankine: "When a stream of water has its motion modified in passing a solid body, and returns exactly to its original velocity and direction of motion before ceasing to act on the solid body, it exerts on the whole no resultant force on the solid body, because there is no permanent change of its momentum." In every stream surrounding the submerged body in Fig. 146, this has been shown to hold; each stream regains its initial direction and velocity astern of the body. The partially immersed ship in the frictionless water differs from the submerged ship in producing surface disturbance.

Perhaps the general principle will be better understood from one of Mr. Froude's simple and beautiful illustrations. Taking a perfectly smooth bent pipe (Fig. 148), he supposed it to be shaped

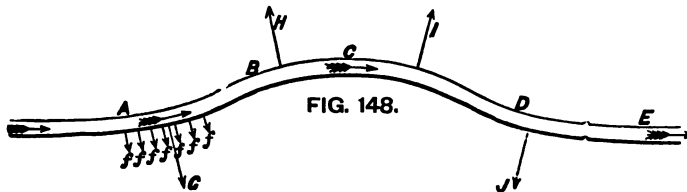

symmetrically, and divided it into four equal and similar lengths AB, BC, CD, DE. The ends of the pipe at A and E are in the same straight line; a stream of frictionless fluid flows through it, and has uniform speed throughout. From A to B may be supposed to correspond to the forward part of the entrance of a ship, where the particles have to be diverted laterally, and react upon the inner surface of the pipe, as indicated by the small arrows *f, f, f*, the resultant of these normal forces being G. At the other end of the pipe, from D to E may be taken to represent the "run" of a ship, where the stream lines are converging and tending to resume their original directions; on DE there will be a resultant force J equal to G. Similarly, the resultant forces on the other two parts BC and CD are equal. The final result is that the four forces exactly neutralize one another, and there is no tendency to force the pipe on

in the direction of the straight line joining A to E, although at first sight it would appear otherwise. The same thing will be true if, instead of being uniform in section, the pipe is of varying size, and if, instead of being symmetrical in form, it is not so; provided only that at the end E the fluid resumes the velocity it had at A, and flows out in the same direction. The forces required to produce any intervening changes in velocity and direction must have mutually balanced or neutralized one another, as in the preceding example, before the stream could have returned to its original velocity and direction of motion.

Applying these principles to the stream-lines surrounding a ship, it will be possible to remove one or two difficulties which have given rise to erroneous conceptions. It has been supposed, for example, that a ship in motion had to exert considerable force in order to draw in the water behind her as she advanced. As a matter of fact, however, the after part of a ship has not to exercise "suction" at the expense of an increased resistance, but sustains a considerable forward pressure from the fluid in the streams closing in around the stern. Any cause which prevents this natural motion of the streams, and reduces their forward pressure on the stern—such as the action of a screw propeller—causes a considerable increase in the resistance, because the backward pressures on the bow are not then so nearly balanced by the forward pressures on the stern. Again, it will be evident that—apart from its influence on surface disturbance—the extent of the lateral diversion of the streams, in order that they may pass the midship part of the ship, does not affect the resistance so much as might be supposed; since the work done on the foremost part of the ship in producing these divergencies is, so to speak, given back again on the after part where the streams converge. Very considerable importance attaches, however, to the lengths at the bow and stern over which the retardations of the particles extend; since these lengths exercise considerable influence upon the lengths of the bow and stern waves created by the motion of the ship. And further, the ratios of these lengths of entrance and run to the extreme breadth of the ship must be important, as well as the curvilinear forms of the bow and stern, since the extent to which the particles are retarded in gliding past the ship must be largely influenced by these features; and, as we have seen, the heights of the waves will depend upon the maximum values of the retardations. In other words, with the same lengths of entrance and run, differences in the "fineness" of form at the bow and stern may cause great differences in the heights of the waves created, and consequently in the energy required to create and maintain such waves.

Frictional and Eddy-making Resistance of Ships.—Such are the

principal features of the stream-line theory of resistance for frictionless fluids and smooth-bottomed ships. The sketch has been necessarily imperfect, but it will serve as an introduction to the more important practical case of the motions of actual ships through water. Between the hypothetical and actual cases there are certain important differences. First, and by far the most important, is the frictional resistance of the particles of water which glide over the bottom; secondly, friction of the particles on one another in association with certain forms, especially at the sterns of ships, may produce considerable eddy-making resistance, although this is not a common case; thirdly, friction may so modify the stream-line motions as to alter the forms of the waves created by the motion of the ship, and somewhat increase the resistance.

First, as to *frictional* resistance. Its magnitude depends upon the area of the immersed surface of the ship, upon the degree of roughness of that surface, or its "coefficient of friction," upon the length of the surface, and upon the velocity with which the particles glide over the surface. From what has been said above, it will appear that this velocity of gliding varies at different parts of the bottom of a ship, being slower at the bow and stern than it is amidships. Professor Rankine endeavoured to establish a simple formula for computing the resistances of ships when moving at speeds for which their proportions and figures are well adapted. Under these circumstances he considered that "the whole of the appreciable resistance" would result from the formation of frictional eddies: in other words, that the wave-making factor in the resistance might be neglected. It is now known that this assumption was not a true one except for moderate speeds; whereas it was applied by Rankine to considerable speeds. On the other hand, his method of approximating to the frictional resistance and attempt to allow for variations in the velocities of gliding of the particles over the surface may still be studied with advantage. Rankine supposed that the wetted surface of a ship could be fairly compared with the surface of a trochoidal riband having the following properties:—(1) the same coefficient of friction as the bottom of the ship; (2) the same length as the ship; (3) a uniform breadth equal to the mean girth of transverse sections of the wetted surface; (4) an inflexional tangent, making an angle with the base of the trochoid, of which the value was to be deduced from a process of averages applied to the squares and fourth powers of the *sines* of the angles of greatest obliquity of the several water-lines in the fore body. For any trochoidal riband in which the angle made by the inflexional tangent with the base

... of the ...

... of the ...

... of the ...

... of the ...

... of the ...

... of the ...

... of the ...

... of the ...

... of the ...

... of the ...

... of the ...

... of the ...

... of the ...

... of the ...

... of the ...

... of the ...

... of the ...

... of the ...

... of the ...

... of the ...

... of the ...

... of the ...

... of the ...

... of the ...

... of the ...

... of the ...

... of the ...

... of the ...

... of the ...

... of the ...

... of the ...

... of the ...

... of the ...

... of the ...

... of the ...

will have the same frictional resistance for the same speed; but they are likely to have different total resistances. The influence of form and proportion is greatest at high speeds, and it is chiefly felt in the direction of surface disturbance or wave-making; eddy-making or wake formation also depends upon form, especially at the stern.

The remarks made above respecting the general character of frictional resistances to the motion of planes, apply also to the case of the curved wetted surfaces of ships; and, from an inspection of the coefficients of friction previously given, it is easy to see why foulness of bottom often causes a considerable reduction in the speed of ships. Furthermore, in comparing the frictional resistances of a small model and a full-sized ship, it is necessary to make the necessary corrections in the coefficients of friction on account of differences in length. Such corrections always appear in the records of model experiments.

Model experiments have determined the actual value and the relative importance of frictional resistance in different classes of ships moving at various speeds. In all well-formed ships moving at moderate speeds a very large proportion of the total resistance is due to friction. At speeds of 6 to 8 knots, for example, with clean bottoms, frictional resistance has been found to represent from 80 to 90 per cent. of the total resistance. At full speeds in ships steaming at high speeds—18 to 22 knots—friction has a less proportionate effect, but still represents from 45 to 60 per cent. of the total resistance. When the bottoms become foul, and the coefficients of friction are doubled or trebled as compared with clean bottoms, frictional resistance assumes greater relative importance. For a given speed a much larger expenditure of power and coal is required; and for a given development of power there is a more or less serious loss of speed according to the degree of foulness.

Second, as to *eddy-making* resistance. It is generally agreed that in well-formed ships with easy curves at the entrance and run (more particularly the latter), this factor in the resistance is comparatively unimportant. Experiments indicate that eddy-making ordinarily bears a fairly definite proportion to frictional resistance; and Mr. Froude estimated eight per cent. of the frictional resistance as a fair allowance for eddy-making in a well-formed ship, when (to revert to our old illustration) the stream-lines in a frictionless fluid would converge easily towards the stern, and have regained very nearly their original velocities and directions before they leave the ship. With a full stern, and abrupt instead of gently curved terminations to the water-lines of a ship, the particles of water cease to act upon her at a period when they still retain a considerable forward velocity; and the momentum thus created, and not given back in forward pressure on the stern, is a virtual increase to the resistance.

was ϕ , Rankine had previously obtained the following expression for the resistance due to frictional eddies.

$$\text{Resistance} = \text{length} \times \text{breadth} \times \text{coefficient of friction} \\ \times (\text{speed})^2 \times (1 + 4 \sin^2 \phi + \sin^4 \phi).$$

The last term was styled the "coefficient of augmentation." Hence

$$\text{Resistance} = \text{coefficient of friction} \times (\text{speed})^2 \\ \times \text{"augmented surface."}$$

And his supposition was that for ships of good forms a similar expression would hold, within the limits of speed usually attained. For clean-painted iron ships the formula was very simply stated:—

$$\text{Resistance} = \text{length} \times \text{mean girth of wetted surface} \times \text{coefficient} \\ \text{of augmentation} \times (\text{speed in knots})^2 \div 100 \\ = \frac{\text{augmented surface} \times (\text{speed in knots})^2}{100}$$

This method of estimating the probable resistances of ships has been extensively employed by some shipbuilders, and is undoubtedly of use when the speeds to be attained are comparatively moderate. As the speeds increase, and the wave-making resistance assumes importance, the method necessarily fails; the total resistance then varies with a higher power of speed.

Mr. Froude investigated the frictional resistances of ship-shaped models, and as the result of a series of experiments came to a conclusion which greatly simplifies the calculation of this important factor, viz. that no sensible error is involved in calculating the frictional resistance "upon the hypothesis that the immersed skin is equivalent to that of a rectangular surface of equal area, and of length (in the line of motion) equal to that of the model, moving at the same speed." Hence, it is only necessary to experiment with such a plane surface as will enable the proper coefficient of friction to be found, then to measure the immersed surface of the ship, and to apply the coefficient, neglecting the variations in speed of the particles at different parts of the surface.

It has been suggested that this generalization requires further and more extended experimental verification before it can be accepted absolutely, especially for ships of great length. No doubt further experiments on planes and curved surfaces of greater length moved at higher speeds would be valuable, but they involve considerable difficulties in execution.

This method of estimating the frictional resistance on the immersed surface of a ship obviously takes no account whatever of the *forms* and *proportions* of ships. Two ships of very different forms, but of equal area of bottom, equal roughness, and equal length,

will have the same frictional resistance for the same speed; but they are likely to have different total resistances. The influence of form and proportion is greatest at high speeds, and it is chiefly felt in the direction of surface disturbance or wave-making; eddy-making or wake formation also depends upon form, especially at the stern.

The remarks made above respecting the general character of frictional resistances to the motion of planes, apply also to the case of the curved wetted surfaces of ships; and, from an inspection of the coefficients of friction previously given, it is easy to see why foulness of bottom often causes a considerable reduction in the speed of ships. Furthermore, in comparing the frictional resistances of a small model and a full-sized ship, it is necessary to make the necessary corrections in the coefficients of friction on account of differences in length. Such corrections always appear in the records of model experiments.

Model experiments have determined the actual value and the relative importance of frictional resistance in different classes of ships moving at various speeds. In all well-formed ships moving at moderate speeds a very large proportion of the total resistance is due to friction. At speeds of 6 to 8 knots, for example, with clean bottoms, frictional resistance has been found to represent from 80 to 90 per cent. of the total resistance. At full speeds in ships steaming at high speeds—18 to 22 knots—friction has a less proportionate effect, but still represents from 45 to 60 per cent. of the total resistance. When the bottoms become foul, and the coefficients of friction are doubled or trebled as compared with clean bottoms, frictional resistance assumes greater relative importance. For a given speed a much larger expenditure of power and coal is required; and for a given development of power there is a more or less serious loss of speed according to the degree of foulness.

Second, as to *eddy-making* resistance. It is generally agreed that in well-formed ships with easy curves at the entrance and run (more particularly the latter), this factor in the resistance is comparatively unimportant. Experiments indicate that eddy-making ordinarily bears a fairly definite proportion to frictional resistance; and Mr. Froude estimated eight per cent. of the frictional resistance as a fair allowance for eddy-making in a well-formed ship, when (to revert to our old illustration) the stream-lines in a frictionless fluid would converge easily towards the stern, and have regained very nearly their original velocities and directions before they leave the ship. With a full stern, and abrupt instead of gently curved terminations to the water-lines of a ship, the particles of water cease to act upon her at a period when they still retain a considerable forward velocity; and the momentum thus created, and not given back in forward pressure on the stern, is a virtual increase to the resistance.

Behind the stern of such a vessel will lie a mass of so-called "dead-water," an eddying wake like that behind the plate in Fig. 144. Such a form of stern is objectionable, and is never adopted unless its use is unavoidable in order to fulfil other and more important conditions than those affecting the resistance. It not merely increases resistance, but reduces the efficiency of propellers placed behind it.

In order to diminish eddy-making resistance as much as possible, careful attention must be given to the forms of the various adjuncts to a ship, as well as to the shape of the ship herself. Outlying pieces—such as stern-posts, rudders, struts to shaft-tubes in twin-screw ships, supports to sponsons in paddle-steamers, etc.—may occasion a sensible increase to the total resistance if improperly shaped. No general rule can be laid down in this matter; but Mr. Froude pithily expressed an important fact when he said, "It is "blunt tails rather than blunt noses that cause eddies." In other words, the after terminations of outlying parts should be made as fine as possible consistently with other requirements.

Characteristics of the "Wake" of Ships.—When ships are well formed, and eddy-making is reduced to a minimum, their motion through water is necessarily accompanied by a "wake," in which the water near to the stern has a forward motion impressed upon it. One of the main causes of this wake is frictional resistance, and the explanations given above for plane surfaces apply also to ship-shaped forms. The stream-line motions, and at certain speeds the waves produced by the advance of a ship, also influence the motion of particles in the wake. Certain general principles have long been recognized in relation to the movement of water in the wake of a ship which is towed. For example, it is agreed that the maximum forward velocity is likely to occur in particles which flow past the fuller portions of the stern at and near the water-line; while much less velocity is impressed on particles which flow over the fine deadwood. Further, it is obvious that there must be a gradual loss of forward velocity with increase in the athwartship distance of particles from the hull, at any assigned depth below the surface. Variations of velocity must also occur with change in the longitudinal positions of particles, especially after the ship has passed clear ahead of them. In connection with experimental and analytical investigations into the efficiency of screw propellers, this problem of the wake has assumed greater importance, and has been more thoroughly investigated.* A large amount of informa-

* See papers in the *Transactions of the Institution of Naval Architects*; by the late Mr. Griffiths in 1879; by Mr. R. E. Froude in 1883 and 1886; and by Mr. Calvert in 1893.

tion has been obtained from model experiments, and much has been learnt from careful observations of the performances of ships. Naturally most attention has been given to the phenomena of those portions of the wake which affect the action of screw propellers, and are comparatively close to the stern.

Valuable and extensive observations of this kind were made in 1891 by Mr. Calvert. A boat $28\frac{1}{2}$ feet long and 3 feet 8 inches in beam was towed in smooth water at various speeds; the towing appliances were fixed, and the screw was not in place. By means of a number of ingenious pressure-logs, the velocities of the streams at different points were measured by the heights of water in tubes. Photographic records were taken of these heights, and simultaneous values for different tubes obtained. The pressure-logs were free to turn both horizontally and vertically, and thus it was endeavoured to indicate the direction as well as the velocity of flow relatively to the ship. Measurements of this kind were made at a great many positions in the water surrounding the stern, and great care was taken to ensure accuracy. Apart from any claim to absolute accuracy, the great number of observations and their general agreement make the results specially interesting and important. Graphic and tabulated records have been based on these experiments, which show admirably the velocities and directions of the "stream-lines" surrounding the stern of the experimental boat. These charts may be subject to some correction, but they give information such as has not been previously available for the whole region in which the screw-propeller would have to work. From them it appears that at a speed of 460 feet per minute, or 4.6 knots per hour, the experimental boat had a wake the particles of which, at some points close to the stern and near the water-line, had a forward velocity exceeding 60 per cent. of the velocity of the boat. This was no doubt in the frictional wake; and a few feet athwartships away from the points where these high velocities were measured, the corresponding velocity was not more than 10 per cent. As the depths below the water-surface increased, and the streams flowed over the finer portions of the dead-wood, the forward velocity rapidly diminished and fell to not more than one-fourth that near the surface. These are but samples of the results which we owe to Mr. Calvert, whose work is likely to lead to similar investigations by other experimentalists.

Although the motion of water in the wake varies so greatly, it has been shown, by means of a large number of model experiments, that in considering the action and efficiency of screw-propellers the wake may be assumed to be a current of uniform velocity, so far as the sectional area is concerned which influences the thrust and

slip of the propeller.* This mean velocity of the wake is usually expressed as a percentage of the speed of the ship, and termed the "wake percentage." For single-screw ships the propeller operates on a portion of the wake, where (as will be obvious from the foregoing remarks) the forward velocity should be greatest. The wake percentage for such vessels has been found to vary from 20 to 30. In twin-screw ships the propellers are carried at more or less considerable distances from the hull, both in the athwartship and the longitudinal directions. With full forms of sterns and twin-screws the wake percentage has been found to vary from 14 to 17, and with fine forms, with propellers well clear of the hull, it has fallen as low as 5 to 10. This matter will be again referred to in Chapter XVI. when dealing with the efficiency of screw-propellers.

Wave-making Resistance.—The general character of the causes which create waves at the bows and sterns of ships moving in a frictionless fluid have already been sketched. Similar causes operate when the motion takes place in water, although the friction of the particles against each other and against the surface of the ship affect both the dimensions and positions of the waves. At the bow and stern, the motion of the particles of water relative to the ship has its minimum, and there are wave crests; amidships the relative motion has its maximum speed, and there may be a wave hollow. In other words, considering the ship as in motion and the water as motionless except for the motion she impresses upon it, the particles of water at the bow and stern will have motion in the same direction as the ship; those amidships will have motion in the opposite direction. Besides these two principal wave crests at the bow and stern, there may be other minor waves created, the general principle being that wherever a crest is formed the particles attain a maximum speed in the direction of the advance of the ship; and where a hollow is formed the particles have a maximum speed in the opposite direction. The principal waves at the bow and stern are each followed by a train of waves, successive waves in the series having diminished heights.

It will be remembered that throughout this discussion no propeller is supposed to be in action, which could modify the relative motions of the water and the ship. But it is worth notice that the action of propellers may create additional wave crests, or modify considerably those formed by the ship. Paddle-wheels, for example, placed nearly amidships, accelerate the sternward

* See on this point papers by Mr. the Institution of Naval Architects for R. E. Froude, in the *Transactions* of 1883 and 1886.

motion of particles, and produce an additional wave. Screw-propellers, on the contrary, being placed aft, give sternward motion to the particles, and tend to degrade the stern wave, as well as to cause considerably greater resistance by partially destroying the forward pressure of the water upon the stern; but they also create a local upheaval of the water, and confuse the phenomena of the waves.

The laws which govern the wave-making resistance of ships are not yet fully understood, systematic investigation of the subject having been begun within the last half-century. Mr. Scott-Russell was one of the earliest workers in this field, and made a large number of experiments, chiefly upon canal boats and small vessels, before putting forward his well-known "wave-line" theory of constructing ships. The theory is not in complete accordance with more recent investigations, but it has the great merit of having enforced the importance which attaches to the wave-making factor in the resistance, unless the lengths of "entrance" and "run" in a ship are suitably proportioned to her intended maximum speed. By the "entrance" is meant that part of the ship bounded by the stem and by the foremost athwartship section which has the full dimensions of the midship section; the "run" is the corresponding length at the stern; and the "middle body" or "straight of breadth," is that part of a ship amidships where the cross-sections maintain the form of the midship section. The entrance and run have also been termed the "wave-making features," because the waves which accompany a ship are produced, as we have seen, by the accelerations and retardations of the particles of water resulting from the motion of the entrance and run relatively to those particles. It is obvious, on reflection, that the *lengths* as well as the *forms* of entrance and run must greatly influence both the bow and the stern waves. During each interval occupied by a ship in advancing through a distance equal to the length of her entrance the sets of particles then contiguous thereto undergo accelerations which lead to the production of the bow-wave; and this interval of time depends upon the ratio of the length of entrance to the speed of the ship. Similarly, importance must attach to the ratio of the length of the run to the speed. If a ship is formed so that these ratios are suitably adjusted for the maximum speed she is destined to attain, and the curves of the bow and stern are easy and fair, the wave-making resistance will not assume undue importance. When such a ship has reached her uniform speed, and the waves have been fully formed, the maintenance of those waves will require a certain expenditure of force which measures the wave-making resistance. The case is parallel to that of the deep-sea waves (described at p.

219), which travel over immense distances without any great loss of speed; but with this important difference, that, whereas the ocean-waves gradually become degraded, the waves accompanying ships, under the favourable conditions described, are kept to their full heights.

If the lengths of entrance and run are not suitably adjusted to the maximum speed of the ship, the waves which are formed, or a certain portion of them, diverge from her path, carrying off into still water the energy impressed upon them. The ship has, therefore, to be continually creating new waves, and the expenditure of force involved in this creation may form a very serious feature of the total resistance. Moreover, when the speed of a ship exceeds that of the waves which her entrance and run naturally tend to form, other series of waves make their appearance, even more important than the diverging waves, and requiring a very large expenditure of power for their maintenance. These waves have a length proportioned to the speed of the ship, and actually keep pace with her; although the wave-making features of the ship are not adapted to their formation on account of the inadequate lengths of entrance and run.

It is now universally admitted that for every vessel there is a certain limit beyond which increased speed can only be secured at the expense of a very rapid growth in resistance. This limit is "somewhat less than that appropriate to the length of the wave which the ship tends to form," which length obviously bears a close relation to the length of entrance and run.* This general endorsement of a principle first enunciated by Mr. Scott-Russell naturally leads to a closer consideration of his wave-line theory.

According to this theory the water displaced by the bow of a ship forms a "solitary" wave, wholly situated above the level of still water, and travelling as a heap of water. This bow wave is sometimes styled the "wave of displacement," and its companion stern wave is named the "wave of replacement." The latter wave Mr. Russell supposed to be the leading wave in a trochoidal series resembling the deep-sea waves described in Chapter V. In order to prevent undue wave-making, the theory prescribed that the length of entrance given to a ship should be at least equal to the length of the solitary wave having a natural speed equal to the maximum speed proposed for the ship; and the length of run should be two-thirds the length of the entrance. Rules were also laid down for

* The apparent exceptions to the foregoing statement furnished by torpedo-boats and swift launches are discussed hereafter.

guidance in designing the forms of the entrance and run, so that the resistance might be minimized.*

The rules of Mr. Scott-Russell for lengths of entrance and run may be stated in the following simple form: Let V be the maximum speed of the ship (in knots per hour); L_1 be the length of entrance appropriate to the speed V , and L_2 the length of run (both lengths being expressed in feet); then—

$$\begin{aligned} L_1 &= 0.562 \times V^2, \\ L_2 &= 0.375 \times V^2 = \frac{2}{3} L_1. \end{aligned}$$

For example, let $V = 15$ knots; then, to avoid undue wave-making, the theory prescribes—

$$\begin{aligned} \text{Length of entrance} &= 0.562 \times 15^2 = 126 \text{ feet;} \\ \text{Length of run} &= 0.375 \times 15^2 = 84 \text{ feet.} \end{aligned}$$

With these dimensions Mr. Scott-Russell considered there might be associated any required length of middle body, the additional resistance for the assigned speed being chiefly due to friction on the enlarged immersed surface.†

Of these two rules, that relating to the length of run was thought to have the greatest practical importance, many successful vessels having had a less length of entrance than that prescribed by the formula; whereas vessels with shorter runs than the formula prescribes have done badly. As a matter of fact, however, seagoing vessels usually have greater lengths both of entrance and run, in proportion to their maximum speeds, than are required by these rules; and instead of having the run only two-thirds as long as the entrance, the lengths of entrance and run are commonly equal, or nearly so.

It will be observed from the preceding formula that—

$$L_1 + L_2 = 0.937 V^2;$$

whence—

$$V^2 = 1.067(L_1 + L_2); \text{ and } V = 1.03\sqrt{L_1 + L_2} \text{ (nearly).}$$

So far as can be seen at present, this last equation enables a fair approximation to be made to the speed (V) at which a small increase in speed causes an increase in resistance altogether disproportionate to that which would accompany an equal increase in speed when the vessel was moving more slowly. Putting the equation in this form allows for any variations which may be desirable in practice in the ratio of the length of entrance to that of run; although neither of

* Particulars will be found in Mr. Russell's work on "Naval Architecture"; also in vols. i. and ii. of the *Transactions* of the Institution of Naval Architects.

† See further on this subject the experiments of Mr. Froude mentioned at p. 462.

these can become very short in proportion to the speed without producing increased resistance. Suppose, for instance, that the common practice is adhered to, and the lengths of entrance and run made equal to one another: it may be desired to know what are the lengths appropriate to a speed of 16 knots. Here—

$$L_1 + L_2 = 0.937 \times (16)^2 = 240 \text{ feet (nearly).}$$

Professor Rankine, in 1868, suggested another mode of determining the limit of speed at which wave-making resistance begins to grow at a very disproportionate rate.* Taking the quotient of the volume of displacement divided by the area of the load-water section of a ship, he termed it the mean depth of immersion (k). The velocity of the waves which are formed by a ship he considered to be equal to that acquired by a heavy body in falling freely through a distance equal to half the mean depth of immersion; this velocity might therefore be expressed approximately by the formula—

$$\text{Velocity (feet per second)} = 4\sqrt{2k}.$$

If the actual speed of the ship exceeded this natural velocity of the waves formed by her advance, those waves would become divergent, and the wave-making factor of the resistance would increase. In other words, the limiting speed for economical propulsion was considered to be that expressed in the above formula. This theory was tested by observations made during the steam-trials of actual ships, and was fairly confirmed; but the observations were not sufficiently numerous to justify the general adoption of the method.

The experimental researches of the late Mr. Froude and of his son, Mr. R. E. Froude, have considerably advanced our knowledge of the general character of the waves which accompany ships. Those experiments have mostly been made on models; but the wave-phenomena thus observed have been repeatedly compared with similar observations made during the steam-trials of ships belonging to the Royal Navy. According to these observations, the waves produced by the motion of ships in deep water previously undisturbed may be classified as follows: (1) waves produced by the advance of the bow; (2) waves produced by the stream-line motions near the stern. Of these, the bow waves are more important. Each of these sets of waves may be divided into two distinct series: (1) *diverging waves*, the crest-lines of which trail aft; (2) *transverse waves*, of which the crest-lines are nearly perpendicular to the keel-

* See *Transactions of the Institution of Naval Architects for 1868*. The experiments made to test this theory were conducted by Mr. John Inglis.

line of the ship. Mr. Froude did not agree with Mr. Scott-Russell as regards the bow producing a solitary wave of translation; but considered that all the waves produced in deep water are gregarious (like deep-sea waves described in Chapter V.), successive crests following one another at regular intervals; those intervals, as well as the heights of the waves, varying with changes in the speed of the ship.

Taking the bow waves, for example, the highest crests appear near the bow of a ship, and against her sides. The lengths of the waves, measured outwards from the ship along the crest-lines, are only moderate, and they gradually die away to the level of still water towards the outer ends. The leading wave in each series is followed by a number of other waves, of which the heights gradually diminish as their distance from the bow increases, but the actual termination of the series of waves cannot be distinguished. Similar remarks apply to the two classes of stern waves. At low speeds neither the diverging nor the transverse waves attain such dimensions as to practically affect the resistance. At moderate speeds the diverging waves become apparent, and their crest-lines are commonly inclined aft at an angle of 40 to 50 degrees to the keel-line. It appears that only the leading wave in the diverging series at the bow touches the side of the ship in most cases, the highest points in the following waves in that series being at some distance from the ship. In other words, as the wedge-shaped entrance is driven forward it "throws off on each side a local oblique wave of greater or less size, according to the speed and the obtuseness of the wedge, and these waves form themselves into a series of diverging crests . . . which, after becoming fully formed at the bow, pass clear away into the distant water and produce no further effect on the "resistance." The "length," measured normally to the crest-lines of these diverging waves, appears to agree, or nearly so, with that of deep-water waves travelling at the speed which the ship's speed would give if resolved normally to the crest-lines. As the speed increases so do these diverging waves increase in magnitude, and represent a larger amount of resistance; and the wave phenomena are complicated still further by the appearance and rapid growth of the transverse series of waves as that limit of speed is approached where the wave-making resistance begins to grow rapidly in importance. When that limit is passed the transverse series of waves becomes even more important, affecting the total resistance very largely and sometimes very singularly.

In Fig. 149 is reproduced a drawing prepared by Mr. Froude to represent the result of careful observations of the wave phenomena attending the motion at a relatively high speed of a model having a

long middle-body. The drawing indicates the positions of the diverging waves, while the profile of the waves in the transverse series is defined against the side of the model. This profile was

FIG. 149.

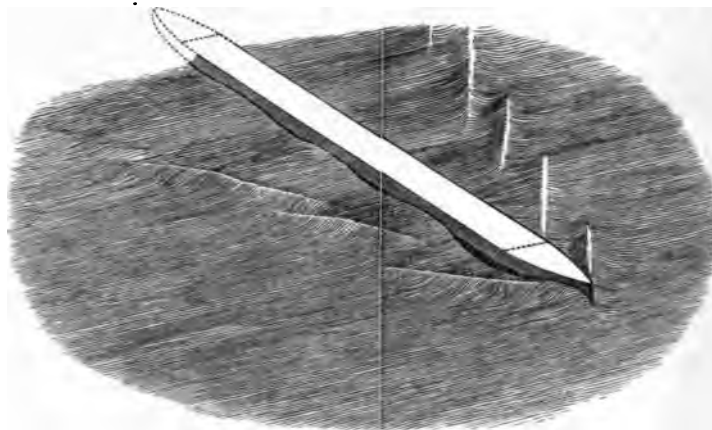

drawn from exact measurements, but the vertical scale is exaggerated for the sake of clearness, so that the waves appear about twice as high as they really were relatively to the model. Unlike the diverging waves, those in the transverse series appear directly behind one another, successive wave crests and hollows reaching the sides of the ship. In the diagram the distance from crest to crest is about 115 feet, the speed of the model corresponding to about $14\frac{1}{2}$ knots per hour for a full-sized ship. It will be observed that (in accordance with the formula on p. 204) an ocean wave having this speed would be about 120 feet in length, so that there is a very fair agreement between the observed waves and trochoidal waves of equal speed. Hence it appears that as the speed of a ship is increased, so the lengths from wave crest to wave crest will increase in the ratio of the squares of the speeds; and the positions of wave crests and hollows must vary, relatively to the ship, as her speed is varied. These variations in the relative positions of the waves and the after body of the ship were found, on analyzing the results of numerous experiments, to sensibly affect the resistance of models having identically the same entrance and run, with Fig. 149, but varying lengths of middle-body.

The earlier investigations of the late Mr. Froude on this important feature of wave-making resistance were made with a series of models having the same lengths and forms of entrance and run (160 feet), but varying lengths of middle-body—ranging from 340 feet down to nothing. The maximum speed appropriate to this length

of entrance and run, according to the formula on p. 459, would be rather less than thirteen knots; and so long as this speed was not exceeded, the wave-making resistance remained nearly of constant amount for all the models. At higher speeds considerable differences in the wave-making resistance were produced by variations in the total lengths of the models. When the length and speed of a model were such that a wave crest of the transverse series was placed at or near the middle of the length of the run, the wave-making resistance was decreased. On the contrary, if the length and speed were so related that a wave hollow of the transverse series occupied the position named, an increase in the wave-making resistance took place. Hence Mr. Froude argued that the absolute length of a ship as well as her length of entrance and run, must affect her resistance when moving at relatively high speeds; and that variations in speed must influence the resistance by altering the relative positions of the hollows and crests of the transverse series of waves situated near the stern of a ship.

These conclusions have been confirmed generally, and our knowledge of the subject much extended by the investigations of Mr. R. E. Froude.* It is impossible here even to summarize the valuable experimental results, and the provisional theory based upon the experimental investigations. By means of elaborate observations of the wave-phenomena accompanying the motion of models through water, the general characteristics of the bow and stern series of waves, classified above, have been determined. Moreover, it has been shown that the variations in wave-making resistance accompanying variations in speed, after a certain limit of speed has been passed in a given ship, may probably be explained by the "interference" of waves belonging to the transverse bow series, with the leading wave in the transverse series originated at the stern. That is to say, "the height of the waves made, and the amount of the resistance caused will be at the maximum or minimum according as the crests of the bow-wave series coincide with the crests or troughs of the natural stern-wave series. . . . In either of these two cases the crest of the resultant wave coincides with the crest of the larger of the two components, while, if the crests of one series fall on the slopes of the other, the resultant crest position will be a compromise between the crest position of the components, though nearer to the larger of the two."

The increase or diminution in resistance produced by variations in the relative positions of the wave crests or hollows near the stern of

* See the paper "On the Leading Resistance of Ships."—*Transactions* of the Institution of Naval Architects for 1881.

a ship is governed by various considerations. For example, the height of the leading transverse wave in the bow series is affected by the form of the entrance of a ship and the speed at which she is driven. Again, the height of the crest in that wave of the transverse bow series which lies on or near the stern, as compared with the height of the leading bow wave, will depend upon the number of intervening waves, which number will depend upon the length and speed of the ship. The form of the stern and speed of the ship also influence the magnitude of the waves originating there, and so of the waves composed of the bow and stern series. These general considerations do not, however, enable an exact estimate to be formed of the magnitude of wave-making resistance in a ship of given form moving at a given speed, and for this purpose model experiments are essential.

The following passage in the remarks of Mr. R. E. Froude deserves quotation, although it relates to a different aspect of wave-making resistance. He says, "It is a reasonable inference . . . "that the wave-making features of a ship will operate more effectively "to make short waves if their displacement is disposed broadwise "rather than deepwise; and more effectively to make long waves if "it be disposed deepwise rather than broadwise. Now, the diverging "waves being necessarily much shorter than the transverse waves, we "see that flaring-out the end sections of a ship, or increasing the ratio "of breadth to depth, will *cæteris paribus* tend to increase the resistance "due to diverging waves and diminish that due to transverse waves : "while giving U-sections or increasing ratio of depth to breadth will "have the opposite effects. These inferences are visibly corroborated "by the appearance of the wave systems caused in the cases referred "to. Again it is worth noticing that the experiments have shown "that, as a rule, moderately U-shaped sections are good for the fore-"body, and comparatively V-shaped sections for the after-body. "This would seem to show that in the wave-making tendency of "the after-body the diverging wave element is less formidable than "in that of the fore-body, and this inference corresponds with the "fact that the stern diverging-wave series is visibly less marked than "that of the bow."

Another important deduction from model experiments may be mentioned, before concluding these remarks on wave-making resistance. Supposing that the lengths of entrance and run provided in the design for a new ship to be ample in proportion to her intended full speed, a diminution in the total resistance may be usually secured by adopting still greater lengths of entrance and run, with finer lines at the extremities and a greater extreme breadth, the displacement remaining unchanged. This is contrary to the opinion formerly

entertained as to the influence on resistance of an increase in the area of the immersed midship section; but there is ample evidence of the truth of the principle. An excellent illustration is found in the experiments made with a model of the merchant steamer *Merkara*, and models of alternative forms but identical displacement.*

The dimensions of two of these vessels (in feet) were as under:—

Models.	Length.				Extreme breadth.	Mean draught.
	Entrance.	Middle-body.	Run.	Total.		
<i>Merkara</i> . . .	144·0	72	144·0	360	37·2	16·25
Model B . . .	179·5	Nil	179·5	359	45·88	18·0

The *Merkara* had an area of immersed surface of 18,660 square feet; model B an area of 19,130 square feet; the displacement in each case was 3980 tons. So far as surface friction went, therefore, the *Merkara* had a small advantage; as to eddy-making, the two ships must have been practically equal, and the difference in total resistance between the two would arise from differences in the wave-making resistance. On trial it was found that about 18 knots marked the limit of speed for the *Merkara*, where a slight increase in speed led to a disproportionately large increase in the wave-making resistance. At a speed of 19 knots the wave-making resistance of the model of the *Merkara* was found to be fully 60 per cent. of the whole resistance, whereas at the actual maximum speed of the ship—13 knots—wave-making resistance was only 17 per cent. of the whole. For model B up to speeds of 19 or 20 knots no disproportionate increase in the wave-making occurred; consequently the total resistance of B at a speed of 18 knots was only 75 per cent. that of the *Merkara*, whereas at 13 knots the difference in the resistances was very trifling.

Applying the formulæ of the wave-line theory to these two vessels, we have—

$$\text{For } \textit{Merkara} \sqrt{L_1 + L_2} = \sqrt{288} = 17 \text{ (nearly).}$$

$$\text{Limiting speed } V = 17 \times 1\cdot03 = 17\frac{1}{2} \text{ knots (nearly).}$$

$$\text{For model B } \sqrt{L_1 + L_2} = \sqrt{359} = 19 \text{ (nearly).}$$

$$\text{Limiting speed } V = 19 \times 1\cdot03 = 19\cdot57 \text{ knots (nearly).}$$

There is consequently a close agreement between theory and

* See the details given by Mr. Froude in vol. xvii. of the *Transactions* of the Institution of Naval Architects.

experiment as to the limit of speed beyond which the growth of resistance becomes disproportionately great.

Summing up the foregoing remarks, it appears—

(1) That *frictional resistance*, depending upon the area of the immersed surface of a ship, its degree of roughness, its length, and (about) the square of the speed, is not sensibly affected by the forms and proportions of ships; unless there be some unwonted singularity of form, or want of fairness. For *moderate* speeds, this element of resistance is by far the most important; for *high* speeds, it also occupies an important position—from 45 to 60 per cent. of the whole resistance in a very large number of classes when the bottoms are clean, and a larger percentage when the bottoms become foul.

(2) That *eddy-making resistance* is usually small, except in special cases, and amounts to some 8 or 10 per cent. of the frictional resistance. A defective form of stern may cause largely increased eddy-making.

(3) That *wave-making resistance* is the element of the total resistance which is most influenced by the forms and proportions of ships. Its ratio to the frictional resistance, as well as its absolute magnitude, depend upon many circumstances; the most important being the forms and lengths of the entrance and run, in relation to the intended full speed of the ship. For every ship there is a limit of speed beyond which each small increase in speed is attended by a disproportionate increase in resistance; and this limit is fixed by the lengths of the entrance and run—the “wave-making features” of a ship.

The sum of these three elements constitutes the total resistance offered by the water to the motion of a ship towed through it, or propelled by sails, when the depth of water is great in proportion to the speed. In a steamship there is also an “augment” of resistance due to the action of the propellers, as will be explained hereafter.

Effect upon Resistance of Shoal Water.—From the foregoing remarks on stream-lines surrounding a ship in motion, it will be obvious that when comparatively narrow limits are fixed by rigid boundaries to the vertical and horizontal extension of the water in which a ship moves, there must be great interference with the natural formation and gradation of the streams which would exist in an ocean limitless in extent and depth. It will be equally obvious that as high speeds are attained, and the wave-making part of the resistance becomes of great relative importance, limitations of depth and horizontal extension in the water around a ship must seriously hamper the formation and maintenance of the wave-series produced by her movement, as compared with the conditions holding good in a limitless ocean. Both these causes operate in the direction of

increasing the resistance of a ship moving at a given speed, as compared with the resistance experienced at the same speed in the open sea and in deep water.

Common experience confirms this statement. A ship moving through a shallow narrow channel, such as the Suez Canal, with her keel comparatively near the bottom, and her immersed bulk amidships occupying a considerable part of the cross-sectional area of the channel, is subjected to large additional resistance, the flow of water about her is altogether different from that in the open sea, and her steering often becomes uncertain. Under such circumstances of transit low speeds are practically necessary for other reasons, and consequently the undoubted increase in resistance has small practical importance.*

Experience equally proves that when ships or boats steaming at high speeds pass from deep to comparatively shallow water, they meet with increased resistance, and lose in speed if the same power continues to be developed by their engines. There has been a most notable increase in speed during recent years, and consequently the influence of shoalness of water upon the speed of steamships has become a matter of greater practical importance. When speeds of 20 knots and upwards are reached, depths of water which were ample for speeds of 12 to 14 knots become insufficient, in the sense that they are accompanied by a seriously increased resistance.† It is desirable, therefore, to explain briefly the principal causes of such increased resistance in shoal water.

Experiment and observation appear to show that so long as ships move at moderate speeds—within limits where the resistances vary as the squares of the speeds, and the wave-making has only a trifling effect—shoalness of water produces an increase in resistance which is a fairly constant percentage for a particular ship of the resistance in deep water for the same speed. In other words, if a curve of resistance in terms of the speed were obtained for deep water, then for

* In the *Annales des Ponts et Chaussée* (1889) M. Armand Saint-Yves has dealt with this matter in relation to ship-towage or propulsion in canals. He states that a large passenger-steamer, in passing through the Suez Canal, had an immersed midship sectional area equal to about 22 per cent. of the cross-sectional area of the channel, and for a given number of revolutions of the screw only obtained about 54 per cent. of the speed which the same number of revolutions

gave at sea. He further had recourse to model experiments in order to determine the loss of speed in canals. The results are very interesting. His conclusion was that for the Corinth Canal chain-towage was to be preferred, as requiring less power.

† Space is not available for the numerous examples on record. See on this subject a paper contributed by the author to the *Transactions* of the Institution of Naval Architects for 1892.

shoal water of a known depth, if the percentage of increase at any speed were ascertained, that percentage would apply to all other speeds within the moderate limits laid down. The percentage of increase would vary necessarily with the size of ship and her draught in relation to the depth of water. For water very shoal in relation to the draught the percentage may become a large one; and for depths of water from twice to thrice the draught it may be a very important factor in the total resistance, even at the moderate speeds specified.

At higher speeds, as explained above, wave-making assumes a very important position, and the total resistance varies at a higher power of the speed than the square. Under these conditions, relative shoalness of water may cause great increase in resistance, because there is serious interference with the formation and maintenance of the wave series appropriate to a given speed in deep water. In deep water that maintenance requires a considerable expenditure of power at high speeds. But when shoalness of water prevents the propagation of the wave series, or tends to degrade them and to alter their speeds, then clearly either greater power must be exerted by the propelling machinery to maintain a given speed, or the "drag" of the retarded waves upon the vessel will result in a lessened speed for a given development of power. From this point of view shoalness of water is a relative term, dependent to a great extent upon the speed of a ship, and of the waves around her.

The phenomena of deep-sea waves have been explained in Chapter V., and it now becomes necessary to sketch the corresponding phenomena for waves in shoal water. These latter were investigated by the late Professor Rankine, and the following remarks are chiefly based on his results.* Particles of water in waves moving in shallow water move in orbits which are approximately elliptical, instead of circular as in the deep sea. The minor axis of the elliptical orbit is vertical. For a given speed of advance in shoal water, the period and length of waves must be greater than those of deep sea waves of equal speed. Shoal-water waves having a certain period are less in length and speed than deep-water waves of the same period. The loss in speed in waves produced by shoalness depends largely upon the proportion of their lengths to the depths of water. This loss increases rapidly as that proportion increases—*i.e.* as the water becomes more shallow. Professor Rankine estimated that the loss would be sensible even when the depth of water was *five-twelfths* of the length of a wave, and at a depth equal to *one-third* the length

* For details, see the section on the motions of waves in "Shipbuilding Theoretical and Practical."

it would become marked, increasing rapidly with shoalness. An example or two will emphasize this. Suppose a ship to have a speed of 20 knots, and to be accompanied by waves of equal speed, which would be about 225 feet long from crest to crest. Then, by Rankine's rule water as much as 15 fathoms in depth would exercise a sensible check upon the wave motion, and consequently increase the resistance of the ship; while water 12 to 13 fathoms deep would cause a very serious "drag." If the speed were only 14 knots, the corresponding wave length would be about 110 feet, and by Rankine's rule (five-twelfths of length) the retarding effect of about 8 fathoms would correspond to that of 15 fathoms in the 20-knot ship. These examples emphasize what was said above respecting the growing importance of shoalness in view of the high speeds now attained. Increase in speed in a vessel of a given size being accompanied by this necessity for greater depth of water in order to prevent serious retardation, it will be obvious that when increase in size and draught accompany increase in speed that necessity becomes even greater. When a ship is driven at a speed where the resistance increases very rapidly with increase in speed, then the retarding effect of shoalness becomes most marked. Passage into shoal water then results in a serious check to the speed, and frequently there is a marked change and increase in height of the wave phenomena surrounding her.

The effect of relative shoalness of water has been very marked on the speed trials of some recent ships. A few examples out of many may be given. A torpedo-gunboat of the Royal Navy was run twice on the same measured mile on the same day. At high tide she attained a speed of 17.8 knots, whereas at low tide the speed for the same horse-power was fully half a knot less. The maximum depth of water was about 9 fathoms, and the minimum about 7 fathoms. On the measured mile in Stokes Bay, H.M. cruiser *Edgar* required 13,260 H.P. to attain $20\frac{1}{2}$ knots in 12 fathoms of water, and was accompanied in this shallow water by considerable wave phenomena. In water 30 fathoms deep, between Plymouth and Falmouth, the wave disturbance was much less, and the ship attained 21 knots with 12,550 H.P. On the trials of H.M. cruiser *Blenheim*, during the first hour, the depth of water was mostly about 9 fathoms, the engines made $92\frac{1}{2}$ revolutions, and developed 15,750 H.P., the speed of the ship being 20 knots. Under these adverse circumstances, the wave phenomena were most striking and unusual. Later on during the same trial the ship ran for two hours in water from 22 to 36 fathoms in depth, the same power was developed by the engines as in the first hour; but, in consequence of the greater depth of water, the engines made $96\frac{1}{2}$ revolutions, and the speed rose to $21\frac{1}{2}$ knots.

These examples illustrate the necessity for selecting measured distances having an appropriate depth of water, if the results of speed trials are to be trustworthy.

Recent Advances in Speeds of Ships.—In this connection it is natural that allusion should be made to the greatly increased speeds already realized by steamships, and to the probability of further increase. Atlantic passenger-steamers will serve to illustrate progress in the mercantile marine. In 1840 a mean speed of 8 knots on the voyage was considered satisfactory; in 1852 the mean speed on rapid passages had risen to 13 knots; in 1872 a mean speed of $14\frac{1}{2}$ knots was remarkable; and in 1882 equal distinction attached to a mean speed of 16 knots. Then began a period of unprecedented advance, passing rapidly from 18 to 19 knots, thence to 20·5 knots mean speed, and finally (1893) up to 21 or 22 knots on the swiftest passages. On voyages of much greater length, including that to Australia, a corresponding increase of speed has taken place, and is still in progress, mean speeds of 16 to 17 knots being realized already, and still higher speeds being contemplated.

In war-ships equally notable progress has been made. Taking performances on the measured mile as fair means of comparison between war-ships of different classes, it appears that up to 1860 a measured mile speed of $12\frac{1}{2}$ knots had been considered the maximum for battle-ships. When armour was introduced the maximum speed was raised to 14 or $14\frac{1}{2}$ knots, and this standard practically remained unchanged until 1880. Since that time the corresponding speeds for battle-ships have reached 17 to $18\frac{1}{2}$ knots. For cruisers a greater increase in speed has been realized. Starting from the finest unarmoured frigates of 1860 with measured mile-speeds of 13 knots, speeds of 15 to $16\frac{1}{2}$ knots were realized in the swift unprotected cruisers built from 1866 to 1870. The despatch ships *Iris* and *Mercury* realized speeds of 18 to $18\frac{1}{2}$ knots in 1878. At the present time protected cruisers attain measured-mile speeds of 20 to 23 knots.

Torpedo-boats of comparatively small size have surpassed in speed, on their smooth-water trials, all other classes of vessels. Vessels of 50 to 100 feet in length have been driven at speeds of 16 to 22 knots an hour; vessels of 130 to 150 feet in length have attained 23 to 26 knots; and vessels of 180 to 200 feet have been driven at 27 knots. These results would have been regarded as impossible twenty years ago. They are interesting not merely as notable illustrations of progress achieved, but as indications of still further progress that may be made. It is desirable, therefore, to look more closely into the conditions which hold good at speeds which are so very high in relation to the dimensions of the vessels. Informa-

tion has been obtained by elaborate and carefully conducted steam trials, and also by model experiments.*

The first deduction from these experimental results is that the expenditure of power in relation to the weights driven is abnormally great, when compared with the expenditure at equal speeds in larger vessels. This will be dealt with hereafter on the theoretical side. The following figures will illustrate the point. The *Iris* despatch vessel of the Royal Navy is 300 feet long, and of 3300 tons displacement on trial. At the speed of 18 knots the resistance is less than the *one-hundredth* part of her weight. At the same speed in a torpedo-boat about 80 feet long and 35 tons displacement, the corresponding resistance would be *one-sixteenth* of her weight. The *Shah* unprotected cruiser, 335 feet long and 6250 tons displacement, could be towed at 16 to 17 knots, with a tension on the tow-rope less than *one two-hundredth* part of her weight; for the torpedo-boat the corresponding tension would be *one-twentieth* of her weight. At 12 knots the merchant steamer *Merkara* (whose dimensions appear on p. 465) can be towed by a tension less than *one four-hundredth* part of her weight; for the torpedo-boat the corresponding tension would be about *one-fortieth* of her weight. A first-class cruiser, such as the *Blake*, of 375 feet in length and 9000 tons, can be towed at 22 knots by a tension of about the *one hundred and twentieth* part of her weight; whereas for a torpedo-boat destroyer of about 200 feet in length and 220 tons, the tension at the same speed would be the *twenty-seventh* part of her weight.

It will be obvious that torpedo-boats do not conform to the rules above laid down for lengths of entrance and run appropriate to the high speeds attained. Their total lengths are, in fact, often as little as *one-fourth* or *one-fifth* the combined lengths of entrance and run according to the rules. At the higher speeds there is a wide departure from the laws which usually hold good for the relation between the resistance and the speeds of ships when moving at speeds for which the lengths of entrance and run are fairly approximate to those which the rules would indicate. Within such limits of speed the resistance first varies nearly as the square of the speed, and as the speed increases the resistance varies at a gradually increasing power of the speed. Taking the *Iris* as an example, the following figures are interesting. Up to 13 knots per hour the resistance varied nearly as the square of the speed. The power of

* See papers by the leading English torpedo-boat builders, Messrs. Thornycroft and Messrs. Yarrow, in the *Transactions* of the Institution of Naval Archi-

tects from 1883 onwards, as to steam trials. As to model experiments, see a paper by Mr. R. E. Froude, in the same *Transactions* for 1881.

the speed gradually increased beyond the square, and at 18 knots approached the cube. For higher speeds a still higher power of the speed would represent the law of increase in the resistance. Contrast with these results the performances of a torpedo-boat 80 feet long. Up to 10 knots per hour the resistance varied nearly as the square of the speed. The law of increase gradually altered, until at 13 knots the resistance varied at a rate exceeding the *cube* of the speed. With further increase in speed the law of the resistance changed, and the power of the speed expressing it, after passing through a maximum, began to diminish, until at 18 knots it was *less* than the *square*. In other words, when these small craft are driven at abnormal speeds, the resistance varies at a less power of the speed than it does at 6 to 8 knots, when frictional resistance is almost the sole obstacle to progress. This remarkable departure from ordinary rules was first remarked in the steam trials of some of the earlier boats, and was considered to be open to doubt. It has since been confirmed by numerous steam trials of similar vessels and by model experiments. Similar phenomena would occur in vessels of larger size if they were pressed to very high speeds. In the *Iris*, for example, at 30 to 40 knots per hour, the law of variation of the resistance would be about the same as the 80-foot torpedo-boat at 18 knots. In a ship 600 feet long and of similar form to the torpedo-boat, the speed corresponding to 18 knots in the boat would be about 48 to 50 knots. Torpedo-boats, therefore, are excellent models from which the resistances of larger vessels at extraordinarily high speeds may be approximately estimated.

The wave-making phenomena attending the motion at very high speeds of torpedo-boats have been very carefully observed both in model experiments and on the steam trials of boats. Hence it has been ascertained that these phenomena accord with the general laws sketched above, and that the transverse series of waves, having lengths and speeds appropriate to the speed at which a boat is driven, are well developed. At the maximum speeds the boats are carried on the back slope of one of these waves, and there are great alterations of trim from the still-water condition. Mr. Yarrow has made a series of experiments on the changes of trim accompanying changes in the speed of some of the torpedo-boats built by him, noting at the same time the profile of the wave water along the sides of the boat. From the results which he has communicated to the author one example has been taken, and illustrated by Fig. 150. It is the case of a boat about 80 feet long, steaming at a speed of $18\frac{1}{2}$ knots an hour. She was found to alter trim about $\frac{1}{2}$ inch to the foot when under way, which on her length would make a rise of 40 inches of the bow relatively to the stern. On the other hand,

the bow rose relatively to the water surface rather more than a foot, while the stern sank less than six inches. In short, as was above remarked, the boat at this high speed was carried on the

FIG. 150.

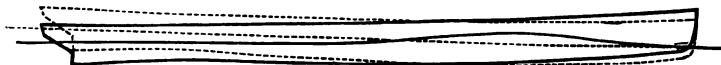

Fig. 150.—*Note.* The *dotted lines* show the outline of boat and water surface when she is at rest in still water. The *drawn lines* show the corresponding particulars for full speed.

back slope of a wave which she had created, and which was travelling at about the same speed as herself.

Experience shows that the sinkage at the stern may be considerably lessened by the adoption of suitable forms, in which the horizontal sections are kept full, and the fineness obtained by “cutting up” the stern, and practically abolishing any “dead-wood.”

Model experiments have been carried to much higher speeds in relation to dimensions than have been attained in the swiftest torpedo-boats. Mr. Froude has determined, for example, the resistances of models moving at speeds corresponding to 130 knots per hour, for ships of certain dimensions. With suitable precautions as to the scale of the models and the arrangements of the experimental apparatus, the method of experiment devised by Mr. Froude will suffice to deal with any problem that can arise, so far as the determination of resistance is concerned. The principal difficulties to be overcome in still further increasing speed are connected with the development and utilization of the engine-power necessary to overcome that resistance, with the additional risks inevitable to navigation at these higher speeds, and with the human element in management. There have been many proposals for modifying the forms of ships in such a manner as should enable them to attain extraordinarily high speeds on moderate dimensions. None of these plans has stood the test of experiment, or found acceptance with naval architects. It is certain that no modification of form can enable a vessel moving at high velocity through water to escape from a great resistance, involving a large proportionate power. Improvements may, of course, be anticipated in the materials available for ship and engine construction, in types of propelling machinery, and in sources of power. These changes may result in the production of ships of more moderate dimensions than can now be produced capable of attaining a certain speed, and they may render possible the attainment of much higher speeds. Even with existing materials and types of machinery higher speeds are not difficult to attain,

although they are costly. In the mercantile marine, limits of speed are necessarily governed or largely influenced by commercial considerations. The increase in speed to which allusion has been made above, has been associated with great increase in the size and costs of individual ships, notwithstanding improvements in structural materials and arrangements, and remarkable advances in marine engineering. In war fleets the sizes and costs of ships have also been increased, because of the increase in speed, although other features of the designs have exercised great influence in the actual dimensions and outlay. Reviewing the past history of steam navigation, no one can imagine that the upper limit of speed has yet been attained, or fix that limit on any certain basis.

Problems of Ship Design as affecting Forms and Resistances.—The problem to be solved by the naval architect is not to determine any exact geometrical form of least resistance of which he can make use in all cases, but in each of his designs to select those forms and proportions which are compatible with the special conditions to be fulfilled, and which will make the resistance as small as possible. Even when thus narrowed the problem is one of considerable difficulty, as the selection of forms involves also the questions of first cost, and working expenses in all ships, together with possible earnings in merchant ships. Very often the forms which would minimize resistance have to be set aside in favour of those essential to stability, handiness, or economy of construction and maintenance. This is especially true in war-ships, and it is desirable to emphasize and illustrate the limitations under which a designer has to work.

Handiness is an important quality in war-ships. In order that ships may be turned rapidly and in a small space moderate lengths have been adopted in war-ships; although it is thoroughly understood that great length is favourable both to the economical propulsion of ships and to the maintenance of speed in rough water. Before locomotive torpedoes were introduced, ram-attacks were even more important than at present, and more moderate speeds were customary. For the largest battle-ships, lengths of 300 to 330 feet were seldom exceeded; and for cruisers, 300 to 350 feet. Now lengths of 380 to 400 feet are adopted in the largest and swiftest ships of war afloat. The tendency is to greater lengths as speeds are increased, and the new cruisers of the *Powerful* class designed (in 1893) for a sea-speed of 20 knots are 500 feet in length. In merchant ships, of course, the power of turning rapidly in a small space has not equal importance, and practically puts no limit on length.

The provision of the necessary *stability* in war-ships also largely influences the ratios of beam to length and beam to draught. This

has been explained in detail in Chapter III. Here it is sufficient to state that the vertical distribution of the weights in war-ships is fixed to a great extent by the disposition of armour, armament, and coal. Heavy weights have to be carried high up, whereas in merchant ships the heavy weights of cargo are carried low down. Consequently ratios of length and draught to beam can be adopted in the latter which are not possible in the war-ships, as they would not give the necessary stability. Much confusion arises in criticisms of war-ship designs, particularly as regards the ratio of beam to length, and this will be further discussed. The ratio of beam to draught has, of course, the greatest influence on stability.

The disposition and thickness of the armour and protective decks in war-ships exercise much influence on the dimensions and proportions. It may, and does, happen that first cost is much reduced by accepting greater resistance and larger engine-power, because limitation of length carries with it a greater reduction in the weight and cost of the armour. Or it may be that the forms and proportions are governed by consideration of the probable damage and loss of stability which may occur in action. The central-citadel ships mentioned on p. 96 are examples of this. Similar considerations do not arise in merchant-ship design.

Many classes of war-ships have good sail-power as well as steam-power. Hence they are of moderate length and considerable beam to secure stiffness and handiness under sail, and economical propulsion under steam has to be sacrificed to some extent. The difficulty is increased, of course, by the vertical distribution of weights in the war-ship; and merchant ships dependent entirely on sails can and have given to them greater ratios of length and draught to beam, while retaining ample stability. In merchant steamers the sails carried are too small in area to have any practical influence on the selection of form.

Her Majesty's ship *Greyhound*, of which the name has become well-known in connection with Mr. Froude's experiments, is in all respects a contrast to the merchant steamer *Merkara*, and a comparison of the resistances experienced by the two vessels when moving at the same speeds will serve to point the preceding general statement. The dimensions of the *Merkara* have been given on p. 465. The following are the particulars of the *Greyhound*: Length (from stem to body-post), 160 feet; breadth extreme, $33\frac{1}{8}$ feet; mean draught, $13\frac{1}{4}$ feet; displacement, 1160 tons; area of immersed surface, 7540 square feet. In order to ascertain the resistance, the *Greyhound* was towed by the *Active* at varying speeds, the maximum being about 13 knots. When she moved through the water, the vessel necessarily communicated motions to the water in her neighbourhood, the

general character of these motions having been indicated in the preceding sketch of the stream-line theory. Changes in her own speed must have been accompanied by corresponding changes in these motions; and thus, in addition to the ship herself, a certain weight of water, which may be regarded as associated with her, must have undergone changes of speed corresponding to those impressed on the ship. Mr. Froude obtained data from which to estimate this weight of water, making special experiments for the purpose, and found it to be about one-fifth or one-sixth the weight of the ship. The *virtual* weight of the *Greyhound*, when towed, was, therefore, about 1400 tons. The tow-rope strain, or resistance, corresponding to various speeds was found to be as under. For purposes of comparison, the corresponding approximate results for the *Merkara* are also given; her actual weight being 3980 tons, and her virtual weight perhaps 4600 or 4700 tons.

Speed of ships.	Resistance (in tons).	
	<i>Greyhound.</i>	<i>Merkara.</i>
4 knots	0·6	1
6 "	1·4	2·3
8 "	2·5	3·9
10 "	4·7	6
12 "	9	9

The full speed of the *Greyhound* when driven by her own steam power was 10 knots; at that speed the resistance was only $\frac{1}{3\frac{1}{2}}$ part of her actual weight: 13 knots is the full speed of the *Merkara*; the corresponding resistance (11·5 tons) is only $\frac{1}{3\frac{1}{2}}$ part of the actual weight. It will be remarked that for speeds, below 8 knots, where frictional resistance constitutes almost the whole resistance, the greater surface of the bottom of the *Merkara* makes her resistance greater than that of the *Greyhound*; but at the higher speeds the greater wave-making resistance of the shorter and smaller ship makes her total resistance gradually approximate to that of the *Merkara*.

So long as frictional resistance forms the larger part of the total resistance, the law which was formerly received as general holds fairly well, the resistance varying nearly as the square of the speed. In the *Merkara*, for example, the law holds very closely up to the speed of 13 knots, at which the frictional resistance formed about 80 per cent. of the total. In the *Greyhound*, the same law holds very fairly up to about 8 knots only, the frictional resistance at that speed being about 70 per cent. of the total; but beyond that speed the gradual

growth in importance of the wave-making factor makes the total resistance vary with a higher power than the square of the speed. At 10 knots it varies nearly as the cube of the speed; and at 12 knots, nearly as the fourth power, the frictional resistance then being only 35 per cent. of the total. This contrast illustrates the principle previously laid down, that considerable lengths of entrance and run and fine forms are advantageous, not merely in adapting vessels for high speeds, but in keeping down the law of increase in terms of the velocity for more moderate speeds. If economical performance under steam had been the sole or principal condition to be fulfilled in the *Greyhound*, it would undoubtedly have been preferable to adopt greater proportions of length to breadth, and finer forms at the extremities; then, with the same lengths of entrance and run, associated perhaps with a certain length of middle body, there would probably be somewhat greater frictional resistance than in the actual ship, but a very considerable decrease in the wave-making resistance, and on the whole a less resistance would have to be overcome in obtaining the designed speed. Such latitude of choice in forms and proportions was not, however, possible in the design of the *Greyhound*. She was intended to be efficient under sail, as well as to have moderate speed under steam; hence, moderate proportions of length to breadth became necessary, in order to secure sufficient "stiffness" and handiness. The lengths of entrance and run in the *Greyhound* were each 75 feet; so that, according to the formulæ on p. 459, no abrupt and inordinate growth of wave-making should have occurred during the experiments. Nor did any such sudden change take place, although the bluff form of the ship made the wave-making factor in the resistance of such considerable amount.

It has been remarked above that confusion sometimes arises between the influence upon resistance of *absolute length* and that of the *ratio of length to beam*. Repeated illustrations have been given of the advantages resulting from additional length so far as diminution of resistance is concerned, especially at high speeds. Experiment and experience demonstrate, however, that the popular conception that increase in the ratio of length to beam must be accompanied by more economical propulsion is an error. Probably it arose in great part from the excellent results obtained in the mercantile service from successive additions to the lengths of ships, with little if any increase in beam. In some instances, keeping the same ~~lengths~~ forms of entrances and runs, which were ample for the ~~maximum~~ working speeds, the length of middle body has been ~~increased~~ by step in successive ships, and large additions made to ~~the~~ power, while the speed has been maintained with ~~an~~ engine-power. From the commercial point of view, a ~~large~~

speeds at which cargo-steamers work, this policy has no doubt been advantageous. On the other hand, the experiments of Mr. Froude, mentioned on p. 462, have shown that such forms, with considerable lengths of uniform cross-section, are not so well adapted for high speeds as are forms in which, with the same total length, the extreme breadth has been increased and the lengths of entrance and run made greater, while the extremities were given finer forms. These investigations have done much to dispel the prejudice against increased beam which formerly prevailed, because it was thought that increase in the area of the immersed midship section involved increased resistance. This erroneous opinion has in many cases led to the adoption of such narrow beam that the conditions of stability have been unsatisfactory. Since Mr. Froude published the results of his experiments the matter has been better understood, and in many cases greater ratios of beam to length have been adopted both in cargo-steamers and in passenger-steamers of high speed, with results fully confirming his conclusions. These he summed up in the following passage:—*

“In view of the importance of large carrying power combined with limited draught—a limitation which the Suez Canal has done much to emphasize—and I may add, in view of the practical sufficiency of what may be called moderate speed, the prevailing tendency to great length, including a long parallel middle body, is a fair result of ‘natural selection.’ This form, if rationally treated, is perhaps, under the conditions indicated, the best adapted for commercial success; though where deep draught is unobjectionable, a shortened form with no parallel middle would be unquestionably superior; or were it an object to obtain very high speed, without notable increase of resistance, parallelism of middle body would even with the longer form be inadmissible. The logic of the circumstances shapes itself thus: Large displacement means large dimensions, somehow or somewhere; but the limitation of draught forbids enlargement of dimension except in the direction of length, since increased ratio of breadth to depth would involve an objectionably raised metacentre, and objectionable increase of skin; greatly extended length has, therefore, for mercantile purposes become essential to large carrying power. Now, with a very long ship, if the ends are so far fined as in effect to limit the resistance to surface friction, the parallelism of the remainder clearly assigns a valuably increased carrying power to the ship as

* See p. 184 of the *Transactions* of the Institution of Naval Architects for 1876. An interesting paper by Mr. Biles, and a valuable discussion thereon, appear in the *Transactions* for 1883.

“a whole; or, what comes to the same thing, secures a given carrying power with less total skin and therefore less resistance at moderate speed.”

Model Experiments on Resistance.—In the present state of knowledge, the determination of the resistances of ships is necessarily a matter for experiment rather than of direct estimate from established principles. Apart from experiments, great uncertainty must attend any estimates for resistances and engine-powers required for the attainments of specified speeds in new types of steamships, or when departures have to be made from precedents. Vessels similar in form and not very different in speed from ships that have been completed and tried can be dealt with in a fairly accurate manner, as described in Chapter XVII. Radical changes in forms or proportions, and wide departures in speed, must be attended with uncertainty unless the designs are based on experiments. Such experiments on full-sized ships are difficult and costly; and until Mr. Froude took the matter up experiments with models were regarded as untrustworthy. Twenty years' experience with the experimental establishment which he founded with assistance from the Admiralty, and which in later years has been taken over entirely by the Admiralty, has established beyond question the utility and value of this method of inquiry into the resistances of ships. At a moderate expense of time and money, it is now possible to predict from model experiments the resistances of vessels of the most novel form and of unprecedented speeds. In connection with the design of her Majesty's ships, great economies have been effected by the selection of the best forms available under the specified conditions, and problems of great difficulty have been solved.

A committee was appointed by the British Association in 1868, to report “on the state of existing knowledge on the stability, propulsion, and seagoing qualities of ships.” The members were men of high standing and professional reputation. They recommended in their report a series of experiments to be made in order to determine the resistances of full-sized ships, and regarded model experiments as of doubtful value. Mr. Froude dissented from this report, contending that “experiments on the resistances of models of rational size, when rationally dealt with, by no means deserve the mistrust which they are usually dealt with; but, on the contrary, can be relied on as truly representing the resistances of the ships of which they are the models.” He supported his views by numerous experiments, and, the value of his method being recognized by the professional officers of the Admiralty, steps were taken to give it practical effect. On the theoretical side, it is true, M. Reech

had anticipated Mr. Froude in laying down mathematical conditions for the "scale of comparison" between ships and models. Mr. Froude, however, was unaware of M. Reech's work, and independently investigated the matter. He also devised the delicate mechanical apparatus necessary for making and recording the results of the experiments; and to him belongs the honour of introducing a system of inquiry which has already been of great benefit to naval construction, and must become increasingly valuable. As stated above, the system has been adopted in Holland, Russia, and Italy. Messrs. Denny of Dumbarton have an establishment of their own. It has been desired to create similar establishments at Glasgow University and at the Newcastle College of Science. Steps in the same direction have been taken by the United States naval authorities; and in France work of the same kind has been done.

In addition to the accumulated experience of twenty years, during which the system of model experiments has been successfully applied to the designs of ships for the Royal Navy, there have been a few direct comparisons made between the tow-rope resistances of actual ships and their models. The first of these, mentioned in the preceding pages, was made on H.M.S. *Greyhound*, the experiments being conducted by Mr. Froude. Practical agreement was established at all speeds between the results of the towing-trials made on the ship and the estimated resistances based on the model experiments. A second comparison was made in 1883 between the results of towing-trials made on a first-class torpedo-boat by Mr. Yarrow, and those of model experiments conducted by Mr. R. E. Froude in the Admiralty establishment.* Here there was also virtual agreement between boat and model, the latter giving results about three per cent. less than the full-scale towing-trials. Having regard to the high speeds in relation to dimensions reached in these later trials, they are in some respects a more severe test than the *Greyhound* experiments made ten years earlier.

As such importance attaches to these experiments, a brief account will be given of the process by which the resistance of a full-sized ship is obtained from the resistance of a model. For this purpose, Mr. Froude made use of a "scale of comparison," based upon the stream-line theory, and stated it as follows: "If the ship be D "times the dimension of the model, and if at the speeds V_1, V_2, V_3 ". . . the measured resistances of the model are R_1, R_2, R_3 "then for speeds $V_1\sqrt{D}, V_2\sqrt{D}, V_3\sqrt{D}$. . . of the ship, the "resistances will be D^3R_1, D^3R_2, D^3R_3 . . . To the speeds of the

* See the *Transactions* of the Institution of Naval Architects for 1883.

“model and ship thus related it is convenient to apply the term “*corresponding speeds.*” This general statement will, perhaps, be better understood by an example; and we will take that published by Mr. Froude for the *Greyhound*, and illustrated by Fig. 151.*

The curve AA in the diagram is termed a “curve of resistance”; measurements along the base-line XY representing speeds (in feet

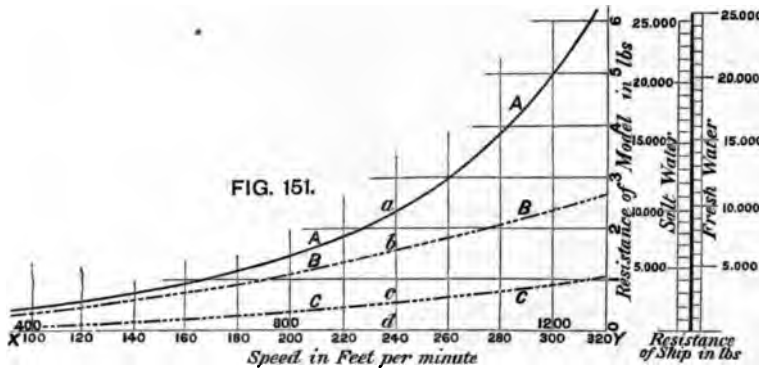

per minute), and the length of the ordinates drawn perpendicular to XY representing the resistances of a ship or model (in pounds) at the various speeds. To construct the curve, the model is towed at a certain speed—say, 240 feet per minute—and its resistance recorded by means of suitable dynamometrical apparatus; a length (*ad*, in Fig. 151) representing this resistance is then set off along the ordinate drawn perpendicularly to XY at the point (*d*) corresponding to the speed. This process having been repeated for a considerable number of speeds, a series of points (such as *a*) is determined, and through these the curve AA is drawn. By simple measurement of an ordinate of this curve the resistance can be ascertained at any speed within the limits over which the experiments extend. Having measured the immersed surface of the model, and ascertained by experiment its proper coefficient of friction, the frictional resistance can be easily calculated for each of the experimental speeds. The value of the frictional resistance at each speed is then set off from the base-line XY, on the same scale as was chosen for the total resistance curve AA, the length *db* representing the frictional resistance at the speed of 240 feet. A curve of frictional resistance (BB) is thus obtained for the model; and this operation completes all that need be done for the model, furnishing

* See full particulars published in vol. 15 of the *Transactions* of the Institution of Naval Architects, which also

contains descriptions of the apparatus used.

the data from which the resistance of the full-sized ship can be estimated.

In the case of the *Greyhound* the scale of the model was *one-sixteenth* that of the ship: hence for the scale of comparison mentioned above, $D=16$; $\sqrt{D}=4$; and the "corresponding speeds" of the ship will be *four times* those of the model. In Fig. 151 the speeds in feet per minute marked *below* the line XY are speeds for the model; those marked *above* the line are speeds for the ship. For resistances at the corresponding speeds, the law stated above becomes—

$$\begin{aligned}\text{Resistance of ship} &= (16)^3 \times \text{resistance of model} \\ &= 4096 \times \text{resistance of model.}\end{aligned}$$

This change, therefore, simply amounts to an alteration in the scale of measurement of the ordinates of the curve AA; whatever length represents 1 lb. for the model must represent 4096 lbs. for the ship. The appropriate correction is made in Fig. 151 by the scale of "resistance of ship" drawn at the right-hand side of the diagram. It will be remarked that this scale provides for resistance in fresh water as well as in sea-water, the salt-water resistance exceeding that for fresh water in the ratio in which the density is greater than that of fresh water; but this is not an important feature of the experiments, having been introduced only because fresh water is used in the experimental tank. Having corrected the vertical scale of resistance in the manner described, it would be possible to measure the resistance of the ship for any speed from the ordinates of the curve AA, were not a correction needed in the frictional resistance (as explained on p. 443) on account of the length of the ship exceeding that of a model so greatly. This difficulty Mr. Froude met by a simple device. The frictional resistance of the ship is calculated for the various speeds, making use of her actual coefficient of friction (allowing for her greater length), and these values are set off (on the proper scale, and on ordinates representing the corresponding speeds) downwards from the curve BB, which represents the frictional resistance of the model; through the points thus determined the curve CCC is drawn. Then, to determine the resistance of the ship at any speed, instead of measuring from the base-line XY, it is necessary to measure from the line CC.

Take, once more, the speed of 240 feet per minute for the model; this represents a speed of 960 feet for the ship (or about $9\frac{1}{2}$ knots per hour). The length *ac* on the ordinate, corresponding to this speed, represents the total resistance of the ship, on the proper scale; and the length *bc* represents on the same scale the frictional resistance of the ship, while *cd* represents the diminution of the

frictional resistance of the ship as compared with the model, and will be seen to be of considerable amount.

In the conduct of these experiments the greatest care is needed to secure uniform motion of the models at any assigned speed, as well as the correct measurement of the strain on the towing apparatus, and the avoidance of any conditions which would render the behaviour of the model dissimilar from that of the ship represented when she is moving at uniform speed in smooth water of great depth and extent. It will be obvious that any errors made in the model experiments will be greatly magnified in passing from the model to the ship; but the possibility of such errors occurring has been minimized by the beautiful apparatus contrived by Mr. Froude, this apparatus being to a large extent automatic in its action and giving a continuous record of the results for each run of a model at a certain speed.

Supposing the resistance of a model to have been accurately determined by experiment, its practical usefulness depends upon two conditions: (1) the accuracy of the law of "corresponding speeds"; (2) upon the possibility of making an approximation to the correction in frictional resistance required in passing from the model to the ship. The latter condition was dealt with by Mr. Froude on a principle which was, we believe, entirely novel—in that he not merely obtained by experiment the corrected coefficients of friction for the excess in length of the ship as compared with the model, but also saw that, because the frictional resistance varied at all speeds as some constant power of the speed, it must be treated separately from the other factors in the total resistance. Froude's generalization embodied in his scale of comparison for ships and models was not applied to the total resistances, but to those resistances less the frictional resistances.

M. Reech, in his *Cours de Mécanique*, published in 1852 for the use of the students of *L'Ecole d'Application du Génie Maritime*, had established, on the basis of a theorem of Newton's on "Similarity of Motions," a law of comparison for the resistances of floating bodies, of similar forms but different sizes, which is practically identical with Mr. Froude's law.* M. Reech clearly indicated also that this

* Readers interested in the matter will find Reech's investigation reproduced as an Appendix to a valuable paper by the late Mr. W. Denny, published in the *Transactions* of the Institution of Shipbuilders and Engineers in Scotland for 1885. It is but right to state that,

owing to the author's acceptance of the British Association Report without verification by reference to M. Reech's work, in earlier editions of this book sufficient justice has not been done to that eminent French investigator.

law of comparison might be applied to the comparison of resistances of ships and models, but strictly held good only when frictional resistance followed the same general law as the other forces. He remarked, further, that frictional resistances probably varied about as the square of the speed. In fact, he completely stated the law of comparison in a mathematical form, but made no experimental application thereof, nor, so far as can be ascertained, did any of his pupils until after the date when Mr. Froude took this matter in hand. A reference is made to M. Reech's investigations in the Report of the Committee of the British Association (1868) above mentioned, but it is of a misleading character, and gives only an imperfect idea of the generalization made. Mr. Froude, it is known, worked out his law quite independently on the basis of the stream-line theory of resistance, without any knowledge of what M. Reech had done previously.

Mr. Froude reasoned on the following lines. According to the stream-line theory, the "displacements" which the motion of a wholly submerged body imposes upon the surrounding fluid are for a given body identical in configuration at all velocities, and this configuration is similar for all similar bodies. This law of similarity would also hold good for a partially submerged body if the surface of the fluid were supposed to be uninfluenced by gravity, and consequently the wave phenomena—the "upward disturbances of the surface"—would be identical for the same body at all speeds, and be similar for similar bodies. As a matter of fact, the elevations and depressions of the surface are the results of the joint action of gravity and the stream-line accelerations; and hence it follows that the surface disturbances in two similar bodies "will retain their similarity wherever, and in the manner which, the operation of gravity permits; and this will be when the similar bodies are moved with velocities proportioned to the square roots of their respective dimensions." When the two similar bodies move at those "corresponding speeds," the configurations of the waves are similar, and the energy expended on wave-making will vary with the cube of the dimensions; because the mass elevated is as the square of the dimension, and the elevation is as the square of the speed—that is to say, as the dimension.

The correctness of this reasoning has been verified by very many observations made on models of similar forms but different sizes, and by a comparison of the wave-phenomena of models with those of ships. Careful observations of the waves accompanying models are usually made in association with the resistance experiments; and in very many cases the waves raised by ships themselves have been carefully noted and found to be similar to those raised by the

respective models. Having thus established the similarity for ships and models, it is a great practical advantage to be able to study the wave-phenomena on the moderate scale in which they occur in model experiments, instead of having to deal with the large dimensions incidental to the motion of full-sized ships; Mr. Froude fully realized the possibilities thus opened to him, and one of the principal aims of his experiments was "to deduce general laws by which the influence of variation of form upon wave-making resistance might be predicted." Unfortunately, the task so ably undertaken was left incomplete; but, from the investigations already made by Mr. R. E. Froude, and the work now in progress at other experimental establishments, it may be hoped that his intentions will yet be realized.

In the special case where the resistance varies as the square of the speed, it is easy to show that the law of comparison above stated holds good, apart from the correction for surface friction in the ship as compared with the model. Suppose a wholly submerged body to have S_1 square feet of wetted surface, then, for a speed of V_1 feet per second, we should have—

$$\text{Resistance} = R_1 = K \cdot S_1 V_1^2 \dots \dots \dots (1)$$

where K is a coefficient determined by experiment. For another body of similar form, having the wetted surface S_2 and moving at the speed V_2 —

$$\text{Resistance} = R_2 = K \cdot S_2 V_2^2 \dots \dots \dots (2)$$

whence it follows that—

$$\frac{R_1}{R_2} = \left(\frac{V_1}{V_2}\right)^2 \cdot \frac{S_1}{S_2} \dots \dots \dots (3)$$

If the first body have lineal dimensions D times those of the second, then—

$$\frac{S_1}{S_2} = D^2 \dots \dots \dots (4)$$

and further, if the velocities V_1 and V_2 are related to one another as the square roots of the lineal dimensions—

$$\frac{V_1}{V_2} = \sqrt{D}; \text{ and } \left(\frac{V_1}{V_2}\right)^2 = D \dots \dots \dots (5)$$

Substituting from (4) and (5) in (3), we have at these "corresponding speeds"—

$$\frac{R_1}{R_2} = D \times D^2 = D^3 \dots \dots \dots (6)$$

Under this limited assumption, therefore, the law of comparison holds good.

If in equation (3) V_1 equal V_2 , that is, the speeds are equal in both bodies—

$$\frac{R_1}{R_2} = \frac{S_1}{S_2} = D^2 \dots \dots \dots (7)$$

The wetted surfaces in each case are proportional to the *two-thirds* power of the displacements; say W_1 and W_2 . Hence—

$$\frac{R_1}{R_2} = \left(\frac{W_1}{W_2}\right)^{\frac{2}{3}} \dots \dots \dots (8)$$

This is an expression to which reference will again be made in Chapter XVII.

In addition to their primary and most important purpose—the determination of the resistances of ships—model experiments have yielded much valuable information respecting the behaviour of ships when moving through still water. A few examples may be given.

The recording apparatus enables a record to be kept of the vertical motions which the centre of gravity of a model performs as the speed is varied, and the changes of trim which take place. It has thus been ascertained that ships moving at ordinary speeds usually sink bodily below their still-water draught, and that at such speeds the bow usually sinks more than the stern. There will be no difficulty in accounting for these changes of level when the character of the stream-line motions, and the variations in the resultant pressures of the water upon the different parts of the length of a ship, are considered; nor will it be a matter for surprise that when the cross-sections of the bow of a ship are **V**-shaped the subsidence is less than when those sections are **U**-shaped. Although the foregoing statement is fairly representative for ordinary conditions, it does not apply when ships are moved at velocities very high relatively to their dimensions. In torpedo-boats, for example, the ordinary laws hold good only for the lower speeds. Mr. Thornycroft has made some valuable experiments on this matter, and a brief summary of the results may be of interest.* A boat 67 feet long was driven at various speeds, the maximum being about 19 knots; observations were made from which the vertical position of the centre of gravity and the trim of the boat could be determined at each speed. It was found that as the speed increased so the vessel sank more deeply up to about 12 knots; after which the boat rose as the speed increased. At 12 knots the bodily

* See the British Association *Reports* for 1875.

subsidence was about 5 inches, at 19 knots the bodily rise was 3 inches, these measurements being taken in relation to the still-water level. In this case the boat trimmed by the stern, as compared with her still-water trim, throughout the trials; but it must be remembered that she was driven by her own propeller, and not towed.

Experiments with models, made by Mr. Froude, have shown very similar results as regards mean draught and trim at very high speeds.* For example, a model about 10 feet long was towed at various speeds, the maximum being about 850 feet per minute—or $8\frac{1}{2}$ knots per hour. At first the trim altered very little from the still-water condition, but as the speed increased the bow gradually rose, while the stern fell. Ultimately at the maximum speed the bow had risen $2\frac{1}{2}$ inches, while the stern had sunk to an equal amount with reference to their still-water levels. This model represented a full-sized ship of 360 feet in length, and the maximum experimental speed represented a speed of more than 50 knots for the ship. The vertical displacements of the bow and stern of the ship, if moved at this very high speed, would have been more than 7 feet.

Air Resistance to the Motion of Ships.—In the actual propulsion of a ship the air exercises an appreciable resistance, especially if she is a rigged ship.

As to air resistance, there have been very few trustworthy experiments. Mr. Froude, in his experiments with the *Greyhound*, which was not rigged at the time, found that, when the speed of the wind past the ship was 15 knots per hour, it produced an effect on the hull measured by a force of 330 lbs. For other speeds of wind past the ship, it was assumed that the effect varied as the square of the speed. In the case where a ship is steaming head to wind air resistance obviously must be greatest, since the speed of the wind past the ship then equals the sum of her own speed and that of the wind. The absolute force of the air resistance in the *Greyhound* was thus found to be small; but if the vessel had been masted and rigged, the resistance would have been greater. Mr. Froude did not expressly state, in his report on this experiment, what scale of allowance he employed in estimating the additional resistance due to the passage of the masts and rigging through the air; but from the particulars which he subsequently furnished to the author, it appears that the total resistance of the masts and rigging was taken about equal to that of the hull. At a speed of 10 knots

* See the very admirable Report on published as Parliamentary Paper (No. the proposals of the Rev. C. Ramus, 313) of 1873.

through *still air*, this would give a total air resistance of about 300 lbs., the corresponding total of water resistance being about 10,200 lbs.; making the air resistance about $\frac{1}{34}$ part of the water resistance. If the ship steamed head to wind at a speed of 8 knots, the actual speed of the wind being 7 knots, it would pass the ship with a relative speed of 15 knots; the air resistance would then probably have a total of about 650 lbs., whereas (if the water were smooth) the total water resistance would be about 5600 lbs., the air resistance rising to about $\frac{1}{9}$ of the water resistance. These results may not be exactly correct, but they are sufficiently so for illustrative purposes; they explain the considerable decrease in speed in ships—especially rigged ships—steaming head to wind; and they are so considerably in excess of what would have been predicted on purely theoretical grounds as to indicate the desirability of further experiments on the air resistance to rigged ships. Up to the present time, we have little information of an exact or trustworthy character on this important subject, and probably the steady decrease of sail-power in steamships makes it less likely that much will be added to existing knowledge.

The experiments required are very simple. All that is necessary is to allow a ship to drift before the wind, to note the uniform speed which she will ultimately attain through the water, and to measure the velocity of the wind past the ship; her condition aloft must also be recorded, as to spars on-end, running rigging rove, etc. The water should be approximately smooth, and the ship should owe her drift simply to the air pressure, not to tides or currents. The resistance of the water at the uniform speed of drift must then exactly equal the total air resistance; and this water resistance could be ascertained by other experiments made either with the ship or with models. Accuracy would be increased and more valuable information obtained if the same ship were made the subject of several experiments, including two sets: one made with the same condition as to spars and rigging aloft, but with different forces of wind; the second set made with different conditions of rig, while the actual speed of the wind remained constant. This is a matter which may commend itself to the attention of naval men when they learn the imperfect condition of our present knowledge of the subject. Other modes of making the required experiments might be suggested did space permit; but it must suffice to add that, with the aid of suitable dynamometric apparatus and good anemometers, the air resistance corresponding to a certain speed of wind might be obtained with the ship moored instead of drifting.

As to the air resistance on the hull only, there appears good reason for adopting the rule which Mr. Froude suggested, viz. that

if the above-water portions of the hull are projected back upon the midship section of a ship, and the total area (A) enclosing these projections is determined, then the air resistance on that area (A) will approximately equal the air resistance on the hull for any assumed speed. In the *Greyhound* the area A was somewhat less than 400 square feet; Mr. Froude ascertained by experiment that at a speed of 1 foot per second the air resistance per square foot on a plane area is about equal to $\frac{17}{10000}$ lb. A speed of 15 knots per hour equals about $25\frac{1}{2}$ feet per second; and since the air resistance varies as the square of the speed, the speed of 15 knots should correspond to a pressure of about 1.09 lb. per square foot of area. Hence the total air resistance on the *Greyhound* for a speed of fifteen knots past the ship should be about 436 lbs. by this law; and by experiment it was determined to be 330 lbs. This approximate rule may be found useful for purposes of comparison between different types of ships; and in mastless ships it will give a fair estimate of the total air resistance at any assigned speed of wind past the ships. Rigged ships present a more difficult problem, which can be best dealt with experimentally.

Resistance when Motion is not uniform.—Throughout the preceding pages, the discussion has proceeded on the assumptions of uniform motion and still water. These are not the conditions of practice, but they are necessarily assumed for purposes of exact investigation. When motion is not uniform, but variable from moment to moment, other considerations have to be kept in view, even if the hypothesis of still water is maintained. Suppose, as before, that a ship is being towed. For uniform motion the tension on the tow-line equals the resistance. If at any moment the tension on the tow-line were increased, there would be an unbalanced force, tending to accelerate the speed of the ship. If after being increased the tension was maintained at a constant value, the ship would finally settle down to a higher speed at which the resistance once more balanced the tow-rope tension. During the interval before this balance was re-established, the motion of the ship would be accelerated. At p. 149, an explanation of the nature and mode of measuring accelerating forces has been given. It will thus be seen that, in order to estimate the acceleration of speed, it is necessary to know the weight of the ship and that of the water surrounding her whose motion is to be changed, as well as the amount of the unbalanced force tending to accelerate the motion. Mr. Froude's experiments on the *Greyhound* showed that the virtual weight of a ship in motion—that is, the sum of her own weight and that of the water influenced by her motion—might be taken at about 20 per cent. above the actual weight of the ship. If the curve of resistance of the ship for uniform motion is known,

then it is possible to trace her acceleration in velocity under the circumstances assumed, when the variation in the tow-rope tension is known. Similarly if the tow-rope tension were reduced, the retardation in speed can be traced. And if the increase or decrease of tow-rope tension varied from instant to instant according to some given law, it would still be possible, mathematically, to determine the motion of the ship.

In practice, when ships are not towed, but propelled by their own engines and propellers, circumstances commonly arise which interfere with uniform motion. Variations in the engine-power developed, changes in the depth of water, progress through tides or currents, and other causes, may produce alterations in speed even in still water. Consequently, for the scientific analysis of steam trials it is absolutely necessary to have the most detailed observations and records of facts if accuracy is to be obtained, and information gathered for future guidance. Ordinarily steam trials are not conducted in this manner, and there is often a tendency to treat scientific methods as useless refinements. For most purposes it may be admitted that rougher methods, dealing with the performances broadly on the basis of the powers developed at various speeds, suffice for practical purposes. That admission, however, in no way lessens the value of the more scientific method of inquiry, particularly for vessels of new types.

Resistance in a Seaway.—When water ceases to be smooth, the resistance it offers to the motion of a ship must obviously be affected. Observation and experiment tend to show that a very moderate degree of wave motion sensibly affects the resistance, increasing its amount for a given speed as compared with that in smooth water. In a seaway there are infinite varieties of roughness and corresponding variations in resistance, while the motions of ships in pitching and rolling also influence the speed. Under these circumstances any attempt to express the increase in resistance by an exact method must be hopeless. Experience proves, however, that for maintenance of speed in a seaway, considerable length, good freeboard, and moderate pitching are essentials. Greater size and weight give ships, other things being equal, a greater power of maintaining speed. This is established by the comparative regularity of the passages made by large ocean steamers, especially those on the Atlantic service, under very various conditions of wind and sea. In selecting the form of a new ship, particularly towards the extremities, service at sea must be kept in view no less than economical propulsion in smooth water; and it is fully recognized that some forms which would be admirable for smooth-water are not well adapted for a seaway. Experience alone can be trusted in deciding between these somewhat conflicting claims.

CHAPTER XII.

PROPULSION BY SAILS.

THE efficient management of a ship under sail furnishes one of the most notable instances of skilful seamanship. In different hands the same ship may perform very differently. Changes in stowage and trim also affect the performance; but such changes as an officer in command can make are necessarily limited in their scope and character; and some ships can never be made to sail well, having radical faults in their designs. Without intruding upon the domain of seamanship, the naval architect requires, therefore, to study very carefully the conditions of sail-power, and the distribution of sails in a new design, if the completed ship is to be fairly successful. His success or failure greatly depends upon the possession of information respecting the performances and sail-spread of ships of similar type and rig. Having such information, the process by which the total sail-spread and the distribution of the sail are determined in the new ship is by no means difficult or complex. Taking the exemplar ships, and the reports on their sailing qualities, an analysis is made of the sail areas, the distribution of the sail longitudinally and vertically, the transverse stability, and some other particulars. Furnished with these data, and having regard to the known qualities of completed ships, it is possible to secure similar, or perhaps improved, performance in the new design. Apart from experience, however, the naval architect would be unable to be equally certain of obtaining good results; and in cases where great strides are taken in new designs, away from the sizes and proportions or sail plans of existing ships, the arrangement of the sail-power cannot but be, to a large extent, experimental.

The Laws of Wind Pressure.—An acquaintance with the laws which govern the pressure of the wind on sails is obviously essential to accurate investigations of the behaviour of sailing ships. These laws have not yet been determined experimentally. Many theories have been framed for dealing with the problems involved in pro-

pulsion by sails, and deductions have been made therefrom as to the practical management of ships. None of these attempts at scientific treatment of the question has had much influence on practice. In fact, experiment and observation alone can be relied upon as a basis for scientific procedure. Up to the present time, experimental data, in regard to wind pressures on sails, are scanty. Similar experimental inquiry into the laws of wind pressure on plane and curved surfaces has been greatly advanced in recent years. As many of the results obtained have an intimate bearing on the performances of sailing ships, it is proposed to briefly summarize them.*

The simplest case to be considered is that of a thin plate placed normal to the line of motion of the wind; or the corresponding case of a thin plate moving normally to itself, and at uniform velocity through still air. All experimentalists agree that in this case the resistance, or normal pressure, varies as the square of the velocity, and may be expressed by the formula—

$$R = k \cdot A \cdot V^2.$$

where R = the normal pressure (say in pounds).

A = area of the surface of the thin plate (say in square feet).

V = relative velocity of the wind and the plate (say in feet per second).

k = a constant coefficient for the same area and form of plate; its value being experimentally determined.

The pressure (R) includes both the positive pressure on the front face of the plate, and the negative pressure at the back due to eddy-making. * A similar case for motion through water is described on p. 438.

In the following table are summarized values of the coefficient k obtained by various experimentalists on small plates, mostly of rectangular form, and not exceeding 3 to 4 square feet in area:—

* An excellent account of early experiments appears in Spon's "Dictionary of Engineering." Beaufoy's experiments are described in the "Papers on Naval Architecture" (vol. i.). Valuable information respecting wind pressures on railway structures is given in Parliamentary Paper C 3000 of 1881, and in various "Memoirs on the Forth Bridge," by Sir Benjamin Baker. Important contributions on anemometry, and experiments on wind pressure appear in the

Journals of the Royal Meteorological Society, 1882-90; and in the Proceedings of the Royal Society for 1890-91. Details of the observations made by the late Lieutenant Paris of the French Navy on board several ships, have been published in vol. xxxi. of the *Revue Maritime et Coloniale*, and in his posthumous work "Observations sur les Vitesses du Vent et du Navire"; Paris, 1885.

Experimentalist.	Date.	Value of <i>k</i> .	Mode of experiment.
Borda . . .	1763	.00184	Plates moved through still air on a revolving fan-wheel.
Thibault . . .	1832	.00206	
Morin . . .	1835	.0019	
and Didion . . .	to 1837	.0016	Plate falling vertically.
Beaufoy . . .	—	.00207	Plate exposed to wind.
Rouse . . .	—	.00229	
Hutton . . .	—	.00188	
Paris . . .	1872	.00224	Plates exposed to wind for pressure; anemometric observations for speed.
	to 1880	to .00239	
Froude . . .	1876	.0017	Plate moved through still air in straight line at uniform speed.
Dines . . .	1888-90	.00135	Plate moved through still air on a specially designed "whirling" machine.

1893
1913

The earliest experimental information on this subject was obtained by the French. Morin and Didion used delicate chronometric apparatus; and it is interesting to note that their results agree very closely with those obtained by Mr. Froude, who made his experiments under more favourable conditions than other experimentalists, so far as stillness of the air and uniformity of motion are concerned. Mr. Dines' experiments were conducted on a "whirling" machine in the open air, and are probably the best experiments of that kind yet made. At the same time, it is obvious that when plates are moved rapidly round on a "whirler," there is a possibility of the air being acted upon by the apparatus, and the results being somewhat influenced by such action. This is clearly recognized in the account of the experiments, and may explain the lesser values of *k* as compared with the results of Mr. Froude, where the plate was moved rectilinearly through still air. According to the latest experiments of Mr. Dines, a pressure of 1 lb. per square foot corresponds to a relative velocity of wind and plate of 27½ feet per second, or about 18½ statute miles, and about 16 knots per hour. His earlier results gave a velocity of rather over 17 miles per hour. Mr. Froude gave 24½ feet per second as the corresponding velocity, which gives 14½ knots, or about 16½ statute miles per hour. On the whole it is considered that the last-mentioned result is the most trustworthy. The two sets of experiments may be expressed as follows: if *v* be the velocity of wind in statute miles per hour—

(Froude) Pressure on plate (in pounds) = .00366 × area (in square feet) × *v*²
 (Dines) " " " = .0029 × area (in square feet) × *v*²

These formulæ may be compared with that proposed by the committee appointed by the Board of Trade subsequently to the Tay Bridge disaster. It runs as follows:—

If $P = \text{maximum pressure}$ in pounds on the square foot occurring during the storm to which v refers.

$v = \text{maximum run}$ of the wind in any one hour, measured in statute miles by an anemometer.

$$\text{Then } P = \cdot 01v^2.$$

This will be seen to be about three times the pressure which would be given by the mean of the foregoing coefficients based on the experiments of Froude and Dines. It must be noted, however, that the Committee contemplated a varying velocity of wind, and endeavoured to express the maximum velocity and corresponding pressure in terms of the hourly run, which would average these alternations of velocity. The other formulæ refer to uniform velocity of wind.

The values of k in the table given by Lieutenant Paris, as the result of his observations on board ships, are relatively high. It is probable that this arose from unavoidable difficulties to which attention was called by Lieutenant Paris himself. The presence of rigging and sails necessarily produced eddies and currents of wind in the neighbourhood of the ship. No place of observation could be found, therefore, where measurements of the true velocities and pressures of winds could be made; and as regards velocities, the anemometric records which were adopted are open to doubt. Notwithstanding these limitations, the work done by Lieutenant Paris is of the greatest interest, and is unapproached by that done by any other observer under similar circumstances.

The preceding formulæ require correction when it is desired to obtain the pressures on *plates of large area* exposed to winds of certain velocities. It has been remarked that the values of k given above were determined experimentally for small pressure plates, and until recently direct experiments had not been made with large pressure plates. Experience had shown, however, that when the wind acts upon a large surface, there are gusts and currents of varying velocity on various parts of the surface. Further, the fact that certain structures had successfully withstood great storms of wind afforded positive proof that the mean pressures per unit of area were much less than those corresponding to the maximum velocities indicated by small anemometers during the same storms. These anemometers may have been acted upon by "streams" in the wind currents, for which the velocities exceeded the mean velocities of the currents taken over the whole areas. In many instances the

situation and surroundings of the anemometers have affected their indications, and in others there have been obvious errors in the recording apparatus. On the whole, however, the broad conclusion based upon experience was that, for a given velocity of wind, large areas sustained a smaller pressure per square foot than smaller areas. Some of the earlier writers on propulsion by sails also recognized the fact that variations in the sizes and shapes of sails affected their propelling power, and various speculative explanations were given of the circumstance. To these theories, however, it is unnecessary to allude further. Direct experiments have been made on this subject in recent years. Those on the largest scale have been carried out at the Forth Bridge, and the results are most interesting.* Three pressure boards were erected. One was twenty feet long by 15 feet high; the other two were circular plates each of $1\frac{1}{2}$ square feet in area. From a long series of records, it was concluded that the effective pressure per square foot on the large board averaged only about *two-thirds* the pressure indicated by the small and light plates. For instance, when the latter indicated 41 lbs. per square foot, the large board did not indicate more than 27 lbs., and in one case it indicated only 15 lbs. Other observations showed conclusively that the streams of maximum velocity and pressure in a wind current are of a limited extent and local in character, and that the mean velocity of the current is much below that maximum.

Experiments subsequently made by Mr. Dines confirm the conclusions reached in the Forth Bridge experiments. Three boards were used: one, 6 feet by 7 feet; a second, 3 feet square; and a third, $1\frac{1}{2}$ feet square. The respective areas were 42, 9, and $2\frac{1}{4}$ square feet. Calling the pressure per square foot on the smallest board 100, that on the next larger was 89, while the corresponding pressure on the largest board was 78. The law of diminution of pressure per square foot with increase in area has not yet been determined. For that purpose further experiments are necessary. It has been established that the *proportion of perimeter to area* in a thin plate affects the mean pressure. This was supposed to be the case by some of the earlier writers on propulsion by sails. Mr. Dines proved experimentally that increase in perimeter, with a constant area, is accompanied by increase in mean pressure. One of his experiments is very interesting. Two rectangular plates were taken, each 48 inches long by 3 inches wide, the area of each being 1 square foot, and the perimeter 102 inches. For a certain velocity

* See Sir Benjamin Baker's "Memoir" *Engineering* of February 28, 1890. For in the British Association Reports for 1885, and the later records published in Mr. Dines' experiments, see *Journal* of the Royal Meteorological Society for 1890.

of wind, the pressures on these plates were ascertained: first, when they were so distant from one another as to have no mutual influence; second, when the two plates were placed with their adjacent long edges in contact, forming a plate 2 square feet in area, and with a perimeter of only 108 inches. In the second case the total pressure was less than 80 per cent. that in the first.

Experiments have been made also on thin plates of the same area, but different forms. These changes in form, of course, affect the proportion of perimeter to area, and so influence mean pressure. Up to the present time only small-scale experiments have been made, and the subject is deserving of further investigation. It will be obvious that it has an important bearing on the relative value of sails of different shapes, particularly as between that class of sails which are approximately triangular, and those which are approximately rectangular.

Closely related to the foregoing investigations are those which have been made in order to determine the movements of wind currents when they impinge normally upon thin plates, and the consequent distribution of pressure over the surfaces of the plates. Mr. R. H. Curtis has done good work in this direction, experimenting with boards from 1 square foot in area up to 16 square feet.* On each board holes were formed in a series of selected positions, one being in the centre, and used as a standard. By means of tubes, the centre hole and any other hole could be connected simultaneously to pressure-gauge glasses containing water. Changes of level in the glasses gave the relative pressures of the wind on the front of the plate, at the centre, and at the selected hole. A series of observations gave corresponding results for all the holes, and so determined the distribution of pressure. These results may not be absolute indications of what happens in an unperforated plate, but the errors ought not to be large, and the general conclusions are interesting. The pressure gradually diminished in intensity from the centre towards the edges of the boards. For square boards of the different sizes tried, the law of distribution was approximately the same. A board having a side of $2\frac{1}{2}$ feet and an area of $6\frac{1}{4}$ feet may be taken as an example. Calling the pressure at the centre 100, that at a point about midway between the centre and the edge was 90; at a point 13 inches from the centre it was 80; and close to the edge about 70. For a circular board 2 square feet in area, the pressure at the centre being 100, that on a circle having a radius equal to one-half the radius of the board was 90; for a radius 70.

* See *Journals* of the Royal Meteorological Society for 1882-83.

per cent. of the radius of the board the pressure was 70; and for a radius 85 per cent. of the radius of the board it was 60. These reductions of pressure towards the edges, no doubt, result from the deflection of the wind currents from the centre over the front surface of the plate.

Mr. Dines has approximated to the pressure experienced at the centre of the front of a board 1 foot square, and the simultaneous negative pressure at the centre of the back surface. For a velocity of wind of 60 miles per hour, he made the front pressure equivalent to 1.82 inch of water, and the negative pressure to 0.89 inch. The sum of these (2.71 inches of water) represents about 14 lbs. per square foot. For this velocity of wind, the total pressure on a plate 1 foot square, according to independent experiments made by Mr. Dines, would be about $10\frac{1}{2}$ lbs., or about 75 per cent. of the maximum pressure at the centre. This is a practical confirmation of the preceding results.

In the Forth Bridge observations, two small pressure gauges were arranged in connection with the large pressure board. One was at the centre, one near a corner of the board. The indications of the small gauge at the centre were always in excess of the simultaneous indications of the corner gauge, but the proportions varied greatly. Calling the indication at the centre 100, that at the corner varied from 77 to 93.6. The mean of the indications of the small gauges exceeded the mean pressure per square foot over the whole area of the large board, which varied in the cases mentioned from 66 to 85.

The effective wind pressure on the total area of the sail set on a ship must obviously be affected by the mutual influence of adjacent sails. That influence depends upon the relative positions of the sails and the spaces between them. The direction of the wind, its velocity, and the speed and course of the ship also affect it. Different styles of rig must be differently affected. To these general statements there can be no objection; but there is little exact information respecting the actual effective wind pressures on the sails of ships of different classes under different conditions of sailing, or the influence of adjacent sails upon one another.

Experiments made with plates, like those mentioned on p. 495, are suggestive of the results which may follow from variations in the distances between the edges of adjacent sails, especially with fore-and-aft rig. Supposing the two plates there mentioned to experience a total pressure of 100 when placed 6 inches apart (twice their own width), that pressure fell to 91 when the edges were only 1 inch apart, and to 79 when the edges were in contact. A plate 7 inches wide would have experienced about the same pressure as

these two plates, each 3 inches wide, with an open space of 1 inch between the edges.

In square-rigged ships, portions of the sail set are necessarily to windward of adjacent sails, and consequently affect the pressure upon those sails. The distance apart of the two sets of sail is an important matter in such cases. Here also there is room for further investigation. In connection with bridge construction, and more particularly with the Forth Bridge, many experiments have been made to determine the pressure on a series of girders placed parallel to one another or nearly so, and associated with horizontal platforms. The results are of great interest, but limits of space prevent any details being given. It has been shown, however, that problems which could not be solved by mathematical investigation are readily dealt with experimentally. This conclusion applies equally to the case stated above for adjacent sails.

Wind Pressures on Oblique Plates.—When the wind impinges on a flat plate set obliquely to its direction of motion, the normal pressure is less for nearly all positions than it is when the plate is placed at right angles to the line of motion. Various mathematical formulæ have been devised for calculating these normal pressures, resembling in form those given on p. 440. Experiments have also been made in order to determine these pressures. Thibault made the most elaborate experiments of the kind amongst the earlier inquirers. Mr. Dines has in recent years gone much beyond what was previously accomplished. In Fig. 152 are shown four curves. Abscissæ measurements correspond to the angles of inclination of the plate

FIG. 152.

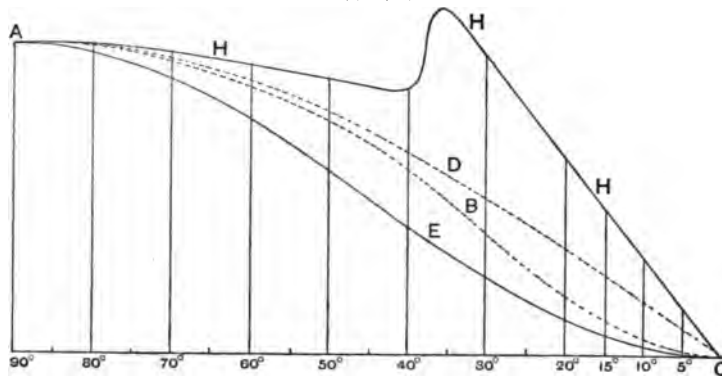

to the direction of motion of the wind. Ordinates to the curves represent the corresponding normal pressures on the plate. The curve ADC represents the assumption that the normal pressure varies as the sine of the angle of inclination; the curve AEC

represents the assumption that it varies as the square of the sine. The curve ABC shows Thibault's experimental results; that marked AHC shows Mr. Dines's. The last-mentioned is very peculiar in character, and differs altogether from Thibault's. Mr. Dines applied various independent tests, but the same character of curve (and particularly the very curious and sudden rise between 40 and 35 degrees of inclination) occurred in all cases.* If these latest results be accepted, as there seems good reason to do, then all previous estimates of effective normal pressures for angles of inclination of plates to the line of motion of wind up to 35 to 40 degrees are shown to be much below the truth. At 30 degrees, for example, Thibault's results are only 40 per cent. of Mr. Dines's; at 20 degrees, 30 per cent.; and at 15 degrees, 25 per cent.

The matter is one of considerable practical interest, especially in connection with the behaviour of sailing vessels when "close-hauled" to the wind, both as regards the speeds attained and the angles of heel produced by wind pressure. In a square-rigged ship, for example, sailing as close to the wind as possible, the angle which the apparent wind makes with the sails may be as low as 15 degrees, and the normal pressure deduced from the latest experiments would then be about *four times* as great as the previously accepted rules would indicate. The propulsive and heeling effects of the normal pressures would be correspondingly increased.

In the case of a plate set obliquely to its line of motion through water, it has been explained that the centre of pressure is nearer the leading edge than the after edge (see p. 439). Similar conditions hold good in plates on which winds act obliquely. More than one experimentalist has dealt with this matter, but Mr. Dines has most thoroughly investigated it. Taking his experiments made on a pivoted plate 1 foot square exposed to the action of wind, he found the centre of pressure was three-tenths of a foot from the leading edge for an inclination of 10 degrees, three-eighths of a foot for 20 degrees, and four-tenths for 30 degrees. The centre of pressure was before the middle of the plate, but at a gradually diminishing distance up to the time when the plate was placed normal to the wind.

Mr. Curtis, in the series of observations above described, placed a board 1 foot square at an angle of 45 degrees to the direction of the wind. Calling the standard pressure at the centre hole on the board 10, the corresponding pressure at three-fourths the distance from the centre towards the windward edge was found to be 13, while that correspondingly placed to leeward was 6.4.

Wind Pressure on Curved Surfaces and Sails.—In the course of

* See *Proceedings of Royal Society* for 1890, No. 294.

his experiments (about 1832) Thibault attached small sails (about 1.2 square foot in area) to the arms of a fan-wheel, noting the resistances when they were tightly stretched as planes, and when they were allowed to "belly out" under the action of the air. Such small-scale experiments, of course, are no safe guide when applied to the enormously greater areas of the sails in a ship. So far as he went, Thibault concluded that the normal pressure on a curved sail was equal to that on a plane sail of the same shape and area. The effect of the curvature appeared to balance the reduction of the area when projected on a plane normal to the wind.

Mr. Dines has experimented on curved sheets of metal, cylindrical in form, which, when laid flat, were of square form with an area of 1 square foot. These bent plates had their axes inclined to the wind at various angles, and their curvature was varied in different experiments.* They were tested with the concave and convex surfaces facing the wind. In this connection interest is limited to the former case, which corresponds to a sail "bellied" out.

Taking the case of normal incidence, the plate was tried first as a plane, and then with varying curvatures. The projected area of the plate upon a plane perpendicular to the wind direction, of course, decreases as the curvature increases. In these experiments the depth remained constant, so that the plate which was square when flat had a narrowing rectangular projection as the curvature was increased. This fact should be kept in view when examining the following experimental results—

Chord. inches.	Versine. inches.	Area of projec- tion square foot.	Relative pressure per square foot.
12.0	0.0	1.0	114
11.8	1.0	0.98	129
11.6	1.5	0.97	130
10.9	2.0	0.91	127
9.0	3.3	0.75	129

These figures are interesting when compared with Thibault's conclusion stated above.

Further experiments were made with the axes of the curved plates inclined to the wind. For these oblique positions, such changes in curvature as were tried, did not appear to have a very marked influence upon the normal components of the wind pressure. The range of curvature was not a large one, and for such changes as were made in curvature the difficulty of carrying out the experiments increased as the inclinations of the axes of the cylinders to the direction of the wind became smaller. Under these conditions the plates

* See *Proceedings* of Royal Society for 1891, No. 302.

had considerable vibratory motions, which sometimes tore them. This phenomenon is of interest in connection with the behaviour of sails in ships sailing close to the wind or "going about."

As regards the effect of changes in inclination to the wind of curved plates when the curvature remains constant, these experiments indicated that the normal components of the wind pressure remained almost constant in value from normal incidence up to 40 degrees departure therefrom. As the departure from normal incidence increased, the normal components first diminished slowly, and then at 55 to 60 degrees of departure increased rapidly, as shown for the same angles on the curve AHC in Fig. 152. Subsequently the curve rapidly dropped, but for very small angles of inclination its character was not determined, for the reasons stated above.

None of these experiments on curved plates or sails are on a scale sufficient for making trustworthy estimates for the pressures on large sails. Experience appears to show, however, that the more nearly plane the surfaces of sails can be kept the greater will be the propelling force of the wind pressure. The opinions of naval officers in the days of sailing war-ships were summed up by Mr. Fincham as follows: "All slack canvas, whether sailing by the wind or large, lessens the effect of the sail. Even before the wind, when the slack reef is out the power which acts on the sail will be reduced very considerably on the curved surface; less even than the base of the same curve, or than if the sail were set 'taut-up,' but reduced to the same 'hoist' (or distance between the yards) as when slack."

Reviewing the foregoing sketch of the laws of wind pressure, it must be admitted that much remains to be ascertained, although much valuable information has been recorded for thin plates and certain solid bodies. Accurate knowledge of the laws which govern wind pressures on large sails is almost entirely wanting. We cannot certainly express the pressure per unit of area on large sails corresponding to a given velocity of wind and to a certain angle of incidence; and need further experiments on a larger scale, accompanied by more accurate observations than are now common, respecting the velocity and pressure of the wind. Such experiments would be by no means difficult to arrange, and they could be best conducted on board small sailing vessels, such as yachts, of which the stability had been ascertained by experiment and calculation. It would be necessary to place the vessel beam-on to the wind, to hoist certain sails, and to note the corresponding angles of steady heel. By means of anemometers, the velocity and pressure (on small areas) could be measured simultaneously, and the average pressure per unit of area on the sail set could be deduced from the righting moment due to the observed angle of heel. The areas and forms of

the sails set could be varied, and thus much valuable information could be obtained.*

Classification of Winds.—It is usual to classify winds by their velocities, and by certain numerals indicating their "force." These velocities, for the most part, have been measured by revolving anemometers, with radial arms carrying cups. It was estimated by Dr. Robinson, who introduced this instrument, that the rate of rotation of the cups was *one-third* that of the wind. Later experiments, conducted by Dr. Robinson himself and by other experimentalists, have shown that there is no constant relation between the rate of motion of the cups and the velocity of the wind. That relation varies with differences in the construction of the instrument, in the sizes of the cups, and the lengths of the arms, as well as with variations in the speed of the wind, especially in the form of gusts. According to the latest and best experiments, the value 3, originally assigned as the factor for multiplying the speed of the cups in order to obtain the speed of the wind, is much too high for anemometers of the Kew pattern, the mean value deduced being 2·17.† Hence it results that the recorded velocities for winds measured by anemometers according to the old scale are considerably above the truth.

The positions in which anemometers are placed, and their surroundings, influence the currents of air impinging upon them, and probably account for some high readings. Moreover, as already stated (see p. 495), it is a well-known fact that in a wind current there are "streams" having velocities greatly exceeding the mean velocity of the wind over a large sectional area of the current. In records of maximum velocity measured by anemometers, all these causes of exaggeration may be in operation, and sometimes the recording apparatus is of a character that will still further exaggerate the true velocity, especially in gusts of wind.

It has been usual hitherto to accept the following classification for winds, proposed by Admiral Beaufort, and known as the "Beaufort Scale": "Hurricane" (Force 12), speed assigned 60 to 100 knots per hour. "Storm wind" (Force 11), speed 45 to 50 knots an hour. "Heavy gale" (Force 10), speed about 40 knots. "Strong gale" (Force 9), speed about 34 knots. "Fresh gale" (Force 8), speed about 28 knots. "Moderate gale" (Force 7), speed about 23 knots. "Strong breeze" (Force 6), speed 15 to 20 knots. "Fresh

* This recommendation was made by the author in 1881. About 1889-90 the late Professor Jenkins consulted the author as to the prosecution of these experiments, and it is understood that he actually made some progress with

them during a yachting cruise. No results have been published, and his death caused a suspension of the work.

† See Reports of Wind Force Committee in *Journal of Meteorological Society* for 1888 and 1890.

breeze" (Force 5), speed of about 14 knots. For the highest forces of wind the velocities are possibly over-estimated. If they were accepted, the pressures per square foot on plates placed at right angles to the wind would be very great, rising to about 50 lbs. per square foot for a hurricane. There are, it is true, anemometric records of velocities varying from 60 to 100 knots; these are probably in excess of the truth, for reasons given above.

For engineering purposes, when dealing with the strength and stability of structures, measurements of pressure are more important than measurements of velocity. The Board of Trade Committee, to which allusion has been made, refer to wind pressures of 80 or 90 lbs. per square foot having been noted in this country under exceptional circumstances, and treat 50 to 60 lbs. as unusually high pressures. Their recommendation was to use 56 lbs. per square foot as a maximum wind pressure in calculations for railway bridges and viaducts. Probably the extraordinary pressures mentioned by the committee were not observed in such a manner as to command acceptance, since the velocities corresponding to 90 lbs. per square foot would be from 150 to 170 miles per hour by the formulæ given on p. 493. Taking the observations made at the Forth Bridge from 1883 to 1892, with which we have been favoured by Sir Benjamin Baker, the maximum pressure recorded on a small board has been 41 lbs. per square foot, and on the large board 35 lbs. per square foot, corresponding by the formulæ to mean velocities of from 100 to 120 miles per hour. The recommendation of the committee was therefore considerably on the side of safety.

For nautical purposes it is usual to classify winds by the amount of canvas which a well-found sailing ship could carry with the respective forces of wind, such as "topgallant-sail wind," "topsail wind," "reefed topsail wind," "close reefed topsail wind," etc. It is commonly assumed that the "topgallant-sail wind," when all "plain sail" is carried on a ship-rigged vessel, corresponds to the "fresh breeze" (Force 5), and to 1 lb. pressure per square foot on a plate placed normally to it. There does not appear to be any absolute proof that this assumption is correct, but it is based on experience, and has many advantages as a working hypothesis in dealing with plans of sails.

The Propulsive Effect of Wind on Sails.—Sails attached to ships are not fixed in position like the plates and sails considered above, but necessarily move with the ship. Hence, in dealing with the propulsive effect of a wind of which the absolute direction and force are known, it is necessary to take account also of the motion of the ship; or, as it is usually expressed, it is necessary to determine the *apparent* direction and velocity of the wind. This can be done

easily in any case for which the course and speed of the ship, as well as the true direction and velocity of the wind, are known, the simple general principle being that the apparent motion of the wind is the resultant of the actual motion of the wind, and a motion equal and opposite to that of the ship. A vane at the mast-head would indicate the apparent direction of the wind, and not its true direction; an anemometer on board would measure the apparent velocity of the wind.

Take the simplest case: a vessel with a single square sail running "dead before" the wind. If the speed of the wind is V feet per second, and that of the ship v , as the direction of both motions is identical, the resultant of the actual speed of the wind and the reversed motion of the ship will be $V - v$ feet; and this apparent motion will govern the propulsive effect. For example, let the speed of the wind be 15 feet per second; that of the ship 5 feet per second; the apparent speed of the wind will be 10 feet ($15 - 5$); and, accepting the coefficient given by Froude's experiments for impact on small planes, the normal pressure per square foot of area of sail will be given by the equation—

$$\text{Pressure} = \frac{17}{10000} \times 10^2 = \frac{17}{100} \text{ lb.}$$

The pressure of this wind on a *fixed* sail would be about $2\frac{1}{4}$ times as great. From this simple illustration it will be seen that it is most important to determine accurately the apparent motion of the wind.

As a second illustration, take the case of a vessel sailing on a wind close hauled, with the wind *before* the beam. To simplify matters, let a single square sail be considered set on the yard marked XY in Fig. 153. AB represents the middle line of the ship, the outline of the "plan" being indicated. The line WW_1 represents the *actual* direction of the wind; let MW_1 represent (on a certain scale of feet) its velocity. The line CC shows the course of the ship, including the effect of "lee-way"; and on W_1D (which is drawn parallel to CC) a length W_1D is set off to represent a motion equal and opposite to

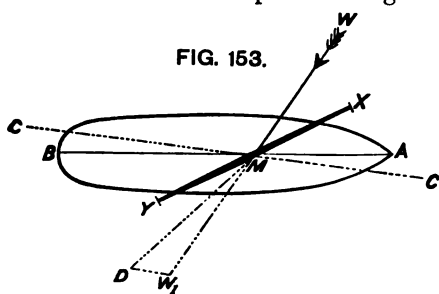

that of the ship, the same scale being used for W_1D as was employed for the length MW_1 . Join MD ; then MD represents in magnitude and direction the apparent velocity of the wind. MD is *greater* than the actual velocity MW_1 ; but its direction makes a *more acute angle* with the sail on XY than does the actual direction WW_1 .

The case of a ship sailing with the wind abaft the beam is illustrated in Fig. 154; the reference letters being similar to those in Fig. 153, no description is needed. Here the resultant MD is less than the actual velocity MW_1 ; but, as in the previous case, it makes a more acute angle with the sail on XY .

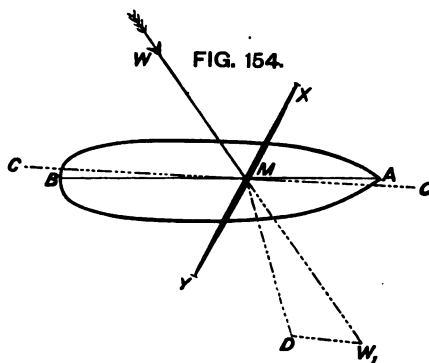

With these two examples before him, the reader will have no difficulty in readily determining the apparent velocity and direction of the wind, corresponding to observed actual speeds and directions of the wind, and observed speeds of a ship on a certain course. But this is by no means a complete solution of the question which presents itself in practice, and takes the form: Given a certain actual direction and speed of wind, and the sail area and angle of bracing for the yards, what will be the course of the ship, and her speed of advance? To answer the question fully and correctly requires *data* beyond those at present possessed, but an approximate solution is possible.

Reverting to the case of a ship sailing on a wind (Fig. 153), suppose the apparent direction and speed of the wind to have been determined. Assume EM , Fig.

155, to represent the apparent direction and force of the wind, and FM to be the normal pressure on the sail. The normal pressure (as explained above and illustrated in Fig. 152) varies

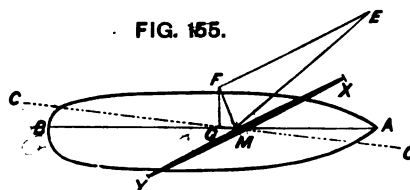

with the value of EM and with the angle of incidence; it can only be determined experimentally. The pressure FM may be regarded as made up of three pressures: one of these (shown by GM) acts longitudinally; the other (FG) acts athwartships; and the third acts vertically, at right angles to the other two, which act horizontally. For moderate angles of steady heel under sail, such as are common in ships, the vertical component of the normal pressure is not of much importance, and it is usually neglected. In all cases, however, it tends to increase the immersion of a ship; and in some cases, when the angle of heel is considerable, this effect may be noteworthy. Let it be assumed for the present that only the horizontal components FG and GM require to be considered.

When the motion of the vessel has become uniform under the action of a wind of constant force and unchanging direction, it will take place along some line, such as CC, lying obliquely to her middle line AB. This motion may be resolved into two parts: one, a direct advance in the line AB, the other a drift to leeward perpendicularly to AB. The angle made by the line CC with the keel-line AB is called the "angle of leeway." Its magnitude depends upon the ratio of the velocity of advance, or headway, along AB to the velocity of drift or leeway, and these velocities are governed by varying conditions.

If a ship were running before the wind there would be no leeway, and her motion would closely resemble that described in the previous chapter, the effective wind pressure taking the place of the tow-rope, but being applied at a considerable height. Hence, when the motion has become uniform, the wind pressure will be opposed by an equal and opposite fluid resistance, and these forces will form a mechanical couple tending to change the trim, as was previously explained. The actual change of trim would, however, be small in most cases. For instance, in the *Greyhound* running dead before the wind at a speed of 6 knots, the resistance would be about $1\frac{1}{2}$ tons, the moment of the couple less than 100 foot-tons, and the change of trim less than one inch.

As a second extreme case, suppose a ship to have her sails braced fore-and-aft, with wind abeam, and to drift bodily to leeward, moving parallel to her original position, and making no headway. When uniform speed of drift has been obtained, a lateral resistance would be developed equal and opposite to the effective wind-pressure, and forming with it a mechanical couple, causing the ship to heel. This lateral resistance, for a given speed of drift, is obviously much greater than the resistance to headway at the same speed. The ratio of the two resistances may vary greatly in different classes of ships; on account of differences in form or draught, or in the areas of keels, deadwoods, and other approximately flat surfaces immersed. Such surfaces experience a lateral resistance resembling that offered to plane surfaces moving parallel to themselves, and are, therefore, very effective in checking leeway. The curved and approximately cylindrical portions of the bottom of a ship permit the particles of water to glide past them with less abrupt changes of motion, and therefore contribute less to the lateral resistance. Exact measures of that resistance have not been determined, similar to the measures for head-resistance described in the preceding chapter. Speaking generally, it is necessary for efficiency under sail, and weatherliness, that there should be considerable lateral resistance; and in some classes of ships various devices are employed in order to increase the

lateral resistance, and to diminish leeway. In shallow-draught or flat-bottomed vessels, "lee-boards" are often fitted; these boards can be dropped at the sides of the vessels, and made to project beyond the bottom. Sliding keels, or "centre-boards," are sometimes fitted so as to be housed in recesses formed within the vessels, or to be lowered below the bottom. Very deep keels and great rise of floor are also commonly adopted in yachts designed for racing, for the same purpose.

A rough approximation is sometimes used for comparing the lateral resistances of ships of similar form, by assuming that those resistances are proportional to the resistances which would be experienced by the immersed parts of their longitudinal middle-line planes if they were moved to leeward at certain speeds. This method of procedure can only be applied within the limits named, because two ships having the same area of middle-line plane might differ greatly in fineness of form, areas of keel, etc., and so have very different lateral resistances. A more trustworthy method of estimation consists in finding the aggregate areas of the keels, deadwoods, and other approximately flat surfaces, and calculating their resistances by the formulæ given on p. 439; while the remaining portions of the wetted surface would have their resistances estimated according to the formula for frictional resistance on p. 443. But even this mode of estimating lateral resistance can be treated only as approximate, not as exact.

The conditions of actual practice in sailing ships lie between the two hypothetical cases, above described, of no leeway and no headway. A sailing ship proceeding at uniform speed under certain conditions of wind and sail-spread, usually follows a course making an angle of leeway with her keel-line, and in doing so both heels and changes trim. From what has been said above, it will be seen that *a priori* estimates of the angle of leeway for a given ship and a certain set of conditions cannot be made with certainty. Experience shows that in successful ships the angle of leeway is seldom much more than 6 degrees, and rarely exceeds 12 degrees; in less successful ships, or shallow-draught vessels with no drop-keels, the angle of leeway may be much greater.

The tangent of the angle of leeway (AMC, in Fig. 155) equals the ratio of the speed of drift to the speed ahead. These speeds depend upon various conditions, some of which have been mentioned. It will be evident, for example, that variations in the angle (AMX) to which the yards are braced will affect both the absolute and the relative values of the transverse and longitudinal components of the wind pressure. If the normal pressure (FM) were known, we should have—

$$\frac{\text{Transverse pressure}}{\text{Longitudinal pressure}} = \frac{FG}{GM} = \cot AMX.$$

Suppose $AMX = 30$ degrees ; then—

$$\text{Transverse pressure} = \text{longitudinal pressure} \sqrt{3}.$$

The speeds ahead and to leeward clearly do not depend simply upon this ratio of the longitudinal to the transverse wind pressures ; they are governed far more by the relative resistances of the water to the motion of the ship ahead and to leeward. Even if the two pressures were exactly equal, the resistance to leeway would be much greater than the resistance to headway, and the speed of advance would much exceed the speed of drift. Moreover, it must be noted that the magnitude and direction of the fluid resistance are affected by the action of the wind upon the sails. Heeling destroys that symmetry of form in the immersed part of the ship which exists when she is upright ; and thus the character of the stream-line motions is changed from that considered in the preceding chapter. Change of trim may also affect the resistance somewhat, but probably not to so serious an extent as heeling. Leeway, again, causes the vessel to move obliquely through the water, instead of along her line of keel ; and this oblique motion not merely involves additional resistance, but leads to an unequal distribution of the dynamical pressures on the leeward side. The most intense pressures are experienced on the lee bow, and this effect is enhanced by the heeling ; so that the tendency is to make the bow "fly up into the wind." From this brief statement it will appear, therefore, that any exact determination of the speed and course as well as magnitude and direction of the fluid resistance experienced by a sailing ship is scarcely to be hoped for ; even when the force and direction of the wind, the spread of sail and bracing of the yards, are assumed to be given. But it will also be obvious that in every case when uniform motion has been attained on a certain course, the longitudinal and transverse components of the fluid resistance will balance respectively the corresponding components of the effective wind pressure.

Confining attention for the moment to the longitudinal components, it will be evident that if the component of the effective wind pressure exceeds the corresponding component of the resistance, the velocity of headway will be accelerated. Reverting to Figs. 153 and 155, it will be seen that this increase in speed must affect both the direction and velocity of the apparent wind, and so influence the value of the longitudinal component of the effective wind pressure. But so long as GM , Fig. 155, exceeds the longitudinal component

of the resistance, so long will the speed be increased. If the resistance is small even at very high speeds, then it is theoretically possible for a vessel sailing on a wind to attain a speed exceeding that of the wind. In ice boats this condition is realized. There is practically no leeway, and the frictional resistance of the sledge or "runner" on which the boats run is exceedingly small even at high speed. With the wind varying from a point before the beam to an equal amount abaft the beam, speeds are said to have been reached about equal to twice the real velocity of the wind.

When a ship, sailing at a uniform speed, under the action of a wind of which the force and direction are constant, maintains an unchanged course without the use of the rudder, it is clear that the resultant pressure of the wind on the sails and the resultant resistance of the water cannot form a couple tending to turn the vessel. Under these circumstances, therefore, these equal and opposite forces must act in the same vertical plane. If it were possible to determine the line of action of the resultant resistance for any assumed speed, on a certain course in relation to the direction of the wind, then it would follow that the sails should be so trimmed as to bring the line of action of the resultant wind pressure into the same vertical plane with the resultant resistance, if the course is to be maintained without the use of the rudder. The less the rudder is used in maintaining the course, the less will the speed of the ship be checked thereby. In practice, however, the theoretical conditions cannot be fulfilled, because the line of action of the resultant resistance cannot be determined in the present state of our knowledge, even under given conditions of speed and course; because that line of action changes its position with changes in the speed, the angle of leeway, and the transverse inclination of the ship, not to mention the changes consequent on the alterations in the force and direction of the wind; and because it is not possible to determine accurately the line of action of the resultant wind pressure on the sails, when set in any given position. The problem which thus baffles theory is, however, solved more or less completely in practice. The skilful seaman varies the spread and adjustment of his sails in order to meet the changes in the line of action of the resistance. In a well-designed vessel, the distribution of the sail is such that the commanding officer has sufficient control over her movements under all circumstances. Some vessels, however, are not so well arranged for sailing purposes, and in them "ardency" or "slackness" when sailing on a wind may be practically incurable.

"Ardency" is the term applied when a vessel tends to bring her head up to the wind, and she can only be kept on her course by keeping the helm a-weather; the resultant resistance must then act

before the resultant wind pressure. The contrary condition, where the resultant resistance acts abaft the resultant wind pressure, and makes the head of the ship fall off from the wind, is termed "slackness," and can only be counteracted by keeping the helm a-lee. Of the two faults, slackness is regarded as the more serious; for a vessel thus affected seldom proves weatherly. To avoid excess in either direction, the naval architect distributes the sails of a new ship, in the longitudinal sense, by comparison with the arrangements in tried and successful vessels, conforming to some simple rules which will be stated hereafter.

From the foregoing explanations, it will appear that the greatest care must be taken in determining the angle to which the yards shall be braced, or the sails set, in order to secure the greatest speed when sailing on a wind. This is pre-eminently a question of seamanship; but it has engaged the attention of many eminent mathematicians, whose investigations remain on record. All these investigations were based upon certain assumptions, as to the effective pressure of a wind acting obliquely upon the sails, the apparent direction and velocity of that wind being known. In Fig. 155, for example, if EM represents in direction and magnitude the "pressure due to the apparent velocity" of the wind—that is, the pressure it would deliver upon a plane area, say, of one square foot placed at right angles to EM —the effective pressure (FM) would, according to the law formerly received, have been expressed by $EM \sin^2 EMX$. It has been shown that this law cannot be accepted; and therefore the elaborate deductions which have been made from investigations based upon it have now little interest. Even if the true law were determined, mathematical inquiries could never be trusted to replace the judgment of the sailor in determining the most efficient angle for bracing the yards or trimming the sails. So many varying circumstances have to be encountered in the navigation of a sailing vessel that theory can never be expected to take complete cognisance of them all. The decision as to the best mode of handling a sailing ship must rest, where it has always rested, in the hands of her commander.

It will be seen, from the foregoing explanations, that when ships are sailing close hauled it is of very great importance to be able to bring the sails to comparatively small angles with the line of keel. In this respect square-rigged vessels compare unfavourably with fore-and-aft rigged vessels, since the bracing of the yards in the former has practical limits imposed upon it by the presence of shrouds, stays, etc. In yachts the "feet" of the sails are said to seldom exceed an angle of 10 degrees with the keel when sailing close hauled. In fore-and-aft rigged vessels, such as formerly existed in

the Royal Navy, the corresponding angle was from 13 to 17 degrees. It is to be observed, however, that for all fore-and-aft sails not set on a stay, the angle at the foot is less than that at the head; for fore-sails, jibs, etc., set on stays the converse is true. In square-rigged ships sailing close hauled the yards are seldom braced more sharply than 25 to 30 degrees with the keel, when ordinary arrangements of shrouds and stays are fitted. Some vessels, including the ill-fated *Captain*, have had specially contrived tripod supports, partly for the purpose of increasing the power of bracing up sharply. Experience proved that such sharper bracing was advantageous. One example may be given from the experimental squadron of 1827.* Most of the vessels tried could only brace their yards up to 27 or 30 degrees. One vessel could brace up to 17 or 19 degrees, and proved very superior on this point of sailing, although she had the least relative length. The other ships could only lie within $5\frac{1}{2}$ points of the wind, whereas this vessel could lie within $\bar{5}$ points and constantly gain to windward. When the shipbuilder has done all in his power to permit of bracing the yards, the choice of the angle of bracing for particular yards on any point of sailing rests with the commanding officer, who must have regard to the efficiency of the sails as a whole, and may brace the yards to different angles on the various masts in order to minimize their mutual interference and obtain the best propelling effect. Experience also gives the means of deciding, in vessels of different rig and different under-water form, what disposition of the sails gives the best result under any selected set of circumstances.

The late Lieutenant Paris of the French Navy made a very large number of observations upon the behaviour of the training ship *Jean Bart* when sailing on different courses with varying sail-spreads and forces of wind.† These observations included eight points of sailing; and, on each of these points, four descriptions of sail-spread and six speeds. They extended over 138 days, and numbered about fifteen hundred. Although, from the nature of the case, it is not possible to generalize for all sailing ships from this series of observations on a particular vessel, the results recorded are of great value, and well repay the study of all interested in the performances of sailing ships. Only a few examples can be given.

The *Jean Bart*, sailing as close to the wind as was possible, with her yards braced about 32 degrees from the middle line, could keep, it is said, within $5\frac{1}{2}$ to 6 points of the true wind. Her mean speed

* See "Papers on Naval Architecture," vol. ii. ; also Fincham "On Mast-ing Ships."

† See his posthumous work, "Observations sur les vitesses relatives du Vent et du Navire." Paris: 1885.

was found to be about *four-tenths* that of the true wind under these circumstances; the apparent speed of the wind was about 20 per cent. greater than the true wind, and its line of action was inclined to the sails about 20 degrees less than the line of action of the true wind, or about 15 degrees to the sails.

When the true wind was abeam, the mean speed of the ship was six-tenths that of the true wind. The yards were braced to an angle of 45 degrees, and the apparent wind was about 11 per cent. greater in velocity than the true wind, and made an angle of about 23 degrees with the sails. This was the best point of sailing of the *Jean Bart*.

When the true wind was two points abaft the beam, the mean speed of the ship was one-half that of the true wind. The apparent wind then acted nearly on an athwartship line, and the yards made an angle of from 22 to 30 degrees with the apparent wind, according to the amount of sail carried. The apparent speed of the wind was about 12 per cent. less than the true speed.

Lieutenant Paris was careful to remark that there was an extreme variety in the relative speeds of the ship and the wind on a given point of sailing, even when no sufficient causes for the variation could be traced. As his attempts at classification were unsuccessful, he decided to take all the observations for each point of sailing, including changes in sail-spread, and as a rough-and-ready method to average the results, on the assumption that errors or variations might be considered to neutralize one another. His results, therefore, although apparently precise in their form of summarized statement, only express averages, and do not indicate limits of variation. They are superior, however, to any other published records of the kind.

One other point in these observations deserves mention, because it has an important bearing on the speeds attained by sailing ships, especially in light winds. When the *Jean Bart* came fresh out of dock with a clean bottom, the gain in speed for a given velocity of wind, as compared with the performance when the bottom was foul, ranged from 12 to 21 per cent. according to the point of sailing, and averaged nearly 17 per cent. The explanation is simple. At moderate speeds (as appears from the remarks on p. 466), frictional resistance is the greatest factor in the total resistance of sailing ships. Foulness of bottom, therefore, at once makes itself felt. In the Royal Navy it has been found, for similar reasons, that zinc-sheathed ships of equally good form and rigged in the same way are inferior in their rates of sailing to copper-sheathed ships, which have smoother bottoms after they have been a comparatively short time out of dock.

Preparation of Sail Plans for Ships.—When the naval architect undertakes the preparation of the sail plan for a new design, he

deals principally with *plain sail* or *working sail*, and usually does not include in his calculations all the sails with which a ship may be furnished. Plain sail may be defined as that which would be commonly set in a fresh breeze (Force 5 to 6), which is assumed to correspond to a pressure of about 1 lb. per square foot of canvas. The following tabular statement shows concisely what sails are generally included in the plain sail of various classes of ships; and although the sails not included are of value, especially in light winds, yet it will be obvious that those named in the table are the most important.

Style of rig.	Plain sail.
Ship . . .	Jib, fore and main courses, driver, three topsails, and three top-gallant sails.
Barque . . .	As ship, except gaff-topsail on mizen-mast.
Brig . . .	As ship, exclusive of mizen-mast.
Schooner . . .	Jib, fore stay-sail, fore-sail, and main-sail.
Cutter . . .	Jib, fore-sail, and main-sail.

Notes to Table.

In brigs, one-half the main course and the driver are sometimes taken instead of the whole of the main course.

In schooners, the fore topsail is sometimes included.

In yawls, besides the sails named for cutters, the gaff-sail on the mizen is included.

It will be understood in what follows that, except in cases specially mentioned, we are dealing only with plain sail, and not with total sail area.

In arranging the plan of sails for a new ship, the naval architect has to consider three things: (1) the determination of the total sail-spread; (2) the proper distribution of this sail in the longitudinal sense, including the adjustment of the stations for the masts; (3) the proper distribution of the sail in the vertical sense, in order that the vessel may have sufficient stiffness.

First: as to the determination of the *total area* of plain sail in new design.

Other things being equal, the propelling effect of the sails of a ship depends upon their *aggregate area*. Wind pressure and the management of ships are necessarily varying quantities. Hence for equal speeds the area of plain sail in two ships should be made proportional to their respective resistances at those speeds. For speeds such as are ordinarily attained under sail, frictional resistance furnishes by far the larger portion of the total resistance; and when the bottoms of two ships are equally rough—having the same coefficient of friction—the frictional resistances will be proportional

to the immersed or "wetted" surfaces of the bottoms. If the two ships are similar in form, but of different dimensions, the wetted surfaces will be proportional to the *two-thirds* power of their displacements; for these surfaces will be proportional to the *squares* of any leading dimension—say the length—while the displacements will be proportional to the *cubes* of the same dimensions. Put in algebraical language, if W_1 be the displacement of one ship, S_1 the wetted surface, and A_1 the area of plain sail; while W_2 , S_2 , and A_2 are the corresponding quantities for another similarly formed ship: then for equal speeds under sail we must have—

$$\frac{S_1}{S_2} = \frac{A_1}{A_2} = \left(\frac{W_1}{W_2}\right)^{\frac{2}{3}}$$

Suppose, for example, that $W_1 = 8W_2$; then—

$$\frac{A_1}{A_2} = \left(\frac{8W_2}{W_2}\right)^{\frac{2}{3}} = 8^{\frac{2}{3}} = 4; \text{ or } A_1 = 4A_2$$

Although the attainment of a definite speed under certain conditions does not form part of the design of a sailing ship, as it does in a steamship, yet it may be interesting to notice a roughly approximate method for determining the sail-spread of a new ship when it is desired to give her greater speed than that of the typical ship or ships used as examples. Let it be assumed, as may be fairly done, that the resistance of these ships varies as the square of the speeds, within the limits of speed considered. Further, let it be assumed that the effective pressure (per square foot) of the wind on the sails is the same for both ships.* Then, if V_1 and V_2 be the maximum speeds, and the other notation remains as before, we have—

$$A_1 = k(W_1)^{\frac{2}{3}} \times V_1^2$$

$$A_2 = k(W_2)^{\frac{2}{3}} \times V_2^2$$

where k is a constant, and the same for both ships. Hence

$$\frac{A_1}{A_2} = \left(\frac{V_1}{V_2}\right)^2 \times \left(\frac{W_1}{W_2}\right)^{\frac{2}{3}}$$

is an equation from which the new sail-spread (A_2) may be determined approximately; but for the reasons given above it has little practical value.

Keeping to the ordinary assumption that equality of speed is

* This latter assumption is not strictly correct, since the difference in speed must produce some difference in the apparent direction and velocity of the wind.

The character of the correction required will be understood from the remarks previously made.

aimed at in the new and old sailing ships compared, it would no doubt be preferable when arranging the sail-spread of a new ship differing considerably in form from the exemplar ship to determine the resistances by model experiments, and then to proportion the sail-areas to those resistances. On the whole, the equation on the previous page, although obtained under the limitations stated, is considered a sufficient guide in most cases, when comparing the sail-powers of ships not similar in form, provided the dissimilarity is not very great. It is usual in the Royal Navy to compare the "driving powers" of the sails in different ships by the ratio—

$$\text{Sail-spread} : (\text{displacement})^{\frac{2}{3}}.$$

But it is fully recognized that, if there is considerable difference in form, it is preferable to use the ratio—

$$\text{Sail-spread} : \text{wetted surface}.$$

It may happen that when the equation on p. 514 is used to determine the sail-spread for a new ship, it gives results which are inadmissible. For example, a ship may not have sufficient stability to carry the sail-area which the formula would assign to her; or it may be impossible to find room for the efficient working of the theoretical sail-spread. This statement is tantamount to another, which is fully borne out by experience, viz. that in ships of different types and sizes, different "driving powers" of sail have to be accepted, and the hypothetical condition of equal speeds abandoned.

Formerly it was the practice to proportion the area of plain sail to the *area of the water-line section* of ships; and this would agree with the foregoing rule so long as the condition of similarity of form was strictly fulfilled. But, when the vessels compared are dissimilar in form and proportions, it becomes preferable to express the sail-area as a multiple of the two-thirds power of the displacement, rather than as a multiple of the area of the water-line section. Very similar remarks apply to another method once commonly used, in which the area of plain sail was proportioned to the area of the *immersed midship section*; a plan which was applicable only when the vessels compared were similarly formed. Still another method of stating the sail-spread is to express it as a multiple of the displacement (in tons). A ship of 3500 tons displacement with 24,500 square feet of plain sail would be described as having 7 square feet of canvas per ton of displacement. From the explanations given above, it will be seen that, if anything like a constant ratio of sail-area to displacement were maintained, large ships would be much superior to smaller ships in driving power and speed. Hence it was the practice, in former times, to increase the ratio greatly as ships diminished in size; so that the smaller classes

might be as fast as, or faster than, the larger. This practice still holds good, in yachts and vessels designed to perform well under sail; as size is diminished the sail-spread is made proportionately greater, and the consequent risks are accepted, because it is recognized that the smallness of individual sails makes them easily handled.

A full statement of the sail-spread considered desirable in different classes of ships would occupy space far exceeding the limits at our disposal.* The treatise on "Masting Ships" published some years ago by Mr. Fincham contains detailed information on the subject that can still be studied with advantage, embracing, as it does, not merely the particulars of sailing ships of various obsolete classes, but also those of the classes of unarmoured steamships of the Royal Navy designed before the ironclad reconstruction began. In this work the area of plain sail is expressed as a multiple of the area of the water-line section, and the following figures may be interesting. For ship-rigged vessels the area of plain sail was from 3 to 4 times the water-line area; for brigs and schooners, from $3\frac{1}{2}$ to $3\frac{3}{4}$ times; and for cutters, from 3 to $3\frac{1}{2}$ times. These ratios were for sailing vessels; in their unarmoured successors, possessing both steam and sail power, the ratio was not so high, and in a great many ship-rigged vessels fell to 2 or 3. In armoured ships of the Royal Navy, with good sail-power, the corresponding ratio is in some cases a little above and in others a little below 2. In sailing ships of the mercantile marine the corresponding ratio has been found to vary from $2\frac{1}{4}$ to 3 in a large number of examples, $2\frac{1}{2}$ being a good average; but this mode of measuring the sail-spread is not commonly employed by private shipbuilders.

Taking the ratio of sail-spread to area of immersed midship section, it appears that in the obsolete classes of sailing war-ships this ratio varied from 25 to 30 in line-of-battle ships, up to 30 to 45 in frigates, and 40 to 50 in brigs and small craft. This mode of measurement is still used in the French Navy, and M. Bertin thus summarized their practice. In the obsolete sailing line-of-battle ships the ratio was from 30 to 35, in frigates 35 to 40, for smaller classes sometimes as high as 50. In unarmoured ships, with steam and sail, the French practice gave ratios of sail-spread to midship section varying from 28 in line-of-battle ships to 40 in frigates and cruisers. In French ironclads the ratio has not exceeded 20. For

* For many of the facts as to merchant ships given hereafter, the author has to thank the late Mr. John Ferguson and the late Mr. Bernard Waymouth (Secretary of Lloyd's Register). From

the "Report on Masting," made by Lloyd's surveyors, he has also obtained valuable *data*. For the facts as to yachts, he is principally indebted to the works of Mr. Dixon Kemp.

English ironclads, equipped for sailing, the ratio varied from 18 to 25; for unarmoured frigates of the older classes it was about 32, and for swift cruisers like the *Inconstant*, 26. For corvettes and sloops the corresponding ratios were 23 to 33. For sailing ships of the mercantile marine the ratio varied from 22 to 35 in a great number of ships examined, about 28 being a good average value.

The ratio of sail-spread to displacement is not commonly used for war-ships, but is frequently employed for merchant ships. It is unnecessary to repeat the remarks made above as to the limitations within which this mode of measurement can be usefully employed. In a considerable number of sailing merchantmen this ratio has been found to vary from $4\frac{1}{2}$ to 8, the largest ratio occurring in the ships of least displacement. For ships below 2000 tons displacement $6\frac{1}{2}$ is a good average value; for larger ships up to 4000 tons displacement $5\frac{1}{2}$ to 6 is a fair value. Simply as a matter of comparison, it may be stated that in the obsolete classes of sailing men-of-war the ratio of sail-spread to displacement varied from about 6 in the largest classes (4000 to 5000 tons displacement) up to 12 or 15 in frigates (of 1200 to 2000 tons displacement), and 20 to 30 in the brigs and small craft. For unarmoured ships of the Royal Navy, having steam as well as sail power, the ratio was about 5 to 7 for frigates, 5 to 6 for corvettes, and 9 to 12 for sloops. For the armoured ships it commonly varied between 3 and 4, rising to 6 in a few of the smallest vessels.

Another mode of comparing sail-spreads occasionally used in the mercantile marine is to express the ratio of the sail-spread to the under-deck tonnage. For ships of similar class (as explained in Chapter II.) this tonnage bears a fairly constant ratio to the displacement at the deep load-line. Hence the practice now being described is open to the same objections as were urged against the preceding method. From 12 to 16 are common ranges in the ratio of sail-spread to under-deck tonnage, and 13 is a good average in ships of moderate size.

Comparing these various classes by the ratio which the sail-spread bears to the two-thirds power of the displacement, the following results may be interesting. The numbers represent, for some typical ships of war, the quotient:—

SAILING—		Sail-spread ÷ (displacement) ^{$\frac{2}{3}$} .	STEAM AND SAIL—	
Line-of-battle ships . .	100 to 120		Ironclad ships	60 to 80
Frigates	} 120 to 160		Unarmoured—	
Corvettes			Frigates	} 80 to 120
Brigs			Corvettes	
			Sloops	

It will be remarked that the proportionate sail-power of the steam unarmoured frigates, etc., was, on the whole, less than that of the sailing vessels, and that the armoured ships stand still lower in the scale. But it must be noticed that some of the steamships had finer forms and proportions than the sailing ships, so that their resistances were proportionately less. Further, it is important to note that the great increase in displacement which accompanied the construction of ironclads rendered it practically impossible to give to these heavy vessels a spread of sail comparable in propelling effect to that of the sailing line-of-battle ships, even if other and more important qualities had been sacrificed. Take, for example, the 80-gun sailing line-of-battle ship *Vanguard*, with a displacement of 3760 tons and sail-spread of 28,100 square feet, the quotient sail-spread \div (displacement) ^{$\frac{2}{3}$} was not much below 120. In the best equipped ironclads of moderate size built for distant services the corresponding quotient was about 75, and in most of the heavier ironclads it was less.

In connection with the work of the committee on designs for ships of war in 1871, this matter was considered, and the *Hercules* ironclad was taken as a typical case. It was shown that if her sail power had been proportioned to the two-thirds power of her displacement (8800 tons) as in the sailing line-of-battle ship *Vanguard*, the total area of plain sail would have been increased from its actual value (about 29,000 square feet) to nearly 50,000 square feet. Having regard to the limitations in height of masts imposed by the conditions of stability, and to the number of masts which could be fitted in a ship 325 feet in length, it was obvious that such an increase in sail-area was impracticable. In fact, it was agreed that in armoured ships with single screws, the possible sail spread in most cases could not exceed that required to enable the ships to proceed under sail alone, in case of emergency, or when desired to economize fuel. Manœuvring under sail, in the manner common before the ironclad period, was admitted to be neither necessary nor possible under the new conditions. In twin-screw vessels sail was still more distinctly reduced to a mere auxiliary to steam, as the drag of the twin-screws was found to be serious when proceeding under sail alone. The general use of twin-screws since 1870, and the desire to diminish "top-hamper" in order to increase fighting efficiency, have caused the practical abandonment of sail power in all but the smallest classes of war-ships, so that the subject of sail equipment has ceased to have the importance it had formerly.

Although it is not usual to express the sail-area of merchant ships in terms of the two-thirds power of the displacement, it may be interesting to state that in a great many cases examined, the

area of plain sail has been found to vary from 70 to 110 times the two-thirds power of the displacement, and 80 to 85 times seems to be about the average. There will, of course, be great differences in sail-spread according to the intended service, and the ordinary trader will carry much less sail than clippers built primarily for fast sailing.

Yachts stand quite apart from other classes of sailing ships, and cruising yachts differ greatly from vessels built especially for racing. The latter are necessarily influenced greatly in sail equipment as well as design by the rules for measurement (or rating for competitive sailing) in force at the time when they are built. It is an interesting study to trace the influence of changes in these rules on the types and sail equipments. All that can be done here is to briefly summarize present practice. Under the Thames measurement and modifications thereof, no regard was had to sail-spread in settling the rating of yachts. The tendency, therefore, was to have large sail-areas, and to use large relative weights of ballast in order to give sufficient stiffness to the long narrow and deep type of yachts which were built under these rules. Since 1886 (see p. 76) the formula of the Yacht Racing Association takes account of sail-area, and the best authorities agree that as a consequence sail has been reduced in all classes of yachts. The sail-area used in that formula must not be confused with "plain sail" as defined above for cutters and schooners, but includes in addition to the lower sails there enumerated, the topsails, spinnaker, etc. Having regard to the great varieties of under-water forms in yachts, differences in areas of deadwoods, keels, etc., it is generally admitted that the fairest mode of proportioning sail-areas is to express them in terms of wetted surfaces. For British racing yachts four square feet of sail-area to one square foot of wetted surface is said to be a common value; for American yachts, nearly six square feet of sail to one of wetted surface is usual.

There are great differences in the proportion of sail-areas to displacements in different sizes of yachts for reasons given above, as well as in the proportion of sail-area to the two-thirds power of the displacement. In small yachts there are commonly from 100 to 150 square feet of sail per ton of displacement; in large yachts the corresponding numbers vary from 55 to 80. In small yachts the quotient of sail-area divided by the two-thirds power of the displacement ranges from 230 to 300, and in some cases goes higher; in large yachts the corresponding numbers vary from 260 to 300. Mr. Dixon Kemp states that for British yachts the cube root of the displacement in cubic feet is usually found to be *one-fifth* of the square root of the sail-area; while it is *one-sixth* in American yachts.

If displacements are expressed in tons, this rule is equivalent to saying that the quotient of sail-area, divided by the two-thirds power of the displacement, is ordinarily about 267 for British yachts, and 385 for American yachts. Average values are obviously not very safe guides in these special classes of racing yachts. The figures given are interesting, however, as indicating the enormous relative spread of sail given to yachts as compared with sailing ships of all other classes mentioned above.

Secondly: In the arrangement of sail-plans it is important to secure a proper *longitudinal distribution* of the sails, in order that neither excessive ardency nor excessive slackness may result, and that sufficient handiness or manœuvring power under sail may be secured. It has already been shown that the difficulties attending any attempt at a general solution of this problem are insuperable, and we are now concerned only with the methods adopted in practice.

The line of action of the resultant wind pressure changes its position greatly under different conditions; the naval architect therefore starts with certain assumed conditions in order to determine the "centre of effort" of the wind on the sails. All the plain sails are supposed to be braced round into the fore-and-aft position, or plane of the masts, and to be perfectly flat-surfaced. The wind is then assumed to blow perpendicularly to the sails, or broadside-on to the ship, and its resultant pressure is supposed to act perpendicularly to the sails, through the common centre of gravity of their areas. This common sense of gravity is determined by its vertical and longitudinal distance from some lines of reference, those usually chosen being the load water-line, and a line drawn perpendicular to it through the middle point of the length of the load-line, measured from the front of the stem to the back of the sternpost. Fig. 156 shows a full-rigged vessel with her sails placed as described, the centre of gravity of the area of plain sail, or "centre of effort," being marked C. A specimen calculation, illustrating the simple process by which the point C is determined, is given in the table on next page.

When the centre of effort of the sail-area has been determined relatively to the middle of the load-line, it is usual also to determine the longitudinal position of another point, commonly styled the "centre of lateral resistance." This is marked L in Fig. 156, and is simply the centre of gravity of the immersed portion of the plane of the masts—the same plane area which was referred to in an earlier part of the chapter as considerably influencing the leeway of a ship sailing on a wind. It will, of course, be understood that the point L is no more supposed to determine the true line of action of the resultant resistance than the point C is supposed to determine

CALCULATION FOR THE CENTRE OF EFFORT OF THE SAILS OF A SHIP.

Sails.	Areas.	Distances of centres of gravity from middle of load-line.		Longitudinal moment of sails.		Heights of centres of gravity above load-line.	Vertical moments of sails.
		Before.	Abaft.	Before.	Abaft.		
Jib	1,000	145	—	145,000	—	48	48,000
Fore course . . .	2,300	85	—	195,500	—	36	82,800
" topsail . . .	2,500	83	—	207,500	—	74	185,000
" top-gallant sail	1,100	82	—	90,200	—	108	118,500
Main course . . .	3,000	—	20	—	60,000	85	105,000
" topsail . . .	2,500	—	23	—	57,500	76	190,000
" top-gallant sail	1,100	—	25	—	27,500	110	121,000
Driver	1,600	—	120	—	192,000	40	64,000
Mizen topsail . .	1,300	—	160	—	130,000	66	85,800
" top-gallant sail	600	—	103	—	61,800	92	55,200
Total area of plain sail	17,000			638,200	528,800	17,000	1,055,600
				528,800			
				17,000	109,400		
Centre of effort before middle of load-line				6.43 feet.			
Centre of lateral resistance abaft ditto				6.0 "			
Centre of effort before centre of lateral resistance				12.43 feet.			
						Centre of effort above load-line	62.1 feet.

the line of action of the resultant wind pressure. But, on the other hand, experience proves that the longitudinal distance between the centre of effort C and the centre of lateral resistance L should lie within the limits of certain fractional parts of the length of the load-line.

From the drawings of a ship the position of the centre of lateral resistance may be determined by a very simple calculation; and

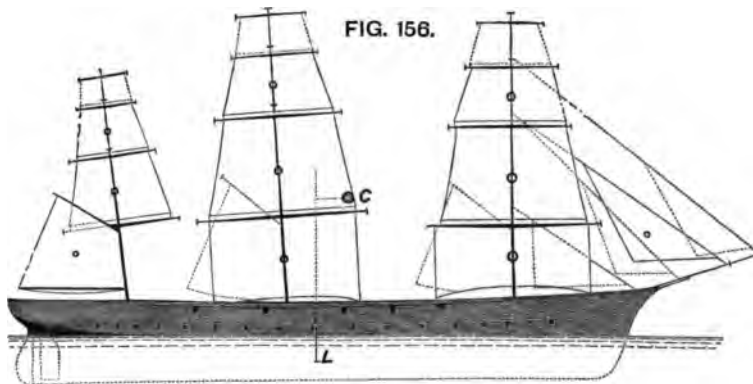

the particulars required for an approximate calculation are easily obtainable from the ship herself, being the length at the load-line, draught of water forward and aft, area of rudder, and area of aperture in stern for screw, if the vessel be so constructed.

The distance of the centre of effort before the centre of lateral

resistance varies according to the style of rig; and in determining it, regard must be had also to the under-water form of a ship. A full-bowed ship, for example, should have a greater proportionate distance between the two centres than a ship of the same extreme dimensions and draught, but with a finer entrance. In ships trimming considerably by the stern, and with a clean run, the distance between the centres should be made proportionately less. In ship-rigged vessels and barques the centre of effort is usually from one-fourteenth to one-thirtieth of the length before the centre of lateral resistance; one-twentieth being a common value. The greater distance (one-fourteenth) occurred in the old sailing ships of the Royal Navy, with full bows and clean runs; this has been almost equalled in some of the later masted ironclads, where the centre of effort has been placed one-sixteenth of the length before the centre of lateral resistance. The smaller distance occurs in screw frigates of high speed and fine form, such as the *Inconstant*; in the unarmoured screw frigates which preceded them, the distance was from one-twentieth to one-twenty-fourth of the length. In brigs, one-twentieth of the length is a fair average for the distance between the two centres. In schooners and cutters, the two centres are always very close together, their relative positions changing in different examples, and the centre of lateral resistance sometimes lying before the centre of effort. Mr. Dixon Kemp considers that for racing yachts the centre of effort of the sails should be placed about one-fiftieth of the length before the centre of lateral resistance; and for cruising yachts recommends that they should lie in the same vertical line. For yawls the centre of effort should be a little further aft than in cutters or schooners. It is to be noted, however, that in a vessel with square sails the longitudinal position of the centre of effort will vary but very slightly, however wide may be the differences between the angles to which the yards are braced. On the contrary, in a schooner or cutter the centre of gravity of the plain sail must move forward with any angle of departure from the hypothetical position in the plane of the masts.

In the designs of sailing men-of-war, it was formerly the practice to express the longitudinal position of the centre of effort in terms of its distance from the centre of buoyancy; and it was generally agreed that the centre of effort should lie further forward than the centre of buoyancy. Chapman, the famous Swedish naval architect, laid down the rule that the distance between these two centres should be between one-fiftieth and one-hundredth of the length; but considerable departures were made from this rule in practice. Cases occurred where the distance was as great as one-thirtieth of the length.

A similar practice still prevails in the designing of merchant sailing ships; and even greater variations occur in the relative positions of the two centres. Cases have occurred where the centre of effort has been as much as one-twentieth of the length before the centre of buoyancy; and others where it has been one-fiftieth of the length abaft. Such variations clearly indicate an absence of conformity to any fixed rules, other considerations—such as convenience of stowage or accommodation—largely influencing the longitudinal distribution of the sail.

Having decided upon a suitable distance between the centre of effort and centre of lateral resistance for a new design, it is next necessary to station the masts and distribute the sail in such a manner that the required position of the centre of effort may be secured, in association with sufficient manœuvring power and a proper balance of sail. In the following table the results of experience with various classes of ships are summarized, all the vessels being supposed capable of proceeding under sail alone.

The length of a ship at the load-line, from the front of the stem to the back of the sternpost, being called 100, the other lengths and distances named will be represented by the following numbers:—

Rig and class of vessel.	Distance from front of stem.			Base of sail.
	Foremast.	Mainmast.	Mizenmast.	
Ship or barque rig:—	—	—	—	125 to 160
Obsolete classes of sailing ships of war.	12 to 15	55 to 58	80 to 90	—
Unarmoured war-ships, steam and sail.	13 to 18	56 to 59	84 to 86	—
Sailing merchantmen.	20 to 22	53 to 55	80 to 88	—
Ditto (four masts)	14	38 to 40	{ 64 to 66 } Jiggermast 86 to 87	—
Brig	17 to 19	64 to 65	—	160 to 165
Schooner*	16 to 22	55 to 61	—	160 to 170
Cutter	36 to 42	—	—	170 to 190
Yawl	38	—	{ variable } abaft (sternpost)	—
Ketch	39	—	90	—

The most successful sailing ships yet built, both in war fleets and in mercantile marines, have had three masts. In some of the earlier

* These are Fincham's rules: in modern schooner-yachts no fixed rule appears to be followed, the masts being placed much closer together, in order to increase the size of mainsail.

ironclads from 380 to 400 feet in length, four and five masts were adopted, in order to increase the sail-spread while keeping the centre of effort low. Although the masts could be well spaced in these long ships, and the sails on each kept far apart, the departure from precedent did not prove successful. A few large ironclads intended to sail, as well as steam, have been "brig-rigged" on two masts, but not with much success. In merchant steamers of great length four or five masts are sometimes employed, and the *Great Eastern* had six masts; the sail power in all these cases is relatively small, and auxiliary to steam. Now that twin-screws are extensively employed in the largest passenger and cargo steamers, sail is practically abandoned in many cases. The new Cunard steamships of 600 feet in length have only two masts. Sailing ships in the mercantile marine have, in recent years, been largely increased in size; and in vessels from 260 to 375 feet in length four and five masts have been fitted for the same reasons as are given above in connection with the earlier ironclads, viz. that a large sail-spread is secured in association with a comparatively low position of the centre of effort, and a sufficiently wide spacing of the masts to secure the efficient action of all the sails. These large vessels are designed primarily for increased carrying power, and not for the purpose of making faster passages than the smaller vessels formerly built.

The "rake" given to the masts in different classes of ships requires a few words of explanation. In nearly all cases it is an inclination *aft* from the vertical line drawn through the heel of the mast; but in vessels with "lateen" rig the foremast commonly rakes forward considerably. The following are common values for the rake aft. In cutters, from $\frac{1}{12}$ to $\frac{1}{6}$ of the length; in schooners, for foremast, from $\frac{1}{10}$ to $\frac{1}{4}$, and for mainmast, from $\frac{1}{6}$ to $\frac{1}{4}$; in brigs, for foremast, from 0 to $\frac{1}{30}$, for mainmast, from $\frac{1}{18}$ to $\frac{1}{13}$; in ships, for foremast, from 0 to $\frac{1}{36}$, for main and mizen masts, from 0 to $\frac{1}{12}$. It is customary to have the greatest rake in the aftermost mast, and the least in the foremast. Graceful appearance, greater ease and efficiency in supporting the masts by shrouds and rigging, and the possibility of bracing the yards sharper when the masts are raked aft and the rigging led in the usual way, are probably the chief reasons for the common practice. The "steeve" given to the bowsprit is also in great measure a matter of appearance; but it is useful, especially in small vessels, in giving a greater height above water for working the head-sails in a seaway. In some large warships intended to act as rams, the bowsprits have been fitted to run-in when required; the steeve was very small, but the height above water was considerable.

The table also gives a length for the "base of sail," in terms of

the length of the ship, and this exercises an important influence on the manœuvring power of a vessel. In Fig. 156 it would be measured from the foremost corner (or "tack") of the jib to the aftermost corner (or "clew") of the driver; in other classes it would be measured between extreme points corresponding to those named. The base of sail is usually proportionally greater in vessels wholly dependent on sail-power than in vessels with steam and sail-power. Special circumstances may, however, limit the length of the base of sail; and one of the most notable cases in point is to be found in her Majesty's ship *Temeraire*, a *brig-rigged* vessel of over 8400 tons displacement, where the departure from ship rig was made in order to facilitate the arrangements for heavy chase guns at the bow and stern.

Experience has led to the formation of certain rules for determining the proportionate areas of the sails carried by the different masts, with various styles of rig. According to Mr. Fincham and other authorities, in ship-rigged sailing vessels of the earlier classes, if the area of the plain sail on the mainmast was called 100, that on the foremast varied from 70 to 77, and on the mizenmast from 46 to 54. In the ships of the Royal Navy, the later practice has been to make the corresponding sails on the fore and main masts alike, except the courses; and calling the sail-area on the mainmast 100, that on the foremast would commonly be from 90 to 95, that on the mizen 45 to 55, and the jib from 15 to 20, the latter agreeing fairly with the practice in sailing vessels. In barque-rigged vessels the sail-area on the mizen is often about one-third only of that on the main, the sail-area on the foremast having about the same proportion as in ships. In brigs the sail on the foremast varies from 70 to 90 per cent. of that on the main; in schooners it is often about 95 per cent.

In sailing merchantmen the distribution of sail varies considerably. The following appear to be good average values. Calling the sail-area on the mainmast 100 in ship-rigged vessels, that on the foremast varies from 90 to 95, and on the mizen from 55 to 60; the jib varies from 10 to 12. In barque-rigged vessels the corresponding numbers are: mainmast 100, foremast 90 to 95, mizen 25 to 30, jib 10 to 15. In four-masted ships the main and mizen carry about equal sail-areas; calling this 100, the jib is about 8 to 10, the foremast 85 to 95, and the jigger 55 to 60 in some good examples; in a four-masted barque the jigger has been found as little as 20 to 25.

The handiness of a ship under sail, particularly in the earlier movements of any manœuvre, is somewhat affected by the distance of the centre of gravity of the ship from the centre of effort. This

consideration was formerly treated as of great importance, but it now has little influence in the actual arrangement of sail plans. The longitudinal position of the centre of gravity for the load-draught is usually fixed by other and more important conditions; and its position changes considerably as the amount and stowage of weights on board are varied. It will suffice to say, therefore, that, when a ship is turning, her motion of *rotation* may be regarded as taking place about a vertical axis passing through the centre of gravity, which point simultaneously undergoes a motion of *translation*. Hence it follows that the turning effect of any forces will vary with the distance from the centre of gravity of their line of action. Suppose a ship to have all plain sail set, and to be balanced so that her course can be kept without using the rudder, the line of action of the resistance will lie in the same vertical plane with the resultant wind pressure, which may be supposed to pass through the centre of effort. Then, in tacking, the resistance tends to throw the head of the ship up into the wind and to assist the helm, but it tends to resist the helm in wearing. The further forward of the centre of gravity the centre of effort is placed, the greater will be the *initial* turning effect of the resistance when a manœuvre begins. But as soon as changes are made in the sails which "draw" in order to assist the manœuvre, and as soon as the action of the rudder is felt, the speed and course of the ship alter, and the initial conditions no longer hold, the line of action of the resistance changing its position from instant to instant.

Lastly: in arranging the sail-plan of a ship, it is necessary to consider their *vertical* distribution, which governs the height of the centre of effort, and the "moment of sail" tending to produce transverse inclination.

The specimen calculation on p. 521 shows the ordinary method of estimating the vertical position of the centre of effort when the plain sail is braced fore-and-aft. If the line of action of the wind is assumed to be horizontal, the steady speed of drift to leeward will supply a resistance equal and opposite to the wind pressure, and having a line of action approximately at mid-draught. This couple will incline the ship transversely until an angle of heel is reached for which the moment of stability equals the moment of the inclining couple. Let A = area of plain sail, in square feet; h = the height (in feet) of the centre of effort above the mid-draught, when the ship is upright; m = the metacentric height (GM) in feet of the ship; D = the displacement (in pounds); p = the average pressure, in pounds per square foot, which the assigned velocity of the wind would produce upon the sail-area when placed at right angles to the wind; and a = the angle of steady heel. Then, within the limits of the

angles of steady heel reached in practice, the following equations may be considered to hold:—

$$\text{Moment of sail, to heel ship} = A \times h \times p \cos^2 a;$$

$$\text{Moment of statical stability} = D \times m \times \sin a;$$

whence is obtained the following equation for the angle a :—

$$\sin^2 a + \frac{D \cdot m}{A \cdot p \cdot h} \sin a - 1 = 0.$$

Since a is usually an angle of less than 6 or 8 degrees, this equation may, without any serious error, be written—

$$\frac{D \cdot m}{A \cdot p \cdot h} \sin a = 1; \text{ or } \sin a = \frac{A \cdot p \cdot h}{D \cdot m}$$

Suppose, for example, that $p=1$, and that, in the case of Fig. 156, $D = 6,800,000$; $m=3$ feet; $A = 15,600$; and the mean draught 20 feet. Then $h = 62 + 10 = 72$ feet;

$$\sin a = \frac{15,600 \times 72}{6,800,000 \times 3} = \frac{468}{8500} = \frac{1}{18} \text{ (nearly),}$$

$$a = 3\frac{1}{4} \text{ degrees (nearly).}$$

From the remarks made on p. 501 it will be understood that, in practice, the determination of the average pressure p in this formula is not possible, in consequence of our want of exact knowledge of the laws governing wind pressures on sails. Consequently exact estimates of the angles of steady heel for ships corresponding to certain "forces" and velocities of wind, to certain assigned sail-spreads, and to certain angles of bracing for the yards, cannot be made on the basis of the preceding formula. The old assumption, resting upon no experimental data, is that for all plain sail in a ship-rigged vessel the average pressure of the wind on a surface normal to it may be taken as 1 lb. per square foot. A careful comparison of a large number of recorded angles of steady heel under all plain sail in ships whose conditions of stability and distribution of sail were known, shows that the actual angles of heel exceeded those which would be obtained on the ordinary hypothesis. Various explanations may be given of the difference thus disclosed, but it is unnecessary to enter into a discussion of them, since direct observations, by means of anemometers, of the velocities and pressures of winds producing certain inclinations in ships under sail (such as have been suggested on p. 502) would settle the matter, and, apart from such observations, it must remain open to doubt.

On the basis of experience, practical rules have been framed by which to determine approximately the lengths of the masts and

yards, and the proportionate areas of the different sails, when preparing sail-plans. For these it is impossible to find space, and they can be consulted by readers desiring information of the kind in the standard works mentioned above.

The heights of the masts and the depths of the sails were formerly proportioned to the extreme breadths of ships. Hence it became the practice to express the height of the centre of effort above the load-line in terms of the breadth. For ship-rigged vessels and barques, the ratio of this height to the breadth usually lies between $1\frac{1}{2}$ and 2; for brigs and schooners, between $1\frac{1}{2}$ and $1\frac{3}{4}$; and for the other rigs mentioned in the table on p. 523 it has nearly the same value. These approximate estimates are not to be put in place of exact calculations for the position of the centre of effort, but they are useful nevertheless. In order that the moment of sail may be estimated, the half-draught must be added to the height of the centre of effort above the load-line.

If there be no similar vessels to compare with a new design, the problem of the vertical distribution of the sail takes the form of a determination of the height h of the centre of effort above the centre of lateral resistance. In that case the whole of the quantities in the formula given above, except the height h , may be supposed known, the maximum angle of steady heel a being assigned for a pressure of 1 lb. per square foot of canvas. Hence—

$$h = \frac{D \cdot m}{A} \cdot \sin a,$$

very nearly, when a does not exceed the usual limits.

Looking back to the formula for the angle of steady heel, it will be seen that, if the ratio of $D \cdot m$ to $A \cdot h$ be the same for any two vessels, an equal force of wind p per square foot of area of sail will produce equal angles of heel in both ships. Hence it has become the practice in the Royal Navy to use this ratio as a measure of the "power of a ship to carry sail." The smaller the ratio, the less is the stiffness of the ship under canvas; the greater the ratio, the stiffer is the ship. Very considerable variations occur in this ratio in different classes. In the *Inconstant*, a vessel designed for high speed under steam as well as for sailing, the number expressing the power to carry sail was as low as 15; in the converted ironclads of the *Prince Consort* class, with metacentric heights twice as great as that of the *Inconstant*, and with a much smaller proportionate spread of canvas, the corresponding number was 51. In some of the earlier ironclads, such as the *Warrior* and *Minotaur* classes, the sail-carrying power was represented by 30 to 35; in later ironclads it was represented by 17 to 25. In the various classes of unarmoured ships very

different values occur: from 20 to 25 probably represented the sail-carrying power of the screw frigates of the older type, from 15 to 20 that of the corvettes, and from 10 to 15 that of the smaller classes. Exact information is wanting as to the metacentric heights of the older classes of sailing ships of the Royal Navy, so that no exact estimates can be made of their sail-carrying powers. It appears probable that in the smaller classes the numbers varied between 10 and 15; for the frigates, from 15 to 20; for the line-of-battle ships, from 20 to 30.

The diminution of the metacentric heights in recent years, in order to secure longer periods of oscillation, which favour greater steadiness, has led to a decreased stiffness as compared with preceding types; this latter feature being indicated by the smaller numbers of the sail-carrying power. It was important, when ships had to fight under sail, that the angle of heel should not be excessive, and 5 or 6 degrees was the limit named by writers on the subject; in steamships there is no equally powerful reason for securing equal stiffness, steadiness being the chief desideratum, and angles of heel under plain sail of 8 or 10 degrees sometimes occur.

Respecting the actual sail-carrying powers of merchant ships, there is no recorded information, and on different voyages, with varying character and stowage of cargoes, there must be great variations in the metacentric height, involving considerable changes in the sail-carrying power. Assuming that the ships are so stowed that they have metacentric heights of 3 to $3\frac{1}{2}$ feet, the sail-carrying powers in a great number of cases we have investigated lie between 14 and 18. Mr. W. John gave 12 to 20 as corresponding values with $3\frac{1}{2}$ feet metacentric height. It may be desirable again to state that sailing merchantmen have forms and proportions such that, if they are stowed so as to secure the amount of stiffness assumed, they must have a large range of stability. But they are liable to be much less favourably situated, both as regards stiffness and range of stability, if improperly stowed.

The spread of sail carried by yachts has been shown to be enormous in proportion to their displacement, and, their metacentric heights being moderate, their sail-carrying powers are small. In some very successful English yachts the sail-carrying power has been found to lie between 4 and 8. For cruising vessels it is usually greater than in racing yachts. In the *Sunbeam*, with auxiliary steam-power, it is 8.4. In match sailing, steady angles of heel of 20 to 30 degrees are said to be not uncommon; but there is little risk of such vessels being capsized, as the ballast brings the centre of gravity very low, and they have extremely great range of stability (see curves on Fig. 63, p. 138).

The Dimensions and Proportions of Modern Sailing Ships.—Allusion has been made above to the remarkable increase in the sizes of sailing ships that has taken place in recent years, and equally notable changes have been made in their forms and proportions. The construction of sailing ships has naturally been influenced by improvements in steamships. Greater lengths, larger proportions of length to breadth, and finer forms have been adopted in sailing ships, with marked advantage in their working. Formerly it was assumed that the length of a sailing ship should not exceed four times the beam; in many vessels having high reputations the length was not much more than three times the beam. Sailing ships of war were given these moderate proportions, no doubt, because extreme handiness was desired, as well as considerable stability, so that the angles of heel should not be great, and that the guns on the lee side could be fought. These vessels necessarily had to be loftier than merchantmen, to carry considerable weights of armament on the decks instead of cargo in the holds, and generally to fulfil conditions which were essentially different from those in the mercantile marine. Consequently there was far less latitude in the choice of forms and proportions. As steam-power was introduced and sail-power subordinated, great changes were made; primarily to improve steaming performance, but with the result in many cases of giving increased speed under sail. As an example, reference may be made to H.M.S. *Inconstant*, which has made runs at speeds of from $13\frac{1}{2}$ to $14\frac{1}{2}$ knots per hour under sail alone.

The introduction of the so-called "clipper" type of fast-sailing merchantmen must be credited to the United States, although its fullest development is due to British shipbuilders.* Vessels of this type commonly have lengths from five to six times the beam, and in some cases the lengths have exceeded seven to seven and one half beams. Diminished resistance has been obtained by increased length and greater fineness of form, and the performances under sail have been remarkable on voyages of great length, even in these days of rapid steam navigation. One or two examples may be given.

The *Thermopylæ* made the passage from London to Melbourne in 60 days in 1868. On one occasion she ran 330 knots in 24 hours, with the wind strong abeam. The following tabular statement

* For details on this subject see Lindsay's "History of Merchant Shipping," and very interesting articles on "Clipper Ships" in *Naval Science* for 1873, and the *English Illustrated Maga-*

zine for October, 1891. The late Mr. Waymouth, who designed the *Thermopylæ* and other vessels, also supplied much information to the author.

enables a comparison to be made between this famous clipper and the *Pique*, which was a sailing frigate of good reputation in the Royal Navy:—

Particulars.	<i>Thermopylæ.</i>	<i>Pique.</i>
Length	210 ft.	162 ft.
Breadth	36 ft.	48½ ft.
Displacement	1,970 tons	1,912 tons
Area of plain sail	17,520 sq. ft.	19,086 sq. ft.
Area of plain sail ÷ (displacement) ³ .	110	124

The sail-spread of the *Thermopylæ* was, therefore, less proportionally than that of the *Pique*; but her greater length and fineness of form diminished her resistance, and gave to the *Thermopylæ* greater speed in making passages than the sailing frigate possessed.

The *Sir Lancelot*, built by Messrs. Steele of Greenock, made the passage from China to England in 1869 in eighty-nine days, against the prevailing monsoon, covering about 14,000 miles in that time. During this voyage she ran over 305 knots in twenty-four hours; and during one week with fresh beam winds her daily run averaged nearly 260 knots. This vessel was not quite 200 feet long, about 33½ feet broad, of 886 tons register, and had an enormous sail-spread.

Another clipper, the *Melbourne*, designed by the late Mr. Waymouth, made a remarkable passage from England to Melbourne in 1876. It occupied 74 days, the conditions being unfavourable during part of the time. From the Cape fair winds were obtained, and 300 miles a day were averaged for seventeen consecutive days. In this period the three longest daily runs were 374, 365, and 352 miles. The *Melbourne* had a displacement of about 3500 tons, an area of plain sail of about 21,000 square feet, and the ratio of sail-spread to the two-thirds power of the displacement was about 90 to 1.

These fast-sailing ships were built for special services, such as the China tea trade, where speed was of primary importance. In later years there have not been the same inducements for shipowners to imitate their predecessors, and sailing ships have been designed chiefly with a view to carrying large cargoes on very long voyages. There was a great revival in the building of sailing ships during the period 1889–92. In 1889 about 122,000 tons (gross tonnage) of sailing ships were built in the United Kingdom, rather over 9 per cent. of the total mercantile tonnage built. In 1890 the tonnage of sailing ships approached 142,000 tons, or about 11 per cent. of the total production. In 1891 the corresponding figures were nearly 230,000 tons, and over 18 per cent.; and in 1892, 275,000 tons, and

over 22 per cent. This revival was associated with the construction of very large sailing ships, of which the dead-weight carrying capacity is about 6000 tons, and the register tonnage from 3300 to 3800 tons, the lengths varying from 330 to 375 feet. These vessels are not rigged so loftily as the much smaller clipper ships above described, nor do they carry so much canvas in proportion to their size, although they have four or five masts. Steam and mechanical power are used to supplement manual labour in working the sails, for pumping, and for other purposes. Water ballast is also fitted in many cases.

The two largest sailing ships yet built in this country are the *France* and *Maria Rickmer*, both for foreign owners. The former, built by Messrs. Henderson in 1890, is 360 feet long, nearly 50 feet in beam, and has a carrying capacity of 6150 tons. The latter, built by Messrs. Russell in 1891, is 375 feet long, 48 feet beam, and has a carrying capacity of about 5700 tons. Both vessels have cellular double bottoms fitted for water ballast. The *Maria Rickmer* was notable also because she had auxiliary steam-power in the form of triple expansion engines of about 650 H.P., which were capable of driving her, when fully laden, at a speed of 6 to 7 knots per hour. This adoption of auxiliary steam-power was a return to a former practice, and was primarily intended to be made use of in the region of calms or when contrary winds are experienced. A "feathering" screw was fitted, so as to reduce its drag when the vessel is under sail, as it was intended she should be ordinarily. She was lost at sea under unknown circumstances.

Propulsion under Steam and Sail.—When ships possess fairly good sail-power as well as good steam-power, it is often found advantageous to use both means of propulsion. This is especially true in many classes of war-ships, and considerable economies of coal may be effected by the judicious use of sails as auxiliary to steam when making passages. Lieutenant Paris, in his observations on board the *Jean Bart*, endeavoured to appraise the gain in speed obtained by using both steam and sails, as compared with the speed realized with the same development of horse-power acting alone. His general conclusions were, that there is always a notable increase in speed; that the gain is irregular according to circumstances, but usually greatest when sailing close-hauled. He suggested that the increase in speed might be supposed to be proportional to the apparent wind, and taken roughly, for the *Jean Bart*, at one quarter of a knot for each metre of velocity of the apparent wind.

Professor Rankine dealt with this problem theoretically. He pointed out that the efficiency of the propeller was likely to be increased by the propulsive effect of the wind balancing a part of

the resistance of the water to the motion of the vessel. But neglecting any such increase, he proposed the following approximate rule, which would be on the safe side. Suppose the respective speeds of the ship to be known under steam alone for the given development of power, and under sail alone for the known sail-spread and known force and direction of the wind; then the cube of the speed under sail and steam will be nearly equal to the sum of the cubes of the speed under steam alone and under canvas alone.

Lieutenant Paris gave one case for the *Jean Bart* which enables Rankine's rule to be roughly tested. On a certain course and with a certain spread of sail the ship could have made $5\frac{1}{2}$ to 6 knots under sail alone, while the engine could have driven her 5.8 knots in a calm. The actual speed with steam and sail was logged at 8 to $8\frac{1}{2}$ knots. By Rankine's rule it would have been about $7\frac{1}{4}$ knots. No doubt, in practice many circumstances influence the actual results obtained, besides those which any theory can embrace. This is particularly true of the state of the sea, and the course of the ship in relation to the waves. But that the use of sails as an auxiliary to steam-power on the whole conduces to economy, is placed beyond doubt by universal experience. The steadying effect of the sail in many cases affects the results obtained.

Proportions of Yachts.—The proportions and forms of sailing yachts are necessarily influenced by the tonnage rule under which they are intended to compete. In most cases the proportions of length to beam have been between 4 to 1 and 6 to 1. Under the operation of "Thames Measurement," or similar rules (see p. 75), a severe penalty was put upon beam as compared with that on length, and no account was taken of depth. Consequently, up to 1886 there was a tendency to make British yachts relatively narrow and deep, giving them large weights of ballast. Subsequent changes in the rules for rating have tended to encourage the building of yachts of greater relative beam for racing purposes than were built under the old rules. For cruising purposes the best authorities favour a proportion of length to beam varying from 4 to 1 up to $4\frac{3}{4}$ to 1. It does not appear that any of these British tonnage rules for yachts have failed to produce handy, seaworthy, and fast vessels. Some of them have attained very remarkable speeds in proportion to their lengths and sizes, cases being on record where they have reached 13 to 14 knots per hour, while the American yacht *Sappho* is said to have made 16 knots per hour for several consecutive hours when crossing the Atlantic.

CHAPTER XIII.

STEAM PROPULSION—MEASURES OF HORSE-POWER, AND PROPULSIVE COEFFICIENTS.

THE problems incidental to steamship design are many and difficult. They admit of no general solution, because the conditions to be fulfilled vary greatly in different classes of ships. Speaking broadly, in any particular design it may be assumed that it is desired to attain a certain speed, with a specified load, and to associate with those conditions the power of traversing certain distances without taking more coal on board. There may be endless variations in the assignment of speed, load, and steaming distance. Frequently the circumstances of the intended service impose limitations on the draught of water, and sometimes these circumstances limit other dimensions. The materials and system of construction also influence the design. In the case of war-ships, the offensive and defensive powers exercise great influence on dimensions and form. Still, it is true generally that, whatever other conditions may have to be fulfilled, the designer of a steamship has to approximate to the engine-power and coal supply which must be provided, when determining the dimensions and form most suitable to the particular case.

In much of this work the naval architect and marine engineer have a joint interest, although each has his independent responsibility. Upon the latter devolves the actual design and construction of the propelling apparatus. His skill is displayed in providing machinery and boilers which shall be compact, durable, strong, and efficient, economical in consumption of fuel, and as light as they can be made in proportion to the power developed. The requirements of the engineer also necessarily exercise considerable influence on the internal arrangements, especially in vessels of high speed. In the appropriation of suitable spaces for the machinery and boilers, the efficient ventilation of those spaces, the arrangements for carrying and working the coal, the construction of engine, boiler, and shaft-bearers, and many other details of the hull-structure, the engineer must be consulted, and his wishes met as far as possible. When the

power necessary for the intended speed has been determined approximately by the naval architect, and the engineer has made a sketch-design for the propelling machinery, the choice of the most suitable propeller for the new vessel is an important matter, in which both are interested, and which must be made by mutual agreement. Apart from such joint action, the best utilization of the power developed in the propulsion of the ship cannot be secured. The engineer supplies to the naval architect data regarding the proportion of weight to power in the propelling apparatus, and the probable rate of coal consumption. The naval architect has to embody these particulars as part of a design which shall fulfil specified conditions of speed, coal endurance, and carrying capacity, while provision is made for structural strength, stability, and seaworthiness. In the preliminary stages the processes are necessarily tentative and subject to correction. The various features of the design are to a large extent inter-dependent. At the outset the dimensions, form, and displacement are undetermined. Yet upon them depend the power which the engines must develop to give the desired speed, the weight of the hull, and the weight of certain parts of the equipment. In the finished ship the sum of the weights of hull-structure, propelling apparatus, equipment, coals, and load must equal the displacement to the specified load-line. Apart from experience, a problem involving so many unknown yet related quantities could scarcely be solved. On the basis of experience, recorded data, and model experiments it is dealt with readily. Approximate dimensions and forms are first assumed. The weight of hull is then approximated to by methods explained in Chapter X., for the system of construction which will be adopted, and the type of ship. An estimate for the probable engine-power is made, either on data obtained from the steam trials of previous ships, or from model experiments. The weight of engines and boilers is then ascertained for the horsepower, and the rate of coal consumption per hour calculated on the same basis, while the total weight of coal for the intended steaming distance at the desired speed is readily deduced. Adding together these first approximations to the weights of hull, equipment, machinery, and coal, and to the total adding the load stipulated to be carried, a grand total is reached which should equal the displacement provisionally assumed. If the sum-total is in excess or defect of the provisional displacement, corrections must be made on the dimensions originally assumed, with a view to obtaining a balance. For these corrected dimensions a fresh series of approximations is made to the weights of hull, equipment, machinery, and coal. A balance between the grand total of weights and the displacement corresponding to the form and dimensions is ultimately obtained. When no large

departure is made from past experience or precedent, this preliminary work is rapidly performed. Under other circumstances, the selection of the most suitable dimensions and form may involve the consideration of many alternatives.

From the explanations given in previous pages it will be obvious that the naval architect has many other qualities to consider, in working out a new design, besides economical propulsion. He has to secure sufficient stability for the varying conditions of lading, good behaviour in a seaway, handiness, and ample structural strength. It may happen that the adoption of great length and fineness of form, while it enabled the specified speed to be obtained with a less expenditure of power, would involve an increased weight and cost of hull, more than counterbalancing savings on machinery and coal. Or the form which would be preferred for propulsion may not give sufficient stability for the variations in lading occurring on service. In short, the designer must consider the question in all its aspects, and endeavour to fulfil the conditions laid down for a new design in that manner which, on the whole, will give the best results, taking into account first cost and subsequent working.

It is proposed in this and subsequent chapters to treat of steam-propulsion chiefly as it affects the work of the naval architect. Detailed descriptions of the remarkable progress which has been made in marine engineering during the latter half of the nineteenth century would be out of place. References must be made, however, to certain stages in that progress, because they have exercised such marked influence on steamship design. Even when thus restricted, the field of inquiry is very large, and deserves most careful study. It includes the consideration of all the circumstances which must be taken into account by the naval architect in designing a steamship, and cannot be dealt with adequately without recourse to mathematical investigations which cannot be introduced into this work. An endeavour will be made, however, to indicate, in a form which may be generally understood, the principal results of such investigations, and to illustrate the principles by which the development of steam propulsion has been guided.

MEASURES OF HORSE-POWER.

Effective Horse-Power.—When a ship is towed at a uniform speed by some external force which does not interfere with the free flow of water past her hull, the strain on the tow-rope measures the resistance to her motion. Suppose this resistance to be R pounds, and the speed to be S feet per second. The product of the resistance into

the distance moved through in a second, measures the "mechanical work" done by the towing force. In symbols—

$$\text{Work done (per second)} = R \cdot S \text{ (units of work).}$$

A "horse-power" represents 550 units of work per second. Consequently—

$$\text{Horse-power (corresponding to work done)} = \frac{R \cdot S}{550}$$

This is termed the "effective horse-power," because it measures the "useful work" performed by the engines when the ship is propelled at the speed S .

As an example, take the *Greyhound*, for which the towing experiments are described on p. 476. At the speed of 16.95 feet per second, the resistance was 10,770 lbs. The corresponding effective horse-power is given by the expression—

$$\text{E.H.P.} = \frac{10770 \times 16.95}{550} = 332 \text{ H.P.}$$

When a ship is propelled by her own machinery, she is very differently circumstanced from her condition when towed. For a given uniform speed, it must be true that the thrust or reaction of the propeller will equal the resistance of the ship; only that resistance will be greater than the tow-rope strain for the same speed, because the action of the propeller modifies the stream-line system which surrounds the ship when towed. The propeller, besides driving the ship forward, sustains frictional and other resistances in its passage through the water, while in many cases it produces motions and consequent reactions of the water acted upon in directions not effective for propulsion. That is to say, there is a "waste" of work in the power delivered by the engines to the propeller, in consequence of these circumstances attending its action. Further, as between the power exerted by the engines and that delivered to the propeller, there is a sensible waste, because of the frictional and other resistances in the mechanism. Hence, in order to estimate efficiency of propulsion, it is necessary to supplement "effective horse-power" by "indicated horse-power," which measures the work done in the cylinders of the engine as the pistons move to and fro. Hereafter it will be shown how the separate efficiencies of engines (or mechanism) and propellers are estimated, and to what extent tow-rope resistances are augmented by the action of propellers.

Indicated Horse-Power.—This measure of the power exerted in the cylinders of an engine derives its name from the useful little instrument known as the "indicator." By its use diagrams are

drawn showing the variation of steam-pressure in the cylinders at different portions of the stroke of the pistons, and the mean pressure for the whole stroke is ascertained.

Let p = this mean pressure in pounds per square inch.
 A = the total area of the pistons in square inches.
 l = the length of "stroke" of pistons.
 n = the number of revolutions per minute.

Then—

$2n \cdot l$ = speed of piston (feet per minute)
 $p \cdot A$ = total mean pressure on pistons (in pounds)
 $p \cdot A \times 2nl$ = units of work done per minute.
 $\frac{p \cdot A \times 2nl}{33000}$ = indicated horse-power.

Indicated horse-power, therefore, depends upon (1) the mean steam pressure (p); (2) the "cylinder capacity" ($A \cdot l$); and (3) the number of revolutions per minute. Sometimes it is said to depend upon mean pressure, piston area, and piston speed; which is only a slight variation of the other expression. This measure of power, of course, is not a complete representation of the efficiency of the propelling apparatus, nor does it take account of the efficiency of the boilers. It is, however, the method commonly employed in statements of the horse-power developed in ships moving at various speeds.

For war-ships the tabulated powers of the engines are the average indicated horse-powers obtained, or specified to be obtained, on actual trials extending over a certain number of hours' continuous steaming, and carried out in accordance with certain fixed conditions. When "forced draught" is used, it is customary, in official returns for ships of the Royal Navy, to give the powers indicated under both "forced" and "natural" draught.

In the Royal Navy, new ships fitted with ordinary boilers are tried by steaming for eight hours continuously under natural draught, and for four hours under "forced" draught. For ships fitted with the locomotive type of boiler, the periods of continuous steaming are 3 hours under forced draught, and 8 hours under natural draught. In all cases where forced draught is employed, the limits of air-pressure in the stoke-holds are defined. These trials are made with engines and boilers in perfect order, with good coal and well-trained stokers. It is recognized that the results obtained do not represent the engine-power which could be developed over long periods of continuous steaming at sea under ordinary conditions of service. For her Majesty's ships it is assumed that, under the latter conditions, the power which should be developed when steaming "with

all despatch" for long periods should be at least 60 per cent. of the power obtained with natural draught on the eight hours' trial. In very many cases this minimum is exceeded, and in some cases considerably exceeded, the actual development of power having approximated to the specified natural-draught power over the whole period that the coal lasted.*

The present practice in the French Navy is very similar to that above described. A French *cheval vapeur* is 32,549 foot-pounds per minute instead of 33,000 foot-pounds for the English horse-power; the proportion is as 9863 to 10,000. French practice tabulates both the *maximum* power indicated on a four hours' trial (*essai a outrance*), and the *normal* power indicated during a continuous trial of twenty-four hours. In ships not fitted with forced draught, the normal power appears to be about 70 per cent. of the maximum; in ships fitted with forced draught, it falls as low as 40 per cent. of the maximum.

In other navies the conditions laid down for the trials made to determine the tabulated horse-powers differ in regard to duration of the trials, the extent of "forced" draught permitted, and other particulars. It is important, therefore, in making comparisons between the tabulated powers of war-ships in different navies to clearly ascertain under what conditions these powers have been indicated, and what proportion they bear to the powers likely to be realized over long periods of continuous steaming.

Nominal Horse-Power.—Until 1872, in all official returns the engine-power of her Majesty's ships was given in "nominal" horse-power. The matter is now one of historical interest chiefly, but, as a similar practice still obtains in the mercantile marine, it may be useful to explain the rules formerly employed. A fictitious mean pressure of 7 lbs. per square inch was assumed. In screw-steamers the *intended* piston speed (feet per minute) was taken as the true speed. Then—

$$\text{Nominal horse-power} = \frac{7 \times \text{area of pistons} \times \text{piston speed}}{33000}$$

In paddle-steamers—

$$\text{Assumed piston speed} = 129.7 \times (\text{length of stroke})^{\frac{1}{3.138}}$$

$$\text{Nominal horse-power} = \frac{7 \times \text{area of pistons} \times \text{assumed piston speed}}{33000}$$

The actual piston speeds were often much in excess of the speeds

* For details see a paper by the author in the *Transactions of the Institution of Naval Architects* for 1890.

assumed in the calculations, and the true mean pressures were much above the 7 lbs., but followed no constant law. Consequently there were very different proportions between the nominal and indicated horse-powers in different ships, and the former mode of measurement, being of no practical service, was abandoned.

In the British mercantile marine there is no legal enactment for measuring engine-power corresponding to that for the measurement of tonnage described in Chapter II. Shipbuilders and marine engineers employ indicated horse-powers for their own purposes in designing steamships and their propelling machinery. The powers developed on trial are frequently stated in published descriptions of ships. In the official registers of ships, however, only "nominal" horse-powers appear.

Formerly the rule established by the practice of Messrs. Boulton and Watt was generally employed; it was very similar to the old Admiralty rule for paddle-steamers, the same effective pressure of 7 lbs. per square inch of piston area being assumed; but the

$$\text{Assumed speed of piston} = 128 \sqrt{\text{length of stroke.}}$$

This rule was sometimes stated as follows: Let D^2 = sum of squares of diameters of cylinders (in inches); then—

$$\text{Nominal horse-power} = \frac{1}{47} \times D^2 \times \sqrt{\text{length of stroke.}}$$

At present the rule most commonly employed takes the form—

$$\text{Nominal horse-power} = \frac{1}{37} \times D^2.$$

It is sometimes expressed by the equation—

$$1 \text{ nominal horse-power} = 30 \text{ "circular inches" of piston area.}$$

This rule would correspond with that of Messrs. Boulton and Watt, if the piston speeds were assumed to be 200 feet per minute.

Various proposals have been made with a view to improving the commercial method of measuring horse-power, but none of them has found general favour. In 1872, the council of the Institution of Naval Architects, having been consulted on the subject by the Board of Trade, replied as follows: "The term 'nominal horse-power,' as at present ordinarily used for commercial purposes, conveys no definite meaning." . . . "The majority of the committee were of opinion that no formula depending upon the dimensions of any parts of the engines, boilers, or furnaces could be relied upon as giving a satisfactory measure of the power of an engine; and that even if the varieties of engines and boilers now in use could be comprised under one general expression for the power, the progress of invention would soon vitiate any such expression or formula." The committee could not agree to any alternative

mode of measuring engine-power, but the plan which met with least objection was to take either the indicated power on a trial trip as the nominal power, or some submultiple, such as *one-fourth* of the indicated power. The latter method, at that date and for some years afterwards, was used in the French Navy, the nominal horse-power being about one-fourth of that indicated on the contractor's trial. As explained above, the French now use indicated horse-power, and have abolished the "nominal."

The Council of the North-east Coast Institution of Engineers and Shipbuilders made a careful inquiry into this subject in 1888, adopting the basis of indicated horse-power, but endeavouring to formulate "normal" conditions under which all engines should be supposed to work when indicating the powers assigned to them. They proposed the following rule for "normal indicated horse-power" for surface condensing marine screw engines, working at any boiler pressure between 50 lbs. and 250 lbs. per square inch, under the specified conditions:—

$$\text{Normal indicated horse-power} = \frac{(D^2 \sqrt[3]{S} + 3H) \sqrt[3]{P}}{100}$$

In this expression

D = diameter of the low-pressure cylinder in inches, if there is only one such cylinder.

D² = sum of squares of diameters of the low-pressure cylinders, if there be more than one.

S = stroke of piston (in inches).

P = working boiler pressure in pounds per square inch above the atmosphere.

H = heating surface of the boilers in square feet.

It was urged that this rule would be practically useful to both shipowners and engineers; and that it took account of the efficiency of the boilers, as well as of those features in the engines—piston area, steam pressure, stroke, and piston speed—which govern the indicated horse-power. No general adoption of the rule has followed its publication.*

The rules issued by Lloyd's Register of Shipping contain a formula for the nominal power of triple expansion engines which may be quoted, although it is used only for special purposes. Taking the same symbols as above for stroke and heating surface, and calling D the diameter of the low-pressure cylinder in inches—

$$\text{Nominal horse-power} = \frac{1}{2} \left(\frac{D^2 \times \sqrt[3]{S}}{100} + \frac{H}{15} \right)$$

* See vols. iv. and vi. of the *Transactions* of the Institution.

It has been pointed out that this rule and that last described can be brought into practical agreement by the following further assumptions. The working pressure P in the North-east Coast rule to be taken at 150 lbs. per square inch, the square root of the stroke to be substituted for the cube root, and the stroke assumed to be 72 inches. The result obtained by these changes to be divided by 5 for nominal horse-power.

PROPULSIVE COEFFICIENTS FOR STEAMSHIPS.

Assuming that the "effective" and "indicated" horse-powers have been determined for an assigned speed in a particular ship, the ratio which the former power bears to the latter is usually termed the "propulsive coefficient," and often expressed in the form of a percentage. For example, if the effective horse-power were 5000, and the indicated horse-power 10,000, the propulsive coefficient would be called 50. Comparatively few full-scale experiments have been made on ships or boats from which the propulsive coefficients could be determined. The most important were those made on H.M.S. *Greyhound*, and described at p. 480. She was a single-screw ship built of wood, and the propulsive coefficient was about 42 for full speed. Mr. Isherwood made experiments on a single-screw steam launch, 54 feet in length.* His results give for the speed of 7 knots a propulsive coefficient of 67, which is an unusually high value. Mr. Yarrow experimented on a first class torpedo-boat 100 feet in length, and obtained a propulsive coefficient of 60 at a speed of 15 knots.

By the comparison of model experiments with the results of steam trials, propulsive coefficients have been determined for many types of ships. Absolute exactitude cannot be attributed to estimates of effective horse-power based on model experiments. The correction for frictional resistance when passing from the model to a full-sized ship is open to some doubt. It appears certain, however, that a fair approach to accuracy is obtained, and where full-scale experiments have been made this has been demonstrated. The case of the *Greyhound* has been discussed. As another example, it may be stated that the towing experiments made by Mr. Yarrow with a torpedo-boat agreed within 3 per cent. with the results of experiments with a model of the boat made in the Admiralty establishment.

Assuming that estimates for effective horse-power deduced from model experiments may be trusted, the following are values of pro-

* See Report of the Secretary of the United States Navy for 1874. For Mr. Yarrow's experiments see the *Transactions* of the Institution of Naval Archi-

tects for 1883. Full details of the *Greyhound* experiments appear in the same *Transactions* for 1874.

pulsive coefficients.* For single-screw ships with thick wood stern-posts and rudder-posts, about 40; with iron or steel stern-posts of less thickness, and fine forms of stern, from 50 to 55, rising in special cases to 60. For twin-screw ships of full form, fitted with horizontal engines and with propellers of moderate efficiency, from 40 to 45. For twin-screw ships of fine form, fitted with vertical engines, 50 to 55, and sometimes 60. For torpedo-boats and torpedo gunboats, with very quick-running engines, coefficients varying from 55 to 65 have been obtained. In these vessels the accurate measurement of the indicated horse-power is not an easy matter. At the present time, in dealing with estimates of indicated horse-power for ships of good form, on the basis of model experiments, the propulsive coefficient 50 may fairly be taken. With fuller forms a lower value would be used, and in vessels of exceptional fineness and high speed a somewhat higher value. The designer has to exercise his judgment in selecting the coefficient appropriate to each type.

In Admiralty practice there is no necessity to determine propulsive coefficients for paddle-steamers. Experiments of this nature have been made, however, by the late Dr. Tideman and by one private firm, and have furnished valuable guidance in new designs subsequently undertaken with very high speeds.

Efficiency of the Mechanism.—It may, at first sight, seem surprising that in a well-designed screw-steamer the indicated horse-power should be *twice* the effective horse-power. An examination into the causes of this waste work is therefore desirable. First, the *efficiency of the mechanism* must be noted, that efficiency being expressed by the ratio which the power delivered to the propeller or propellers bears to the indicated horse-power.

Power has to be expended in overcoming frictional and other resistances in the moving parts of the propelling machinery and the shafting. A further deduction from the indicated horse-power is necessary to provide for driving the air-pumps, etc., worked off the main engines. In a few cases the efficiency of the mechanism has been determined by direct experiments. Most of these trials have been made on small vessels, and few trials have been conducted on marine engines of considerable power. Attempts have been made also to estimate frictional resistances from the analysis of results obtained on progressive steam trials. All these steps have added to available information, particularly in regard to the engines of screw-steamers. On the other hand, the efficiency of the

* See papers by the late Mr. Froude R. E. Froude in the same *Transactions* in the *Transactions* of the Institution of Naval Architects for 1876, and by Mr. for 1886.

mechanism varies with the type of engine, the valves and valve-gear, the arrangements for working the pumps, and other circumstances. Authorities differ, therefore, in their estimates for the percentage of the indicated horse-power delivered to the propellers in screw-steamers. For the experimental steam-launch above mentioned, Mr. Isherwood placed it as high as 90 per cent., the work done on auxiliary appliances being very small. For a second-class torpedo-boat, Mr. Thornycroft made experiments showing only 77 per cent. Mr. Hall-Brown, after experimenting on triple-expansion engines of 900 H.P. and of 300 H.P. respectively, considered 85 per cent. a fair value. Mr. Blechynden, on the basis of similar experiments, arrived at the same result. For a well-adjusted modern marine engine in a screw-steamer, probably 80 to 85 per cent. of the indicated horse-power may be considered to be delivered to the propeller. The late Mr. Froude, by inference from *data* drawn principally from land-engines, fixed the percentage as rather under 70, but this was too low an estimate.*

Frictional resistances account for most of this waste work. They may be arranged under two headings: (1) "Constant" or "dead-load" friction, approximately constant at all speeds, due to the dead weight of moving parts, tightness of piston-packings, friction of shaft bearings, etc.; (2) friction due to the working load, varying with the thrust of the propeller and the speed of engines and ship. An interesting series of trials was made on H.M.S. *Iris* in 1878. The engines, which were of the horizontal compound type, driving twin-screws, were run at high speeds, disconnected from the screw shafting. At 90 revolutions, 400 H.P. was absorbed in overcoming the friction of the engines alone, and 170 H.P. in overcoming the friction of the screw shafting. The sum, 570 H.P., representing the power required to overcome the dead-load friction, was about 8 per cent. of the total indicated horse-power when the engines and screws were running at the same number of revolutions. Other experiments have given different values for the dead-load friction, ranging from 5 to 9 per cent. of the full indicated horse-power. For large ships 8 per cent. appears a fair value, with bearings and packings well adjusted. For boats a smaller percentage is probable; Mr. Isherwood gave about 3 per cent. as the dead-load friction for the launch experimented with. The expression of the dead-load friction as a percentage of the maximum indicated horse-power, while generally adopted, is obviously not precise or complete.

* See his paper in the *Transactions* of the Institution of Naval Architects for 1876; also papers by Mr. Hall-Brown and Mr. Blechynden in the *Transactions* of the North-East Coast Institution of Engineers and Shipbuilders, 1889-91.

The late Mr. Froude suggested a method for determining constant friction from the results of progressive steam trials carried down to very low speeds. This method has been extensively employed, but has been found to give widely varying results, ranging from 5 to 15 per cent. of the gross indicated horse-power at full speed. It would appear, therefore, that the method, while of value, should not be implicitly trusted under the conditions of practice. Mr. Froude himself recognized this, and, to secure trustworthy results, designed for the Admiralty a special form of dynamometer, which was intended to be put in the place ordinarily occupied by the screw on the end of the shaft, in order to measure the power delivered for various rates of revolution. By means of this instrument, it was intended to determine both the dead-load friction and the working-load friction. The instrument was partly constructed at the date of Mr. Froude's death. It was subsequently completed, and a few trials made with it under the direction of Mr. R. E. Froude. Up to the present time, however, it has not been possible to carry the experiments very far, owing to more pressing work having to be done, and to difficulties in finding vessels both suitable and available for the trials.* Apart from actual measurements of the power delivered to the propellers, estimates, however carefully made, must be open to some doubt.

Since the dead-load friction represents a constant mean pressure on each square inch of the piston area, its relative importance increases as the speed of a steamer decreases. In war-ships, which usually cruise at speeds much below their full speeds, this is specially important. In Mr. Isherwood's experiments, while the dead-load friction represented less than 3 per cent. of the total indicated horse-power at 8.5 knots, it exceeded 9 per cent. of the indicated horse-power at 5 knots. In the trials on the *Iris*, it was shown that at 18 knots' speed the dead-load friction absorbed 8 per cent. of the indicated horse-power (7500 H.P.). At 9 knots, only about 800 indicated horse-power was required to drive the ship, and about 30 per cent. of that power was absorbed by dead-load friction. At still lower speeds, the relative importance of this friction increased. Various suggestions have been made in order to diminish these frictional losses at low cruising speeds. Most of them involve the subdivision of the machinery, or plans for throwing certain portions of the engines out of work when ships are proceeding at low speeds. This matter is further discussed in Chapter XVI.

Less information is available respecting friction due to the working load than has been obtained respecting dead-load friction. For

* A description of the dynamometer, and the principles of its design, will be found in the *Proceedings* of the Institution of Mechanical Engineers for 1877.

the experimental steam-launch, Mr. Isherwood fixed about 7 per cent. of the maximum indicated horse-power, or 7.5 per cent. of that horse-power less the power for constant friction, as the friction of the load. This value has been adopted by other engineers for engines of large power, but, so far as can be seen, without experimental verification. The late Mr. Froude, as a rough approximation, assumed the friction of the load at full power to be about equal to the dead-load friction, which would represent, on the basis of the statement made above, about 8 per cent. of the indicated horse-power at full speed. This agrees fairly well with the assumption that the total waste work between the cylinders and the propeller in a well-designed and carefully adjusted marine engine aggregates about 15 to 20 per cent. of the indicated horse-power. The subject obviously requires fuller experimental investigation, and dynamometric trials would settle many doubtful points.

Common experience shows that unless care is taken in the adjustment of the moving parts of the machinery and shafting, as well as in the due proportioning of bearing surfaces to the loads and speeds, the waste-work on friction may very greatly exceed the values given above. These losses are preventable, and need not be further dwelt upon.

Waste Work and Augmentation of Resistance due to Action of Propellers.—Accepting the waste work on the mechanism as 15 to 20 per cent. of the indicated horse-power at full speed, there remains to be accounted for about 30 to 35 per cent., if the standard value of the propulsive coefficient is taken at 50. This represents the waste work due to the action of the propeller. In Chapter XVI. the efficiency of screw propellers is discussed. Here it will suffice to point out the principal causes of loss. Obviously when a screw is rotating in water and delivering thrust, its blades must experience frictional and edgewise resistances of a more or less serious nature. In the *Greyhound* experiments it was found that when the two-bladed screw revolved freely as the ship moved ahead at 10 knots, the additional resistance amounted to 11 per cent. of the net resistance without the screw. In Mr. Isherwood's experiments on a steam-launch, the corresponding increase in resistance produced by the free revolution of different screws varied from $8\frac{1}{2}$ to 21 per cent. of the net resistance, the higher values occurring with experimental screws having the larger number of blades and greater blade area. For the despatch vessel *Iris* it was estimated, on the best data available as to coefficients of friction, that at full speed the waste work on the screws might vary as widely as from 6 to 20 per cent. of the work represented by indicated horse-power at the full speed, according to the pattern of screw used and the number of blades.

The action of propellers also produces augmentation of the resistance corresponding to the condition of being towed at a given speed. For screws the augmentation may be considerable. Its value depends chiefly upon the form of the stern of a ship, her speed, and the dimensions, number, and position of the screws. Mr. Isherwood, on his steam-launch with a single screw, found the augmentation to be about 11 per cent. at $7\frac{1}{2}$ knots. Mr. Yarrow found it to be $16\frac{1}{2}$ per cent. in his torpedo-boat. For ships with thick stern-posts and full forms, with single screws in the usual position, the late Mr. Froude considered 40 per cent. a fair value for augmentation, the rudder-posts representing about 10 per cent. The late Dr. Tideman made numerous experiments of a similar character on models, and found considerable variations in the augmentation with ships of different forms. Subsequent experiments have shown that in single-screw ships the augmentation varied from 20 to 40 per cent., the lower value corresponding to the finer forms. For twin-screw ships the augmentation varied from 25 per cent. in full ships to 6 per cent. in very fine ships. In some torpedo vessels of very high speed, with twin-screws placed well clear of the hull, the augmentation has been only 2 to 3 per cent. The explanations given on p. 450 as to the movement of water in the wake of ships when towed, will make it clear why there are such considerable differences in the augmentation occurring with twin and single screws. They will also assist to an understanding of the experimental results obtained by the late Mr. Froude. He found that when a single screw was placed about 30 per cent. of the extreme breadth of a ship clear of the stern, the augmentation was only one-fifth as great as when the screw occupied its ordinary position. It will be shown hereafter that such a change of position, while it reduces augmentation, also lessens the utilization by the propeller of the energy in the frictional wake. In fact, the probability is that the gain in one direction is practically neutralized by loss in the other.

Experiments show that the efficiency of a well-designed screw working under favourable conditions does not exceed 70 per cent. Frequently a lower efficiency is obtained. If 80 per cent. be taken as a fair measure of the efficiency of the mechanism, then it will be seen that with a fairly good efficiency of the screw (allowing for both augmentation of resistance and utilization of wake), a propulsive coefficient of 50 is not unreasonable.

CHAPTER XIV.

PROGRESS IN MARINE ENGINEERING—ITS INFLUENCE UPON STEAMSHIP DESIGN.

IN order to understand the influence which improvements in marine engineering have had upon steamship construction, it is necessary to obtain a general idea of the lines upon which that progress has proceeded. The changes introduced into marine engines and boilers in recent years are most remarkable. Their effect upon weight and coal consumption requires to be noticed, since this is a matter of importance to shipowners and shipbuilders. Without entering into technical details, which find their proper place in engineering treatises, it is proposed, therefore, to sketch briefly the principal advances that have been made, and to indicate the various types of propelling apparatus now placed at the service of the naval architect by the marine engineer.*

Increase in steam pressure has been the chief aid to progress in marine engineering. The extent of that increase will be gathered from the following statement of practice in the Royal Navy. Up to 1850 the load on safety-valves, as a rule, was not more than 10 lbs. per square inch. Ten years later the corresponding load was 20 lbs. In 1865 it had risen to 30 lbs. About 1870 the load had been increased to 60 lbs., in association with engines on the "compound" principle. By successive steps, loads of 90, 110, and 130 lbs. per square inch were adopted during the next fifteen years. In 1885 triple expansion engines were introduced into her Majesty's ships, and the loads on the safety-valves have

* Readers desirous of further studying this subject may refer with advantage to the following publications: "The Marine Steam-Engine," by the late Mr. Sennett; "Manual of Marine Engineering," by Mr. Seaton; the *Proceedings* of the Institution of Mechanical Engineers

for 1872, 1881, and 1891; the *Transactions* of the Institution of Naval Architects for 1888, 1889, and 1892; and the *Transactions* of the North-East Coast Institution of Shipbuilders and Engineers, 1887-92.

since gradually risen to 150 or 160 lbs. per square inch with boilers of ordinary type.

The mercantile marine has usually been in advance of the war-fleet in the use of higher steam-pressures. A careful analysis has given the following figures. In 1872 the average boiler pressures (load on safety-valves) of a number of typical merchant steamers was 52·4 lbs. per square inch; in 1881 the corresponding average was 77·4 lbs., and in 1891, 158·5 lbs.* Pressures of 200 lbs. per square inch have been employed in some cases with cylindrical boilers of ordinary type and "quadruple" expansion engines. In a few instances, with special forms of "tubulous" or "water-tube" boilers, pressures of 210 to 400 lbs. per square inch have been adopted. The last-mentioned pressure must be considered experimental under present conditions.

This considerable increase in steam pressure has resulted in great economies in coal consumption and has been in other respects advantageous. It would be out of place here to enter into a discussion of the laws of thermo-dynamics, which prove these results to be necessary consequences of increase in steam pressure and the accompanying increased rate of expansion of steam in the cylinders. The essential facts in the generation and use of steam may be briefly enumerated, however, in order that the principal causes of economy may be understood.

The efficient combustion of coal in a boiler demands careful stoking and a proper supply of air. Subject to the fulfilment of these conditions, the combustion of each pound of coal produces a certain "total heat of combustion," dependent upon the quality and chemical composition of the coal. This total heat of combustion is expressed in "thermal units" of definite value, which (according to Joule's law) are convertible into units of "mechanical work." When coal is burnt on the fire-grates of a boiler, the intention is, of course, to evaporate water contained in the boiler and to convert it into steam of a given pressure. Necessarily there are certain losses from the total heat of combustion of the number of pounds of coal burnt, say, in each hour. These losses chiefly result from radiation, conduction, the waste heat of gases passing up the funnel, and imperfect combustion due to inefficient stoking or air-supply. All these sources of loss have been carefully investigated, and much has been done to minimize their amount. That portion of the total heat of combustion which is applied to the evaporation of the water in the boilers produces steam of certain pressures and temperatures in certain

* See Mr. Blechynden's paper in the *Proceedings* of the Institution of Mechanical Engineers for 1891.

quantities per hour. Knowing the pressure of the steam, "the total heat of evaporation" of each pound of steam can be expressed in thermal units. It has thus been shown that the total heat of evaporation per pound of steam increases but slowly with increase in pressure. For a pressure of 30 lbs. per square inch on the boiler (a load of about 15 lbs. per square inch on the safety-valves), the total heat of evaporation of a pound of steam is 1157 thermal units; whereas for a pressure of about 160 lbs. per square inch it is only 1190 units. Consequently, if all other things remained constant, the number of pounds of steam evaporated by the combustion of a pound of coal would be practically the same for all pressures that have been used in marine boilers, say from 20 up to 200 lbs. per square inch load on the safety-valves. In practice, other things have not remained constant. As pressures have increased, changes have necessarily been made in the types of boilers and furnaces. These changes have affected the efficiencies of combustion and evaporation, and so have influenced the rate of evaporation per pound of coal burnt on the grates. Still the theoretical result, as above stated, even when modified by the conditions of practice, is of great importance in its bearing on the use of higher steam-pressures. A certain weight of steam of high pressure can be produced with only a small increase in the weight of coal required to produce an equal weight of steam at lower pressure. The higher pressure is accompanied by higher temperature, and has the capacity for performing more mechanical work during expansion to a given minimum pressure and temperature.

This higher rate of expansion in the cylinders is the great source of economy with increased steam pressures. The steps performed in using the steam are as follow: First, a certain volume of steam at the full initial pressure is admitted into the high-pressure cylinder, the piston of which performs a certain portion of the stroke under this full pressure. Next, the volume of steam so admitted is allowed to expand until it fills the high-pressure cylinder, after which it passes into other cylinders and completes its expansion. In a compound engine there are two stages of expansion, although in engines of large power there are frequently two low-pressure cylinders. In a triple expansion engine there are three stages. For a given engine the weight of steam used per stroke can be calculated from the volume of the cylinder or cylinders, when the terminal pressure at the end of the stroke has been ascertained by the indicator diagram. The communication with the condenser is opened when the expansion is completed, and the steam passes out of the cylinder into the condenser. Upon the efficiency of the condenser, measured by its so-called "vacuum," depends the "back pressure" in the cylinders during the return stroke. This back

pressure has to be deducted from the mean steam pressure in order to obtain the effective mean pressure used in calculating the indicated horse-power by the formula given on p. 538. The mechanical work which can be done by the expansion of steam may be expressed in terms of the range of temperature between the initial and terminal conditions, due allowance being made for back pressure. Consequently, for each pound of steam generated in the boilers and used in the cylinders, an increase in the initial pressure and temperature, if associated with a practically constant terminal pressure—that is to say, with a greater ratio of expansion—enables more mechanical work to be performed. It has been shown that in the boiler practically the same weight of coal has to be burnt to evaporate this pound of steam at high or low pressure. Hence it follows that with higher initial pressure and greater ratio of expansion, back pressure being constant, a higher mean effective pressure on the pistons is obtained during each stroke, and the indicated horse-power is increased for a given expenditure of coal.*

Efficiency in the condensers and reduction of back pressure will be seen to have an important influence upon the effective mean pressure and the work done. The introduction of surface condensation has been of great importance. The sea-water used to condense the steam is then kept separate from the steam; comparatively pure water is obtained by condensation, and is available for further use in the boilers. Experience proves that the use of pure fresh water is essential to continued efficiency in boilers generating steam of high pressures. Unavoidable losses of steam occur in service. To make up for these losses evaporators and distillers are now universally adopted, and in many cases reserves of fresh water for use in boilers are carried in special tanks or in compartments of the double bottom.

Further economy is realized by means of "feed-heaters," utilizing what would otherwise be "waste heat" in order to raise the temperature of the feed-water supplied to the boilers. By "superheating" the steam, jacketing cylinders to prevent liquefaction, and many other devices of which no account can be given here, engineers are constantly endeavouring to reduce the losses incidental to the use of steam, and to lessen the expenditure of coal.

* In the "Marine Steam-Engine" the late Mr. Sennett has dealt with this subject at length in a popular manner. From his illustrations the following figures may be taken. Steam is supposed to expand in a single cylinder with a terminal pressure of 10 lbs. per square inch (absolute) and a back pressure of 3 lbs. (absolute). For an initial

pressure of 40 lbs. per square inch and ratio of expansion 3·6, let the mechanical work done during expansion be called 100. Then for an initial pressure of 100 lbs. and ratio of expansion 8·4 the corresponding work would be 186, and for 200 lbs. initial pressure and ratio of expansion 15·5 the corresponding work would be 258.

With increase in steam pressures successive stages of expansion have been introduced. Up to 30 lbs. per square inch, all the expansion was performed in the cylinders to which admission took place. These are termed "simple" or "single" expansion engines. Two stages of expansion were adopted with 60 lbs. per square inch, the engines being on the "compound" principle. With higher pressures "triple" expansion is employed. "Quadruple" expansion has now many advocates, but with pressures of 180 to 200 lbs. per square inch triple expansion has so far maintained itself in general favour. In all these plans the fundamental idea is to restrict within moderate limits the range of temperature in each stage of expansion, and thus to reduce the losses inevitable when there is a great range of temperature in a single cylinder, which is alternately open to supply and exhaust at either end.

There are many different arrangements of the cylinders and cranks, even with a given system of expansion. Compound engines of moderate power commonly have only two cranks and two cylinders; whereas with engines of large power, there are often two low-pressure cylinders and three cranks. The latter plan has given excellent results, and has been adopted also, so far as the number of cranks and cylinders is concerned, for many triple expansion engines. Some triple expansion engines have only two cranks, two of the cylinders being placed in line, "tandem" fashion. Others have four cylinders—two low-pressure—and four cranks. Another plan has five cylinders on three cranks, two pairs of cylinders being arranged tandem fashion. The last-mentioned plan has been adopted in the *Campania* and *Lucania* of the Cunard Line, for two sets of engines developing 30,000 H.P. Quadruple expansion engines demand the use of at least four cylinders, but the numbers of cylinders and of cranks are varied by different designers. These arrangements, while they are primarily the concern of the marine engineer, have a great interest for the naval architect and shipowner, because they affect the space occupied by the machinery, and influence the possible vibration of the ship's structure.

Increased rate of revolution and piston speed is another striking feature in engineering progress, tending to economy in the weight of machinery in proportion to the power developed, as explained on p. 538. The formula there given shows that indicated horse-power depends upon number of revolutions, area of pistons, and length of stroke. Increase in the number of revolutions, therefore, enables a given horse-power to be produced from cylinders of less capacity; and this reduced capacity may be realized either by smaller area of pistons or shorter stroke. Higher speed of piston and greater rate of revolution have been very marked in recent practice. In the

Royal Navy up to 1860, about 400 feet per minute was a fair piston speed. This was gradually increased to 550 or 650 feet. Since 1880 piston speeds of 800 to 950 feet per minute have been attained when developing maximum powers on steam trials. In ordinary service lower speeds, of course, would be obtained. Under the conditions of ordinary service in the mercantile marine, revolutions and piston speeds have been very sensibly increased in recent years. Mr. Blechynden states, as the result of the analysis of a large number of representative screw-steamers, that between 1872 and 1891 the average number of revolutions per minute increased from 56 to 64, and the average piston speeds from 376 to 529 feet per minute. In swift passenger steamers the length of stroke is greater than in war-ships, and the number of revolutions is not so high; but the piston speeds are fully as great as those above mentioned for war-ships. Battle-ships and large cruisers in the Royal Navy have engines of about 4 to $4\frac{1}{2}$ feet stroke, with about 100 to 105 revolutions at maximum power on trial, and about 80 revolutions for full speed when continuously steaming at sea. Passenger-steamers of recent design have strokes of 5 to 6 feet, and revolutions at sea of 70 to 85 per minute. For cargo-steamers strokes of $3\frac{1}{4}$ to $4\frac{1}{2}$ feet are used, with revolutions ranging from 65 to 75 per minute. Proposals have been made by eminent engineers to introduce quicker running engines in cargo-steamers, and it is possible some change may be made.* There is, however, a close connection between the rate of revolution of the engines and the efficiency of screw propellers, and this will always influence engine design in ships of low speed with large carrying capacity. At the present time (1898) piston speeds of about 1000 feet per minute have been regarded as a maximum for large marine engines.

In the earlier period of screw-propulsion, when slow-running engines were in use, gearing was employed in order to increase the speed of revolution of the screws. Now that quick-running engines have been introduced, and their capabilities demonstrated in torpedo craft and cruisers, proposals have been made to use gearing in order to reduce the revolutions of the propellers below the revolutions of the engines. It is suggested that sensible savings might thus be effected in the weight of the engines developing a certain horsepower, while the revolutions of the screws might be adjusted so as to secure maximum efficiency. The suggestion clearly is not impracticable, but so far no use appears to have been made of it, and there are unavoidable disadvantages associated with gearing.

* See papers by Mr. Boyd and Mr. of the North-East Coast Institution of
Hall-Brown in vol. 6 of the *Transactions* Engineers and Shipbuilders.

Two items, as explained above, are involved in piston speed, viz. rate of revolution and stroke. Between the cases of a torpedo-boat engine making 350 revolutions per minute with a stroke of 18 inches, that of a cruiser making 140 revolutions per minute with a stroke of 42 inches, and that of a Trans-Atlantic steamer making 80 to 85 revolutions per minute with 66 inches stroke, there are very obvious differences which would not be represented by mere statements of the piston speeds, although they would have to be recognized by the designers of the engines, and might have an important bearing upon the vibration of the ship's structure.

High piston speeds demand excellence of materials and workmanship, ample bearing surfaces, and a proper margin of strength. The extensive use of steel instead of iron, both in forgings and castings, has been of great value to engineers in carrying out improvements in the moving parts and framing. Savings in weight have been effected without diminution in strength, but often at increased cost, by means of hollow shafting, especial forms of engine-framing, and close attention to the design of details. The extended use of twin-screws in ships of large engine power has enabled the sizes of cylinders and weights of moving parts to be kept down. Progress in steel manufacture also has greatly aided the marine engineer, as well as the shipbuilder, both in the direction of substituting a stronger material for iron, and in giving to the user his material in sectional forms better adapted to the association of strength with lightness.

Types of Marine Boilers.—New types of boilers have been devised for the purpose of generating steam of higher pressures. In this direction great activity is still being displayed. At first, with steam pressures below 10 lbs. per square inch, the boilers used had internal flues. Tubular boilers were next introduced, with flat surfaces and approximately box-shaped; hence they are commonly described as the "box-tubular" type. Their distinctive feature was the employment of groups of small tubes, through which the products of combustion passed on their way from the furnaces to the uptakes. These tubes were surrounded by the water-space, and were ordinarily placed above the tops of the furnaces, so that they formed an important part of the heating surface. This type of boiler remained in general use in the Royal Navy for fully twenty years, and proved satisfactory for steam pressures of about 30 lbs. per square inch. They depended entirely for strength against internal pressure on the stays fitted between the flat surfaces. When steam pressures rose to 60 lbs. per square inch, the box form had to be abandoned in favour of cylindrical boilers (usually circular, but sometimes oval in cross-section) fitted with circular furnaces. The arrangements of

tubes remained much as in the earlier types. The cylindrical type (sometimes described as the "tank" boiler) continues in use, although steam pressures of 180 to 200 lbs. are now employed. In the mercantile marine they are almost universally fitted, and in war-ships they are employed except in special classes. For continuous service they have proved very efficient. On the other hand, they carry comparatively large weights of water, and are not adapted for the quick raising of steam.

The construction of cylindrical boilers of very large size, capable of working under high steam pressures, has been made possible, in great measure, by the remarkable extensions of steel-manufacture in recent years. Steel plates of very large dimensions and suitable thickness can now be obtained. That material has also facilitated the production of improved forms of furnaces, front plates, and combustion chambers. With steel the several parts of boilers can be flanged or bent into forms well adapted for combination, and for resisting pressure, to an extent impossible with iron. Moreover, in boiler-construction machine work has been substituted for manual labour in many directions, such as flanging, bending, drilling, riveting, and caulking. Apart from these mechanical devices, the progress realized in the use of high steam pressures with this type of boiler could not have been made.

The "locomotive" type of boiler has been used extensively in vessels of the torpedo-flotilla in recent years, and in most cases has been associated with high steam pressures, and very quick running engines. A few larger ships of war have been fitted with groups of locomotive boilers, when it was desired to economize weight as much as possible. Compared with cylindrical boilers, the locomotive type is very light for the power developed. Single locomotive boilers fitted in torpedo-boats have given 45 to 50 H.P. (indicated) per ton of boiler and water in boiler, on trials of three or four hours' duration under forced draught. Groups of locomotive boilers have given from 30 to 35 H.P. on similar trials, with moderate forced draught. Higher results are claimed by some foreign engineers for groups of locomotive boilers. Groups of cylindrical boilers worked for 3 or 4 hours, under the highest forced draught considered suitable for the type, have given 20 to 25 H.P. per ton of boiler and water in boilers. It is within the truth to say that, apart from the use of the locomotive boiler, before water-tube boilers were introduced, the small swift classes of torpedo-boats, and torpedo-gunboats could not have been produced.

Difficulties have arisen in some cases where groups of locomotive boilers have been used. The torpedo-ram *Polyphemus* of the Royal Navy was originally fitted with locomotive boilers, which were

removed after many trials, cylindrical boilers being substituted. Less serious, but still considerable, difficulties have been met with in vessels of the torpedo-gunboat class both in this country and abroad, and a more moderate indicated horse-power than was first anticipated has had to be accepted. The qualities which ensure to locomotive boilers fitted in ships great evaporative power appear to make their management more difficult than that of cylindrical boilers, when groups of boilers have to be worked. The figures above stated indicate that the results obtained with a single boiler are very sensibly better than the results obtained with groups, and experience shows this to be true generally.

Locomotive boilers have been tried in seagoing ships of the mercantile marine, and in a few foreign cruisers designed for general sea-service. Under these conditions the type has not proved successful. The propriety of fitting a combination of cylindrical and locomotive boilers was also considered many years ago in the Admiralty, but the difficulties with the *Polyphemus*' boilers caused the plan to be dropped. In that instance, the desire was to economize as much as possible the weight of boilers which would ordinarily be held in reserve. War-ships at cruising speeds usually develop only 10 to 15 per cent. of their maximum power. This reserve is only drawn upon on the occasions when full speed is required. The Italian battle-ship *Lepanto* is actually fitted on this plan, and the results are said to be satisfactory.*

In recent practice "water-tube" boilers have become formidable rivals of the locomotive type, even in the small swift vessels, where the latter have been almost exclusively used for ten years past. The distinctive feature in water-tube boilers is the circulation of the water and steam within tubes, which are acted upon externally by the products of combustion. In these boilers the weight of water is relatively small, the construction is admirably adapted for high steam pressures, steam can be very quickly raised and kept under command, and there is a considerable economy in weight relatively to power developed. Some boilers of the type are suitable for the use of forced draught; others are not. Many varieties have been tried for land service, with considerable success. Experimental water-tube boilers were also tried many years ago in mercantile steamers, with unsatisfactory results. In recent years there has been a renewal of the experiment under new conditions, including the use of fresh water in the boilers. The results have been satisfactory on the whole, and there is reason to anticipate an extended use of water-

* See a paper by Colonel Soliani in the *Transactions* of the Institution of Naval Architects for 1889.

tube boilers.* In France the type is, at present, being employed for all classes of war-ships in construction, and many merchant ships are similarly fitted. Considerable experience has been obtained in this country with boilers of the type designed by the principal builders of torpedo-boats. For some years Messrs. Thornycroft have almost exclusively used water-tube boilers, in preference to locomotive.

It is difficult to obtain exact information respecting the relative weights of locomotive and water-tube boilers. Mr. Thornycroft has claimed, for a single water-tube boiler with moderate forced draught, a development of 68 indicated horse-power per ton of boilers, water, and boiler-room fittings. He estimated this as a gain of about 40 per cent. for the water-tube type. Advocates of the locomotive boiler do not admit such a great superiority.

Groups of water-tube boilers do not appear to realize such a high performance as is claimed for single boilers. A valuable series of trials with the Thornycroft type were conducted in the Danish cruiser *Geiser* during 1892. From the published official report, it appears that with eight boilers, worked under an air pressure of less than 1 inch of water, about 30 H.P. were obtained per ton of boilers, water, etc. With 2 inches of air pressure it was estimated that about 40 to 50 per cent. more power would have been realized, say 45 H.P. per ton as a maximum. This is only *two-thirds* as great power as was claimed for a single boiler. The total indicated horse-power in the *Geiser* was 3157 H.P. for a total boiler-room weight of 108 tons. Comparing this with practically the same weight in a torpedo-gunboat of the Royal Navy fitted with four locomotive boilers, and developing about 2600 H.P. for 1 inch of air pressure, the water-tube boilers have an advantage of about 20 per cent. Probably about the same relative superiority would be maintained with 2 inches of air pressure.

Another series of trials with boilers of the Thornycroft type was made in 1893 on board the torpedo-gunboat *Speedy* of the Royal Navy. Under an air pressure in the stoke-holds of about *six-tenths* of an inch of water, about 28 I.H.P. were obtained per ton of boiler-room weights during a trial of eight hours. With an air pressure of 1.7 inch of water, about 43 I.H.P. per ton were obtained during a trial of three hours. As compared with a group of loco-

* For particulars of the past history and present position of this type, reference may be made to the following publications: *Transactions* of the Institution of Naval Architects for 1876 and 1889; *Proceedings* of the Institution of Civil

Engineers for 1889-90; *Journal* of the Royal United Service Institution for January, 1891, and February, 1893. An excellent report on this type of boiler as exemplified at the Paris Exhibition of 1889 was prepared by M. de Maupeou.

tive boilers fitted in a sister ship, those results showed a gain of over 30 per cent. for the water-tube boilers.

Definite information in regard to the capabilities of water-tube boilers will be largely increased at an early date. In the French Navy several types are under trial, some of them in large ships where it is proposed to develop from 14,000 to 18,000 H.P. In the Royal Navy, various types of water-tube boilers are being fitted in vessels building for the torpedo flotilla; and the cruisers of the *Powerful* class are to have water-tube boilers developing about 25,000 H.P.

Several other systems of water-tube boilers are to be tried in vessels now building for the torpedo flotilla. The results will probably have a marked influence on future practice.

As applied to merchant ships for general sea-service, recent experience with water-tube boilers is limited, but not unsatisfactory on the whole. About 20 to 25 H.P. per ton of boiler-room weights is said to have been obtained over long periods with natural draught. This performance, if correctly reported, compares well with that mentioned above for cylindrical boilers under the highest forced draught thought suitable, which could be continued only for a few hours.

Cylindrical boilers with triple-expansion engines, working under natural draught, develop 16 to 18 H.P. per ton of boilers and water in boilers, which is about 25 per cent. less than is claimed for the water-tube boilers under the same conditions of draught. This claim is not admitted absolutely by advocates of the cylindrical type, who consider that, when both space and weight are taken into account, that type has still much in its favour for marine purposes and long-distance steaming.

The Danish Admiralty has constructed a sister ship to the *Geiser*, with six cylindrical boilers, intended to give the same indicated horse-power with natural draught as the water-tube boilers give with about 1 inch of air pressure. This is hardly a fair comparison, since the cylindrical boilers could be forced to a moderate extent without difficulty. The relative boiler-room weights are said to be 168 tons and 108 tons. Subsequent experience with these two vessels should give much valuable information.

Besides their relative lightness, water-tube boilers have some incidental advantages over the other types. They can be put together on board ship, or repaired without removal. Much smaller openings are needed in the decks for getting the boilers into or out of place. The operations of boiler-making are less onerous than with the other types, and lighter plant suffices. But their greatest advantage, especially in war-ships, will be found in their capacity for raising steam quickly. The most important question remaining to

be determined by experience, and which experience alone can resolve, is the comparative durability of water-tube boilers. Cylindrical boilers, properly treated, remain unaltered in efficiency for long periods. Boilers of the type have continuously worked for twenty years at full pressure. In the earlier trials with water-tube boilers made many years ago two principal difficulties arose: defective circulation and rapid pitting or corrosion of the tubes. The first difficulty has been overcome in later types. Pitting and corrosion of tubes have not been as thoroughly dealt with, although it is probable these risks have been much diminished. The use of fresh water only, and other devices for preventing deposits on the inner surfaces of the tubes; arrangements for keeping clean the outer surfaces, and preventing overheating in certain parts of boilers; improvements in the manufacture of tubes, and modes of protecting them by zincing or other coatings;—all tend to give greater durability. The failure of a tube, however, practically puts the whole boiler temporarily out of use until it can be reached and plugged. In the design of water-tube boilers, therefore, it is recognized that ease of access for examination and repairs is an important feature. Further, it is preferred to subdivide the total steam-generating power more extensively, and to have a larger number of water-tube boilers than would be adopted if cylindrical boilers were fitted. In this way the temporary loss of a single boiler is less felt if repairs are necessary; and in war-ships at cruising speeds only a limited number of the boilers need be at work.

METHODS OF ACCELERATING EVAPORATION IN BOILERS.

The evaporative power of boilers has been shown to depend greatly upon the quantity of coal burnt per hour, and upon the supply of air being appropriately adjusted so as to secure efficient combustion of the coal. Ordinarily, in steamships the funnels are depended upon for creating a "draught" of air into the furnaces, and the supply of fresh air is obtained by means of ventilators, or "downcast" shafts, leading from the upper decks to the stokeholds. At a very early period in steam navigation cases occurred in which it was found necessary to supplement the natural (or funnel) draught by appliances intended to quicken that draught and increase the air supply. In recent years renewed attention has been given to the subject, and many plans have been tried.

Steam Blast.—Until 1880 war-ships were commonly fitted with this means of quickening the draught. Steam jets could be delivered at the base of the funnel, and the rate of combustion increased from 40 to 50 per cent. for short periods. This involved a very consider-

able waste of steam, and was prejudicial to economy in coal consumption. While the rate of combustion was so greatly accelerated, the indicated horse-power was increased only about 15 per cent. In other words, the coal consumed per indicated horse-power per hour was increased about *one-third*, while the increase in horse-power was only about *one-seventh* of the power realized with natural draught. As higher steam pressures were used, fresh water in the boilers became essential, and the objections to this system became more serious. It has now fallen into disuse.

Air Blast.—Instead of steam jets M. Bertin suggested the use of jets of compressed air. In this way the draught could be quickened, and the steam used in the engine of the air-compressors could be condensed. On trial it was found that an increase of 40 per cent. could be obtained upon the indicated horse-power realized with natural draught, with about 20 per cent. increase on the coal burnt per indicated horse-power per hour.* After these trials it was preferred to use "closed stoke-holds" in the ships of the French Navy, and to adopt forced draught.

Induced Draught.—Instead of using steam or air jets at the base of the funnels, it has been more than once proposed to "induce" the draught by means of fans placed in the same position, and driven by steam-engines. Mr. Martin has worked out one of these plans, and trials have been made with it in the Royal Navy. Other inventors have proceeded on similar lines, developing certain novel features. Messrs. John Brown and Co., of Sheffield, while retaining the fan in the uptake, have arranged that the air supplied to the furnaces shall pass through a series of tubes placed in the uptakes. It is asserted, as the result of experiment, that this utilization of heat which would otherwise be wasted, and consequent heating of the air before it enters the furnaces, favour both the rate of combustion and the economy of coal consumption. Important experiments are now in progress with this system on several large steamships. One advantage claimed for it is the possibility of obtaining good evaporation with inferior qualities of coal. It is also asserted that these results can be maintained over long periods without leakage of tubes or other injury to cylindrical boilers. With all plans of induced draught the stoke-holds remain open, and all the operations therein proceed as under ordinary funnel draught.

Forced Draught.—Under this designation several plans may be included, which have in common the delivery of air under pressure to the furnaces by means of steam-driven fans or blowers. These

* See a Memoir by M. Bertin in the *Proceedings* of the Societ  d'Encouragement pour l'Industrie Nationale, 1877.

plans may be arranged in two classes: the "closed ash-pit," and the "closed stoke-hold."

The "closed ash-pit" system was employed in some of the earliest steamers. In recent years it has been revived and extended; in some instances for the purpose of enabling inferior qualities of coal to be used, and in others to increase the evaporative performance of the boilers either in ordinary work or under special circumstances. In all cases the stoke-holds remain open as with natural draught, but the ash-pits are closed, and air is delivered to the furnaces either below the fires, or both below and above, or below and in the combustion chambers.

The "Ferrando system" has been extensively used in cargo-steamers, and is stated to have given excellent results, both as regards economical working and good evaporative power when using cheap and inferior qualities of coal. Its distinctive features are the employment of special firebars, and the supply of air to the ash-pits below the fires. The system worked out by Mr. Howden has been applied to many merchant steamers, including some of the largest and fastest vessels afloat. It embodies arrangements of the character mentioned above, for utilizing heat, that would otherwise be wasted, in raising the temperature of the air supplied to the furnaces. There are special fittings by means of which the amount and pressure of the air can be regulated before admission to the furnaces both above and below the fires. With this system it is alleged, on the basis of extensive experience, that large evaporative power can be combined with an economical rate of coal consumption, and the boiler-room weights reduced. When work has to be done on the fires, and the furnace doors are opened, the forced draught must be temporarily shut off. It is necessary also to make independent provision for the ventilation of the stoke-holds. These two features apply to all forced-draught systems with closed ash-pits.

The "closed stoke-hold" system has been extensively used in recent years. Its success in torpedo-boats led to its extension to larger war-ships, and it has also been applied in many steamers of the mercantile marine.* Each stoke-hold is made practically airtight, and powerful fans or blowers are used to deliver air into the closed stoke-holds, producing a sensible amount of pressure. As this air can only escape through the furnaces, the draught is "forced," more coal is burnt and more steam produced. In order to maintain the pressure while permitting entrance and egress, special "air-locks" have to be constructed. This closing of the stoke-holds and the

* See papers on this subject in the *Transactions* of the Institution of Naval Architects for 1883 and 1888.

difficulty of getting into or out of them have been objected to, and undoubtedly involve some inconveniences. On the other hand, there are certain advantages. All the operations of stoking, cleaning fires, etc., proceed as with natural draught and in open stoke-holds. The stoke-holds are kept comparatively cool and well ventilated by the same air supply as serves for the furnaces. It has been urged that the rush of cold air into the furnaces when the doors are opened for firing involves the danger of sudden chilling of some portions of the boiler, and of tube leakages. While there may be some risk of the kind, its magnitude has probably been over-estimated by opponents of the closed stoke-hold system. Undue forcing of the draught in order to increase the rates of combustion and evaporation is obviously unwise, since it may impair the efficiency of the boilers for subsequent service. Much depends upon the type of boiler used. In the Royal Navy it has been the rule, with cylindrical boilers, to limit the air-pressure in the stoke-holds, when proceeding at full speed for long periods, to $\frac{1}{2}$ inch of water. The term "natural draught" is now usually applied to this steaming condition with stoke-holds closed and an air pressure not exceeding $\frac{1}{2}$ inch, which does not exceed what a tall funnel would give under favourable conditions. In some swift mail-steamers fitted on the closed stoke-hold system, air pressures of $\frac{3}{4}$ inch to 1 inch of water have been used for long periods without injury to cylindrical boilers. For short periods, as on the four hours' contractors' trials of her Majesty's ships, the stoke-holds were formerly put under an air pressure of 2 inches with cylindrical boilers. Now the upper limit is fixed at or about 1 inch of water. With 2 inches of air pressure the maximum indicated horse-power obtained has been from 60 to 70 per cent. above that obtained with natural draught. With 1 inch of air pressure, the corresponding increase is about 20 to 25 per cent. Exact determinations of the relative rates of coal consumption under natural and forced draught are wanting. Under the higher forced draught condition named, the coal burnt per indicated horse-power per hour would probably increase sensibly as compared with natural draught. Two causes account for this. First, forcing the draught and burning a much larger weight of coal would tend to be wasteful of fuel; second, the engines would be worked less expansively when using the larger quantities of steam. With moderate forced draught (1 inch of air pressure) it would appear that economy in coal consumption should be well maintained.

For groups of locomotive boilers, the rule of the Royal Navy is to permit an air pressure in the stoke-holds not exceeding 1 inch of water (as the so-called "natural draught") for full-speed continuous steaming on service, and 3 inches as the air pressure for contractors' 3-hour trials. Formerly it was thought not excessive to obtain 60 to

80 per cent. above the natural-draught development of power with high forced draught. The later practice is to be satisfied with about 40 per cent.

In torpedo-boats, each fitted with one large locomotive boiler, much higher stoke-hold pressures have been used without injury to the boilers. In some instances air pressures have reached 6 to 8 inches of water. This experience naturally leads to the remark that the air pressure in a stoke-hold is not the sole measure of the extent to which a boiler is or may be forced. Regard must be had to the heating surface of the boiler, the coal burnt, and the heat transmitted in a unit of time. For each type of boiler, experience is the best guide in deciding on the limit of forcing consistent with continued efficiency.

While the locomotive boiler is better adapted to forcing than the cylindrical, the higher air pressures used with that type involve a higher rate of expenditure of coal per indicated horse-power per hour. As already stated, the locomotive type is used only in classes of war-ships where the accomplishment of high speeds for short periods is a matter of the greatest importance. Economy of coal consumption necessarily has to be sacrificed at such times. Under ordinary working conditions the locomotive type compares much more favourably with the cylindrical in its rate of coal consumption.

Some types of water-tube boilers are not adapted for high forced draught. Others have been forced to a considerable extent without injury. So far as experience has gone, however, the preference is for moderate forcing under service conditions with such boilers.

Fan-draught: Open Stoke-holds.—In many cases powerful fans have been fitted, delivering air to the stoke-holds independently of closing either the stoke-holds or the ash-pits. It is thus possible to increase the evaporative power of boilers very sensible as compared with natural draught, more especially in cases where the supply of air is made difficult by the necessity for having limited openings in decks, or indirect passages to the stoke-holds. Fan draught is also of great value under unfavourable conditions, such as hot weather, calms, or following winds, giving a command of steam not possible with funnel draught and ordinary ventilators.

All the methods of assisting draught above mentioned are of value within proper limits, and subject to the maintenance of the boilers in an efficient condition. In war-ships it may be of immense importance to obtain an increase of power or speed for a limited time. In merchant ships similar conditions may arise when in hot climates, saving a tide in entering port, or facing contrary winds. Ten years' experience in the Royal Navy has given much valuable information for future guidance, and has confirmed the view that

appliances for forcing or assisting draught, if employed within proper limits, are most valuable aids to efficiency.

WEIGHTS AND RATES OF COAL CONSUMPTION.

In concluding this brief and necessarily imperfect sketch of engineering progress, it may be of interest to present in a tabular form the weights, rates of coal consumption, and some other particulars of the types of propelling machinery still in use in the Royal Navy. An epitome of the history of marine engineering since 1860 is represented in ships remaining on the active list. Beginning with the earliest ironclads of the *Warrior* and *Minotaur* classes, and concluding with the latest battle-ships and cruisers with vertical triple-expansion engines, this table indicates clearly the advances to which reference has been made above. The indicated horse-powers used in estimating weights are those corresponding to the full-speed contract trials. For ships of recent date, fitted with forced-draught appliances, the results of the "natural draught" trials of eight hours' duration are used. It will be easy to estimate, from the particulars given on p. 562, how the proportion of weight to power would be reduced if the forced-draught developments were taken into account. The coal consumptions correspond to the full-speed condition. At lower cruising speeds in war-ships, the rates of coal consumption per indicated horse-power per hour are usually above those for full speed. For the earlier vessels the rates of coal consumption can only be regarded as approximately correct.*

WEIGHTS AND RATES OF COAL CONSUMPTION FOR WAR-SHIP MACHINERY.

Date.	Boiler pressure.	Type of			Piston speed.	Weight per indicated horse-power.	Rate of coal consumption per indicated horse-power per hour.
		Boiler.	Con-denser.	Engine.			
1850-1860	lbs. per sq. in. 20-25	Box-tubular	Jet	{ Simple-expansion : } { horizontal }	ft. per minute. 350-450	lbs. 380-400	lbs. 5-5½
1860-1870	30-35	Ditto	Surface	Ditto	500-650	330	8½-8¾
1870-1880	60-65	Cylindrical	Ditto	{ Compound hori- } { zontal or vertical }	550-650	360	2½
1880-1885	90-130	Ditto	Ditto	Ditto	600-800	310-330	2½
1885-1892	130-155	Ditto	Ditto	{ Triple-expansion : } { vertical }	700-900	260-300	2-2½
1890-1893	155	{ Locomotive : } { in groups }	Ditto	Ditto	800	150-180	2-2½
1890-1893	180-200	{ Locomotive : } { single large boiler }	Ditto	Ditto	900-1000	70-80	—

NOTE.—The particulars tabulated are for "natural-draught" trials, except for the single locomotive boiler in torpedo-boats, for which the trials are under forced draught. In the case of cylindrical boilers, air pressures not exceeding ½ inch of water, and with locomotive boilers not exceeding 1 inch, come under this category.

* For much fuller details see Mr. Durston's paper in the *Transactions* of the Institution of Naval Architects for 1892.

For merchant steamers it is customary to express the weight of machinery and rate of coal consumption in terms of the average horse-power indicated on service, and not on contractors' trials. Merchant ships work under much more uniform conditions of speed than war-ships, and are designed to steam at certain speeds (except for the influence of wind and weather) with certain maximum loads on board. Passenger-steamers are built to cover certain distances from port to port. War-ships, as explained above, have to perform their ordinary duties at very low speeds and powers, compared with the full speeds and powers which they are capable of developing. Hence it is usual to take the contractors' trials as the fairest standard when comparing different types of war-ships. When comparisons are made between war and merchant ships, however, it is necessary to estimate the seagoing performances of the former in terms of the trial performances. According to the established practice of the Royal Navy, the *minimum* power which ought to be developed continuously as long as the coal lasts is 60 per cent. of that obtained on the natural-draught eight hours' trials. In many cases a higher percentage has been obtained, and in some ships the full specified natural-draught power has been realized on a 96 hours' trial at sea. Taking the ordinary estimate of 60 per cent., it will be seen from the foregoing table that the weight of propelling machinery in modern war-ships fitted with triple-expansion engines and cylindrical boilers varies from 400 to 500 lbs. per indicated horse-power for continuous steaming, an increase of two-thirds above the tabulated weights.

Turning to merchant ships, and using the same basis for estimating weights in terms of the average horse-power indicated on continuous steaming, it is found that considerable differences exist between different types of steamers. In a number of examples of cargo-carrying steamers of moderate speed worked under comparatively easy conditions, with low piston speeds, compound engines, and cylindrical boilers, the weights have varied from 480 to 500 lbs. per indicated horse-power. For triple-expansion engines in a number of similar ships, the corresponding weights have been from 450 to 470 lbs., and in a few cases 600 to 650 lbs. per indicated horse-power.* For fast passenger-steamers, weights of 400 to 500 lbs. per indicated horse-power have been common with triple-expansion engines and natural draught; while weights of 300 to 350 lbs. have occurred in steamers of very great power fitted with forced or assisted draught. It will be seen, therefore, that the latest practice in the Royal Navy

* See a paper by Mr. Hall in vol. iii. of the *Transactions* of the North-East Coast Institution of Engineers and Ship-builders; and Mr. Blechynden's paper above mentioned.

and that in the mercantile marine do not differ much when expressed on the same basis. It is generally assumed that war-ship machinery is much lighter than that in passenger-steamers; but the opinion is based upon the different modes of expressing the relation of weight to indicated horse-power. What has been said above as to the ordinary cruising speeds of war-ships being very low need not be repeated. But it involves, as a consequence, very small demands on either engines or boilers during the greater period of service of war-ships; whereas merchant ships are worked at uniformly high power in proportion to maximum capability. This constancy of condition in merchant ships, while it makes greater demands on the strength of the machinery, is advantageous in other respects. It favours economy in coal consumption, and tends to preserve in a highly efficient condition the bearings and all working parts of the mechanism.

Economy in Coal Consumption.—The principal sources of economy in coal consumption have been shown to consist in higher steam pressures, greater rates of expansion, and improved condensers. Other improvements have favoured economy, such as feed-heaters, steam jacketing, more efficient valves and valve gear, and better combustion of fuel. In the table on p. 564 are given the successive steps in increased economy. Since 1860 the rate of coal consumption has been diminished about 60 per cent. in her Majesty's ships. The use of the compound engine effected a saving of from 40 to 50 per cent., and the balance has been due to the triple-expansion engine. Starting from the compound engine, the use of triple expansion has effected an economy of about 18 to 20 per cent.

In the mercantile marine similar but greater economies have been effected. Average results for merchant ships on service are said to work out as follows: * In 1872, with compound engines and about $52\frac{1}{2}$ lbs. boiler pressure, the coal consumption was 2.11 lbs. per indicated horse-power per hour. In 1881, with compound engines and about $77\frac{1}{2}$ lbs. boiler pressure, the corresponding consumption was 1.828 lbs. In 1891, with triple-expansion engines and $158\frac{1}{2}$ lbs. boiler pressure, the consumption was 1.522 lbs. There is a great mass of evidence in support of the statement that with triple-expansion engines at the present time the consumption of coal per indicated horse-power per hour on service is from $1\frac{1}{2}$ to $1\frac{3}{4}$ lb., and in some instances is below $1\frac{1}{2}$ lb.†

* See Mr. Blechynden's paper above mentioned.

† See reports in the *Proceedings* of the Institution of Mechanical Engineers, 1889-93; of the Research Committee on Marine Engine trials. For an excellent

résumé of the facts respecting coal expenditure in war-ships, see a paper by Mr. Riley, R.N., in the *Journal* of the Royal United Service Institution for July, 1893.

Comparing these figures with those tabulated for war-ships, mercantile practice is seen to give superior economy, and no doubt does so. There are many reasons for this superior economy. The constancy of the conditions as to speed and power under which merchant ships work is an important factor. In such ships there is much greater freedom in arranging engines and boilers than can be obtained in war-ships, where considerations of armament and protection often hamper the designer. The boilers can be made more roomy, and combustion under natural draught more efficient. The steam can be worked more expansively under the conditions of full speed than it is ordinarily worked under similar conditions in war-ships. On the other hand, it must be stated that the figures given in the table for war-ships are based on a large number of trials, extending over considerable periods, and with the indicated horse-power accurately determined as well as the weight of coal burnt. Similar trials can hardly be carried out in merchant ships on service. The coal consumed on a voyage is known, of course, within narrow limits; but the average indicated horse-power is not accurately determined, and any over-estimate of that power would involve an under-estimate of the rate of coal consumption. Exact trials have been made, however, on merchant steamers by the Research Committee of the Institution of Mechanical Engineers and others, and these substantially confirm the results based on ordinary service.

For war-ships making long passages, much better results have been obtained than are shown in the table, which deals with averages. The *Thunderer*, for example, steamed at full sea-speed to Madeira and back, on a consumption of 1.66 lbs. of coal per indicated horse-power per hour—a result comparing well with mercantile practice. Equally good results have been obtained with other battle-ships and cruisers on long runs at high speed. Could everything in war-ships be adjusted so as to secure maximum economy at the full sea-speed as is possible in merchant ships, greater economy of coal would be obtained. This cannot be done, because of the great range of power over which war-ships have to work. At low speeds the rate of coal consumption is higher than at the full sea-speeds. The reasons for this are obvious, since engines capable of developing a certain maximum power only develop about 10 to 15 per cent. of that power at cruising speeds. Moreover, when cruising in company, war-ships are bound to keep a large reserve of steam available, which makes against economy. At cruising speeds, therefore, the rate of coal consumption per indicated horse-power is necessarily increased as compared with that at full sea-speed. The difference in the rates varies greatly in different ships. Sometimes it is about

10 to 15 per cent. greater at low than at full speeds; in other cases it is 20 to 30 per cent. greater.

For locomotive boilers the rate of coal consumption at the higher powers is usually somewhat greater than with cylindrical boilers, but the difference is small at lower powers. Results obtained with water-tube boilers of good type compare favourably with those for cylindrical boilers. In the Danish cruiser *Geiser*, Thornycroft boilers on an eight hours' trial burnt 1.77 lbs. of coal per indicated horse-power per hour, when developing about 80 per cent. of the full power. Similar results have been obtained in French cruisers with other types of water-tube boilers and triple-expansion engines, the consumption varying from $1\frac{1}{2}$ to $2\frac{1}{4}$ lbs. of coal per indicated horse-power per hour. In torpedo-boats with water-tube boilers and feed-heaters, M. Normand claims to have obtained even greater economy in coal consumption.

With some forms of artificial draught there appears to be a positive economy in the rate of coal consumption as compared with natural draught. This is possible if the natural draught conditions did not give an ample supply of air for combustion of the fuel. In general, however, with forced draught the rate of coal consumption tends to rise somewhat as compared with good natural-draught performance. Moderate forcing is, as a rule, practised in merchant ships, and with this there is no loss of economy. In war-ships, with closed stoke-holds at the higher air pressures, the rate of coal consumption increases somewhat. Such pressures are intended to be used only for short periods in cases of emergency, when the attainment of the highest speeds is of paramount importance. Under these circumstances economy in coal consumption is necessarily subordinated to the development of greater horse-power.

No discussion can be attempted here of the possible use of liquid fuel in ships, or of the applications which the system has already received. Its advocates assert that for a given weight of liquid fuel carried by a ship, a much greater weight of steam can be produced than by an equal weight of coal. Hence it would be possible either to increase the distance which a ship could steam, or to diminish the weight of fuel required to cover any assigned distance. High authorities estimate that 10 lbs. of petroleum refuse may be considered equal to 14 or 16 lbs. of good coal, when proper arrangements are made for burning the liquid fuel. Incidental advantages obtained with liquid fuel are complete control of the supply of fuel to the boilers by mechanical arrangements easily manipulated by a few men; the practical abolition of the laborious work of stoking and coal-trimming, and more perfect combustion. Hitherto the use of liquid fuel has been comparatively limited. In the mercantile

marine this has been due mainly to commercial considerations. In war-ships partly to considerations of defence, and to the results of experiments. The difficulty of obtaining supplies of liquid fuel in many parts of the world, the comparatively limited sources of supply and total supply available, have also had great weight. Some foreign navies are employing liquid fuel for torpedo-boats, and in large vessels are using it to supplement and assist the combustion of coal in the furnaces. This subject has received, and is receiving, considerable attention both in this country and abroad.*

Examples of the Influence of Engine Design upon Ship Design.— Illustrations might be multiplied of the effect which improvements in marine engines and boilers have had upon steamship design. Space is available for only a few striking cases.

In the Royal Navy during the period 1888–93, several of the older armoured ships have been fitted with new engines and boilers. The outlay has been considerable, but the resulting advantages are great. Take, for example, the *Thunderer*, designed in 1869, and fitted with box tubular boilers with 30 lbs. pressure, surface condensers, and horizontal engines. The total weight of propelling machinery and boilers was about 1050 tons. On the measured-mile trial 6270 H.P. were developed during six consecutive runs, the corresponding speed being 13·4 knots for the period of the trial, which probably did not exceed two hours at full power. With a total coal stowage of 1350 tons the ship could cover about 4500 knots at 10 knots. The total weight of machinery and coals was about 2400 tons. New triple-expansion engines, of the inverted cylinder type, and cylindrical boilers, carrying 145 lbs. per square inch, were fitted in 1889–90. The total weight of the new propelling apparatus was under 800 tons, and on trial with natural draught 5500 H.P. were developed on a continuous trial of 8 hours, while 7000 H.P. were developed for 4 hours with very moderate forced draught. Under the latter condition the speed was over 14 knots; with natural draught it was about 13½ knots. The superior economy of the new arrangements has enabled the same distance to be covered as before, with about 950 tons of coal instead of 1350 tons. The total weight of machinery and coals for this distance has, therefore, been reduced to less than 1750 tons, as against 2400 tons originally; and 650 tons disposable weight have been secured, which can be devoted to other purposes. At full speed the relative economy in coal consumption is greater with the new engines than it is at

* An admirable summary of facts bearing on this subject has been made by Colonel Soliani of the Royal Italian

Navy, and embodied in a paper for the Engineering Congress at Chicago, 1893.

cruising speeds, such as 10 knots. An actual trial has been made with the ship from Spithead to Madeira and back. The average indicated horse-power was about 4500 H.P., or over 80 per cent. of the specified natural-draught power; the mean speed was 13 knots, and the coal burnt per indicated horse-power per hour was $1\frac{2}{3}$ lb., probably about *one-half* that which the old machinery would have expended at the same speed. It is improbable that with the old machinery and boilers such a development of power could possibly have been obtained on a voyage of 2600 knots, and if it could have been realized, instead of burning 675 tons of coal for propulsion, about 1350 tons would have been expended. Facts such as these, and the economy in expenditure on coal which has been secured during the remaining period of service of this ship, justify the large expenditure incurred in the refit.

For ocean steaming at high speeds over long distances economy in coal consumption is the determining factor in commercial vessels, and the longer the voyage the greater are the gains of the modern type of machinery. As an example, take a passenger-steamer trading to Australia, and averaging at sea about 16 knots, with 6000 H.P. With compound engines such as were in use in 1881, the daily consumption of coal for propulsion would have been about 125 tons per day, or from 3700 to 3800 tons for the voyage. With triple-expansion engines such as are now fitted, the daily consumption would be about 100 tons, or from 3100 to 3200 tons for the voyage. A saving of 600 tons on the coal burnt does not, of course, measure the gain, because what is saved in weight of coal carried can be made available for freight-earning. If desired, the economy in coal consumption can be utilized in adding to the size and speed in new steamers, while keeping practically to the same expenditure of coal. On the Atlantic service this has been done, and by the adoption of triple-expansion and higher steam pressures, vessels of greater size and engine power have been produced, which steam a knot faster and yet burn no more coal than their predecessors of smaller size do with compound engines at a lower speed.

As an example of the possible influence of liquid fuel, the case may be taken of an Atlantic steamer averaging 20 knots, and burning about 1900 tons of coal on the voyage. Accepting the relative values of coal and liquid fuel above stated, about 1300 tons of petroleum refuse should be equivalent to the 1900 tons of coal, and 600 tons of disposable weight would be obtained. This might be added to the weight of cargo if desired, and would constitute a very substantial addition thereto. Or it might be distributed partly in additional boilers and engine power, and partly in fuel, enabling a higher speed to be realized in a ship of the same form and

dimensions. Or it would enable a ship of less size to be produced, having the desired qualities of speed and carrying power.

In cargo-steamers, no less importance attaches to the types of engines and boilers employed, economy in working being essential to successful competition. The horse-power developed in the ordinary type of cargo-carrier working at a speed of 9 to 10 knots is very moderate, and the expenditure of coal is small; but the aggregate gain—including reduction in coal carried and burnt, and the corresponding increase in cargo—has led to the rapid introduction of triple-expansion engines in the place of compound.* To illustrate this, take a vessel of 5000 tons displacement averaging $9\frac{1}{2}$ knots at sea, and indicating about 1000 to 1100 H.P. With compound engines of the type used in 1881, the hourly consumption would be about 17 cwt., and the daily consumption about $20\frac{1}{2}$ tons. With triple-expansion engines of recent types, the same speed could be obtained with a daily consumption of about 16 to 17 tons. A voyage of 3000 knots would occupy about 13 days; with compound engines about 265 tons of coal would be burnt, and with triple-expansion engines about 215 tons. The total dead-weight carrying capacity would be about 3400 tons; with compound engines, the cargo would therefore weigh about 3140 tons, and with triple-expansion engines, about 3190 tons. It has been estimated by ship-owners that each ton added to freight may be regarded as equivalent to from £6 to £7 per annum. So that in freight-earning the saving of 50 tons on coal carried would represent from £300 to £350 per annum, besides the saving on the coal. The latter saving requires further assumption to be made of the total time per annum the steamer is running, and the price of coal. Supposing the vessel to be running 240 days in the year, the total saving would be about 950 tons of coal, and if £1 per ton is taken as the average price paid for coal at home and abroad, this saving will represent £950. Adding the freight value, the total annual economy is from £1200 to £1300. These figures are put forward as illustrations only, and must not be treated as exact measures of the economy which might be realized.

This case also represents the remarkable economy of a modern cargo-steamer. Each ton of coal burnt suffices to drive 5000 tons' weight of ship and cargo about $13\frac{1}{2}$ knots. An average expenditure of £1 on coal, therefore, transports 3000 tons of cargo over the distance named. There are, of course, other working expenses to be considered, besides the charges on capital account and depreciation, but into any estimate of these it is not proposed to enter.

* See a valuable paper bearing on this subject by Mr. Hall, in vol. iii. of the *Transactions* of the North-East Coast

Institution of Engineers and Ship-builders; also a paper by Mr. Boyd, in vol. vi. of the same *Transactions*.

The last illustration may be taken from cross-channel steamers. A certain class still in actual service were fitted with low-pressure boilers and simple-expansion engines applied to paddle-wheels. The indicated horse-power on trial was 2800 H.P., and the measured-mile speed $18\frac{1}{2}$ knots. The total weight of machinery and boilers was 320 tons. If it were possible to substitute screws for paddles on this service, using the torpedo-vessel type of machinery and locomotive or water-tube boilers, with forced draught, the same power could be obtained for a total weight of about 140 tons, or less than one-half the actual weight. Here there would be a large saving on the quick-running engines and screws as compared with slow-running engines and paddle-wheels. Moreover, limitations of draught or considerations of steadiness might lead to the adoption of paddle-wheels even if locomotive or water-tube boilers and high pressures of steam were employed. With special forms of screw-propellers, however, a very limited draught could be accepted without undue sacrifice of efficiency.

CHAPTER XV.

MARINE PROPELLERS.—FUNDAMENTAL PRINCIPLES OF ACTION :
WATER-JETS AND PADDLE-WHEELS.

THE selection of the type of engine for a new steamship is closely associated with the choice of a suitable propeller. In some cases the character of the service for which a ship is designed virtually decides the choice of a propeller, and the type of engine is governed by the consideration of the efficiency of the propeller. The paddle-wheel has been in use from the earliest days of steam propulsion, and still continues to be employed for ships of shallow draught, chiefly in smooth-water service. Experimental screw-propellers were also used at a very early period, but it was not until 1836 that this class of propeller began to be applied to ships in a practical manner, and the *Archimedes*, the first seagoing steamer, was launched in 1838. At the present time, for seagoing service screw-propellers are universally employed; and for channel or coasting service, screws have taken the place of paddle-wheels to a large extent. Special forms of screw-propellers are now used even in vessels of very shallow draught, wherein until recently paddle-wheels were exclusively employed.

The chief practical difficulty with paddle-wheels, applied in large seagoing steamers, arose from the variations in performance produced by changes in the draught of water and the immersion of the floats, as well as from the influence of rolling motion upon the efficiency. In performing long voyages, the consumption of coals and stores produced a considerable lightening of the draught, and decrease in the immersion of the paddle-floats. That fact necessarily involved a diminished efficiency at some portions of the voyage. Paddle-floats which at starting were too deeply immersed, might be insufficiently immersed at the end. By means of water ballast this difficulty could be overcome, of course, at the cost of an increased mean draught and larger expenditure of engine power; but the plan has not found favour, because in other respects the screw-propeller is so superior to the paddle-wheel. Rolling motions involve alternate deep submergence and emergence of paddle-wheels placed outside the main

breadths of ships. In the one case the revolutions are retarded, in the other greatly accelerated; and these alternations involve serious straining actions as well as losses in propelling effect. With screw-propellers pitching at sea may cause racing and loss of efficiency, and with twin-screws of large size in relation to draught, rolling may cause some variations in efficiency; but in no case are the losses so serious as with paddles. The considerable increase in breadth necessary with paddle-wheels, is a further argument against their use in large ships. By common consent the paddle-wheel is now used only under conditions where the voyages are short and mostly in smooth water. The variations in draught are then trifling, and fairly uniform efficiency is maintained. Under these circumstances the paddle-wheel as a propeller does not compare unfavourably with the screw. Its use, however, involves the employment of a slower-moving and heavier type of engine. While the paddle-wheel has thus been subordinated to the screw-propeller, it must not be overlooked that for a long period the swiftest steamships were driven by paddles, and that some of the latest and swiftest Channel steamers are similarly propelled. Her Majesty's yacht *Victoria and Albert*, built in 1854-55, attained a speed of 17 knots, which was then most remarkable; the Holyhead packets of 1860 attained 18 knots; the Viceroy of Egypt's yacht *Mahroussé*, built in this country in 1865, reached the same speed; and recent Channel steamers have attained 21 to 22 knots.

The water-jet or hydraulic propeller cannot be regarded as a serious competitor with the screw or paddle-wheel, but it has attracted so much attention and been so strongly recommended that it cannot be left unnoticed. This form of propeller was made the subject of a patent in 1661. Mr. Ruthven has the credit of bringing it into practical use in 1839, when he constructed two boats for experimental purposes. Other vessels were built between this date and 1866 with hydraulic propellers, including a floating fire-engine and the *Nautilus*, a river steamer 115 feet long. The Admiralty then authorized the application of the system to the armoured gunboat *Waterwitch*, 162 feet long and of 1160 tons displacement, in order that it might be tried in competition with twin-screws fitted to similar vessels. This is the largest experiment with the hydraulic propeller yet made, and the results were not sufficiently satisfactory to induce any extended use of the system in war-ships. Since 1866 further trials have been made on small vessels in Sweden, Germany, and this country. The latest vessel so propelled is a steam lifeboat built for the National Lifeboat Institution by Messrs. Green, with machinery by Messrs. Thornycroft. In that instance the hydraulic system was adopted because it was thought more suitable than the screw for service in rough water, where the screw might race greatly, and in shallows

where an ordinary screw might be fouled. A greater expenditure of power was accepted in order to secure these contingent advantages.

In the great majority of screw steamers there is a single screw, placed in an aperture between the body of the ship and the stern-post to which the rudder is hung. In a few cases the single screw has been placed abaft the rudder, which has been suitably formed to be worked either under the shafting, or in two parts, one above and one below the shafting. By moving the screw further aft from the stern of the ship, it was anticipated that economy in propulsion would be increased. This change in position undoubtedly decreased the augmentation of resistance due to the screw action. On the other hand, the screw was not so well placed to utilize the energy in the frictional wake, and the net result on propulsion did not give the gain anticipated. In addition, there were practical difficulties in the arrangement. The screw was more exposed to accidental injury; the steerage was not so good, especially when gathering way; and the movement of the rudder affected the flow of water to the propeller. After a considerable trial, therefore, the system was abandoned.

There have been many proposals to place single screws much further forward than the usual position, either in tunnel-shaped cavities formed in the vessel or directly underneath her. An interesting experiment of this kind was made by Messrs. Herreshoff in a torpedo-boat purchased by the Admiralty. The screw was placed under the boat at a considerable distance before the stern. The results were fairly satisfactory, but there was no good basis for comparison of efficiency with the ordinary plan. Mr. Yarrow made a trial on similar lines in a torpedo-boat of larger size. In that case the results obtained with a screw working below the boat were very inferior (measured by the speed obtained with a given indicated horse-power) to results with a screw in the ordinary position. General experience confirms the opinion that this position gives the best results for steerage and propulsion. For efficiency the stern must be formed suitably to permit the free flow of water to the propeller, and care must be taken to diminish the resistances of stern-posts and rudder-posts, especially in wood or composite vessels. Experiments have shown that with very thick stern-posts and rudder-posts, the augmentation of resistance may be practically doubled, as compared with what would happen if these appendages were of small thickness and suitably shaped.

Twin-screws, one placed under each counter, were tried at a very early period. Their use was practically limited to vessels of shallow draught or relatively high speed until 1865-70. For blockade-running during the American Civil War, for special services in shallow water, and in certain coast-defence vessels, twin-screws were used.

An experimental armoured twin-screw vessel, the *Penelope*, was built for the Royal Navy in 1866-67. Soon after, twin-screws were adopted for the *Audacious* class, and in the ill-fated *Captain*. The general use of twin screws in seagoing war-ships of deep draught dates from 1869, when the so-called "mastless" type of moderate freeboard turret-ship (*Devastation* class) was introduced. Since that date twin-screws have been gradually growing in favour in the Royal Navy, and at present single screws are fitted only to sloops or gunboats having good sail power, or to torpedo-boats. Most of the larger classes of torpedo-boats, or "destroyers," have twin-screws. Foreign fleets have adopted a similar practice.

In the mercantile marine twin-screws have been much more recently adopted in seagoing ships of deep draught. Prior to 1889 few such ships were at work. Most of the largest and swiftest passenger-steamers since brought into service have had twin-screws; and the system is growing in favour. On the Atlantic service, with its very high speed and limited draughts of water at some of the principal ports of call, twin-screws have been found necessary to the utilization of the great engine power. It is, however, a notable fact that in many of the largest cargo-steamers recently built—in which only moderate engine powers have to be utilized, and the draught of water is ample for single screws—twin-screws have been preferred for other reasons. Many authorities maintain that, for vessels trading to the East, twin-screws are more liable to damage than single screws when passing through the Suez Canal. Some very important vessels now on that service already have twin-screws. As speeds are increased under the stress of competition, and larger powers have to be utilized on a draught practically fixed, it may be anticipated that, as on the Atlantic service, twin-screws will be more extensively used.

From the explanations given in Chapter XVI., it will be understood that by subdividing the power, having two sets of machinery and twin propellers, smaller diameters of screws can be employed than are possible with single screws. All the moving parts of the machinery can be made of less size and weight, and the straining forces due to reciprocating motion can be lessened. Shafting can be reduced in diameter, its manufacture facilitated, and the risk of fracture diminished. The duplication of machinery and propellers makes the risk of total disablement much less. A twin-screw ship, with one engine and propeller at work, and using the helm to keep her course, is perfectly under control, while she can make fair speed. Cases are on record, of quite recent occurrence, where twin-screw passenger-steamers have proceeded with one screw at speeds only two to three knots less than their full speed with both screws. Twin-screws also give greater handiness. In war-ships this has long been

recognized. In the mercantile marine it has been found of great advantage in "slewing" long ships in limited space, in entering docks, and under other circumstances where a single-screw ship would be almost helpless. Water-tight subdivision in the machinery compartments can also be secured by means of longitudinal bulkheads between duplicate engines, as explained on p. 33.

It was feared that twin-screws would be more liable to damage than single screws when ships were entering or leaving docks, going alongside wharves, or taking the ground. Precautions have been taken in some instances to reduce the projection of twin-screws, and bring the shafts closer to the middle line. In some vessels one screw is placed somewhat before the other, an aperture being formed in the deadwood, so that the screw discs may overlap. It appears, however, from experience with ships fitted in this manner working side by side with other ships with the twin-screws not overlapping, and consequently projecting further from the middle line, that freedom from accident is not much increased by overlapping. In fact, with reasonable precaution in management, the risks of injury to twin-screws in large ships do not seem great. With small ships of high speed, having relatively large screws, greater care must be taken. Duplication of machinery and propellers probably involves the occupation of somewhat more space, and a larger staff may be needed than with a single engine and screw. These disadvantages do not appear to be of any relative importance when set beside the gains obtained with twin-screws, even in cases where there is no necessity, on the score of propulsive efficiency, to use the latter, as in the large cargo-steamers of moderate speed above mentioned. There is an increasing use of twin-screws in other mercantile marines also. At the commencement of 1893 it is stated that there were in existence 112 twin-screw ships of over 1000 tons gross tonnage in all mercantile marines, and 35 twin-screw ships are reported to have been launched in this country during that year. This is a very small proportion of the total number of steamships, but in this number are included a very large proportion of the most recent and swiftest ocean-going steamers.

Formerly there was an impression that single screws were more efficient as propellers than twin-screws.* Enlarged experience has demonstrated that twin-screws are at least as efficient, and under many circumstances more efficient. This has been proved in all

* As a matter of historical interest, reference may be made to a paper contributed by the author to the *Transactions* of the Institution of Naval Archi-

tects for 1878. Interesting particulars of early experience with twin-screws in merchant steamers will be found in the same *Transactions* for 1864-66.

sizes and classes of war-ships, and more recently in mercantile experience. Some of the highest propulsive coefficients yet obtained have been reached in twin-screw ships (see p. 543). With a given draught the smaller diameter of twin-screws carries with it deeper immersion, and this tends to increased efficiency in smooth water, while at sea it diminishes the chance of racing when a ship is pitching. The smaller diameter and different position in relation to the stern of twin-screws tend to decrease the augmentation of resistance due to their action, as compared with single screws. On the other hand, they are not so favourably placed for utilizing the frictional wake. Care must be bestowed upon the arrangements and forms of the struts, tubes, etc., which are necessary when the shafts are carried outboard with twin-screws. If, as is now frequently done, the stern is "bossed" out to carry the propeller-shafts, equal care must be taken to obtain suitable forms for the after-terminations. When such care is taken, the broad fact is established that twin-screws, with all their attendant advantages above enumerated, do not involve lessened efficiency.

Twin-screws are not so well adapted as single screws to the use of sail power. Auxiliary sail power may be of service in economizing coal, even in twin-screw ships. It is possible sometimes, with a favourable wind, to use one screw in association with sail, or to run before the wind, using both sail and screws. For vessels of war, intended to make passages under sail alone, single screws are a practical necessity. In the mercantile marine, as twin-screws have been adopted, sail has practically disappeared. Increased dimensions in ships has reduced the propulsive value of even the full-sail equipments formerly carried, and the duplication of propelling apparatus has rendered sail of little importance as an auxiliary to steam power. In twin-screw war-ships, with few exceptions, only steadying fore-and-aft sail is now carried. Experience shows, moreover, that in nearly all cases, even at low cruising speeds, it is most economical to use both screws, rather than to work one screw, allow the other to revolve or drag, and use small helm to keep the course.

Another method of using two screws, adopted in the "cigar" ships built by Mr. Winans, and in certain tugs, has been to run the shaft throughout the length, and to have a screw at each end. This plan cannot conduce to efficiency, seeing that the forward screw derives no benefit from the frictional wake, and its action must seriously affect the stream-line motions proper to the rate of advance of the vessel. Possibly the primary object has been to gain power for rapidly reversing the course without turning. Some ferry-boats have been fitted with two continuous shafts, a screw being carried at each end of each shaft. Trials have also been made on a few vessels

with two screws placed at the stern, one abaft the other, and rotating in opposite directions. One screw is mounted on an annular shaft, which rotates round a solid shaft carrying the other screw. This is the arrangement adopted in locomotive torpedoes, to ensure straight running.

Multiple screws, carried by independent shafts and placed at the stern, have been adopted in certain vessels of shallow draught and considerable power. Some of the shallow-draught vessels built for service on the Mississippi during the American Civil War had four screws. The Russian circular ironclads have six screws. Such special cases can be better dealt with, however, in future, if the necessity arises, by using special forms of propellers adapted to the light draught.

Triple-screws have also been used in many instances, and have been recently adopted in several swift cruisers, and in some battle-ships built abroad. The Russian imperial yacht *Livadia*, built in this country in 1880, has three screws. A model of this remarkable vessel was tested by the late Dr. Tideman, in the experimental establishment at Amsterdam. The augmentation of resistance is said to have been 22 per cent. of the tow-rope strain. This is high as compared with twin-screw ships of good form, but may be accounted for partly by the peculiar form of the *Livadia*. Reference to her performances under steam is made in Chapter XVII. It will there be seen that the draught of water was very light; but in this case the diameter of the screws was not limited by the draught, the lower portion of their orbits being much below the keel. A very interesting series of trials with triple-screws was made in France during 1884-85, with a small vessel (about 33 feet long) built for the purpose from the designs of M. de Bussy.* This vessel was really a model of a battle-ship about 340 feet long and of 9600 tons displacement. The form of the stern was arranged with special reference to the use of three screws, and differed considerably from ordinary practice. Possibly this fact somewhat affected the results when two screws only were used. Experiments were made with the three screws placed in one athwartship plane, as compared with two screws similarly placed. The latter had somewhat the advantage. The two outlying screws were then placed some distance ahead of the central screw, and a considerable improvement was found to result. In fact, the broad conclusion reached by the experimentalists was that in this vessel, when the best

* For details, see M. Marchal's paper in the *Transactions* of the Institution of Naval Architects for 1886. For par-

ticulars of the Italian trials with triple-screws, see a paper by Mr. F. C. Marshall, in the same *Transactions* for 1888.

arrangements for both triple and twin screws had been made, with equal disc-areas (*i.e.* with larger diameters in the twin-screws), equal efficiency was obtained.

Triple-screws were also tried about 1886–87 by the Italian naval authorities on torpedo gunboats of the *Tripoli* class. From the details which have been published, it appears that the utilization of power by the three screws was fairly satisfactory. On the other hand, it must be noted that in later vessels of the class, twin-screws have been preferred to triple.

It is reasonable to suppose that, as higher speeds are attained and larger powers have to be utilized, since the limits of draught for ocean-going steamers are fixed by practical considerations, triple-screws may become necessary to efficiency. At the present time (1893) a number of swift cruisers and some battle-ships belonging to foreign navies are being constructed with triple-screws, not because the draught is inadequate for twin-screws, but because the arrangement is preferred on other grounds. With triple-screws smaller diameters suffice. The subdivision of power into three sets of machinery instead of two, in association with the smaller screws, makes it possible to employ quicker-running engines of less height and stroke than with twin-screws. Such engines can be kept lower in the vessels, and therefore more readily installed under protective decks fitted at or near the water-line. Further, it is hoped—and this is probably one of the chief reasons for the change from twin-screws—that at low cruising speeds greater economy in coal consumption will be realized than is possible with twin-screws. The intention, under these circumstances, is to work only the central engines, to disconnect outlying screws, and allow them to revolve freely. In this way the waste work on the two idle sets of machinery would be avoided, and it has been shown (see p. 545) that at low powers this amounts to a considerable percentage of the total work done. On the other hand, the work done in making the idle screws revolve, or dragging them through the water, would be incurred. Experience will decide where the balance of advantage lies. Lastly, it is anticipated that, by placing a central screw immediately before a rudder, steerage will be sensibly improved.

This matter has been most carefully studied in connection with the design of ships of the Royal Navy, from a period antecedent to any of the experiments above mentioned. Up to the present time it has been considered that, with the speeds and powers required, the balance of advantage is with twin as compared with triple screws. The utilization of over 21,000 H.P. on H.M.S. *Blenheim* on twin-screws, within comparatively moderate limits of draught, has been remarkably efficient. Much greater power (said to attain 30,000 H.P.)

has been associated with great efficiency on accepted limits of draught in the latest twin-screw steamers belonging to the Cunard Line. Until actual experience has been gained on the triple-screw ships, it is not possible to say whether equal efficiency will be obtained. The French experiments on the model vessel do not settle this point, for reasons above stated. The Italian experience seems adverse. It is certain that there is a danger of decreasing efficiency by the mutual interference of triple-screws. The matter will no doubt be dealt with satisfactorily on the basis of experience, and it is now being investigated experimentally. Much light will be thrown upon these problems by the performances of the triple-screw ships now approaching completion in France, Germany, and the United States. It will be of great interest to ascertain if the anticipated economies at low cruising speeds will be realized. Careful trials, made in twin-screw ships of all classes, have proved it to be advantageous, as a rule, to use both engines and screws, even at very low powers, rather than to stop one engine and drag the corresponding screw. In that case some small angle of helm must be used to keep a straight course, and this tells against economy. But when ample allowance has been made for the drag of the rudder, greater economy is still found to result from using both engines. With two idle screws the case will be less favourable than with one. It may be added that marine engineers are fully alive to the importance of economy in cruising speeds, and plans are under consideration which aim at increasing economy by modifications in engine design, while retaining twin-screws.

For war-ships, with their necessities for convenient stowage of magazines, shell-rooms, etc., in relation to the disposition of the armament, the use of three sets of machinery and triple-screws involves many disadvantages. Were important gains to be certainly realized in propulsion, these other considerations would have to give way, and the best arrangements possible in association with triple-screws accepted. Up to the present time, however, there is no evidence that this step need be taken, or fighting efficiency diminished, in order to obtain more economical propulsion. In their manœuvring power, twin-screw ships of good form have proved entirely satisfactory. This is dealt with at some length in Chapter XVIII.

The screw-turbine propeller devised by Mr. Thornycroft has hitherto been used almost exclusively in vessels of light draught and moderate dimensions. It has features, however, which make it possible that, as speeds are increased, and greater powers have to be developed on limited draughts of water, this form of propeller may be more extensively used. A brief description of its principal

arrangements will be given.* The screw used is of very small diameter and coarse pitch; the blades are carried by a special form of boss, and there is a gradual increase in their pitch. A cylindrical casing surrounds the screw-blades. At the forward end of the casing the opening between the casing and the boss is of considerable cross-sectional area; this is gradually contracted by the enlargement of the boss, the varying area of the channel being adjusted to suit the gradual acceleration impressed upon the water by the action of the screw-blades, in order that losses of efficiency incidental to sudden changes of motion may be avoided. Aft the revolving blades, and attached to the casing and the after part of the boss, which is also fixed, are numerous fixed "guide-blades" of contrary flexure to the screw-blades. The coarse pitch of the revolving blades causes the water to be delivered from them with considerable rotary and sternward motion. The guide-blades direct this water into a sternward stream, and in doing so sustain a forward reaction which is a virtual increase of thrust available for propulsion. It is stated that this increase, when measured in a model experiment, amounted to one-third of the total thrust, and that the efficiency realized was equal to that of a common screw. The last claim was practically established by a trial made in a torpedo-boat of the Royal Navy. Originally she was fitted with an ordinary screw 5 feet 10 inches in diameter. This was removed, and a screw-turbine 3 feet in diameter substituted. The engines and boiler remained unaltered, and equally good results were obtained on trial as with the original propeller. One drawback must be mentioned; the screw-turbine, from the nature of the case, cannot be efficient when going astern, all its details being devised to give efficiency when moving ahead. Proposals have been made for meeting this objection to some extent, but it is understood they are only in the experimental stage. In extremely shallow-draught vessels, with the screw-turbine fitted in suitably shaped tunnels, of which the tops rise above still-water level, very good results have been obtained. Quick-running engines can be adopted with this propeller, and weight saved on the propelling apparatus.

FUNDAMENTAL PRINCIPLES OF THE ACTION OF PROPELLERS.

Before considering the actual and relative efficiencies of the three classes of propellers which have been used in steamships, it is proposed to sketch briefly the fundamental principles governing the action of

* For fuller details, see papers by 1883-85. Also Mr. S. Barnaby's "Marine
Mr. Thornycroft in the *Transactions* of Propellers."
the Institution of Naval Architects for

all propellers.* When a ship has acquired uniform motion, the thrust of the propeller is equal and opposite to the resistance of the water to her motion. Both thrust and resistance may be considered to be forces acting parallel to the keel of the ship. The thrust of the propeller is measured by the *sternward momentum* communicated in each unit of time to the column of water on which it acts. Some propellers communicate other than sternward motion to the water they act upon, but only the sternward momentum can be reckoned into the thrust.

As the simplest case, take first a direct-acting propeller communicating only sternward motion to the water.

Let C = the cubic feet of water acted upon by the propeller per second.

w = the weight in pounds of each cubic foot of water.

v = the sternward velocity (in feet per second) relatively to still water impressed upon the column of water (C) by the action of the propeller; v measures the "true slip" of the propeller.

V = the speed of advance of the ship relatively to still water, and of the propeller carried in the ship.

V_1 = the sternward speed of the column relatively to the propeller at the point of passage through the propeller.

R = reaction of the column, corresponding to the acceleration v .

Then, in accordance with principles previously explained—

$$\frac{\text{Reaction (R)}}{\text{Weight of water acted upon per second}} = \frac{v}{g}$$

where g is the acceleration corresponding to the force of gravity, or 32.2 feet per second. Hence—

* The following authorities may be consulted by readers desirous of following out the theoretical investigations on this subject: Papers by the late Professor Rankine in the *Transactions of the Institution of Naval Architects* for 1865, and in his "Miscellaneous Scientific Papers"; by the late Mr. Froude in the same *Transactions* for 1865 and 1878; by Mr. R. E. Froude in the same *Transactions* for 1883, 1886, 1889, and 1892; by Professor Cotterill in the *Annual of the Royal School of Naval Architecture*,

Nos. 2 and 3, and in the *Transactions of the Institution of Naval Architects* for 1879 and 1887; by Professor Greenhill in the same *Transactions* for 1888; by the late Sir Francis Knowles in the *Proceedings of the Institution of Civil Engineers* for 1871; by Professor Fitzgerald in the *Proceedings of the Belfast Philosophical Society* for 1890; and by M.M. Pollard, Dudebout, and Drzewiecki in the *Bulletin de l'Association Technique Maritime* for 1892.

$$\begin{aligned}
 R \text{ (in pounds)} &= \frac{v}{g} \times \text{weight of water acted upon per second} \\
 &= \frac{v}{g} \times C \cdot w \quad \dots \quad (1)
 \end{aligned}$$

For sea-water $w = 64$ lbs.; so that—

$$R = \frac{v}{32.2} \times C \times 64 = 2C \cdot v \text{ (nearly).}$$

The “total work” expended in giving the sternward momentum to the water acted upon, is expressed by the change in *vis viva* involved in passing from the speed V to the speed $V + v$.

In symbols—

$$\begin{aligned}
 \text{Total work} = W \text{ (foot-pounds)} &= \frac{C \cdot w}{2g} \{(V + v)^2 - V^2\} \\
 &= \frac{C \cdot wv}{2g} (2V + v) \quad \dots \quad (2) \\
 &= R \cdot \left(V + \frac{v}{2}\right)
 \end{aligned}$$

The “useful work” of propulsion is measured by the product of the reaction R into the distance V per second. Or—

$$\text{Useful work} = R \cdot V \quad \dots \quad (3)$$

The excess of the “total” above the “useful” work measures the “waste” work. Hence—

$$\text{Waste work} = R \left(V + \frac{v}{2}\right) - R \cdot V = R \cdot \frac{v}{2}$$

Also—

$$\text{Efficiency} = \frac{\text{useful work}}{\text{total work}} = \frac{R \cdot V}{R \left(V + \frac{v}{2}\right)} = \frac{2V}{2V + v}$$

The “total work” expended may also be expressed in the form—

$$\text{Total work} = R \cdot V_1 \quad \dots \quad (4)$$

Equating the values for the same quantity given in (2) and (4)—

$$\begin{aligned}
 R \cdot V_1 &= R \cdot \left(V + \frac{v}{2}\right) \\
 V_1 - V &= \frac{v}{2} \quad \dots \quad (5)
 \end{aligned}$$

Hence it appears that, under these assumed conditions, the propeller may be regarded as producing half the acceleration (v) before the water reaches the propeller, and the remaining half when the water is passing through the propeller. This analysis is due to Mr. R. E. Froude, the ordinary assumption having been that the whole

acceleration was produced with comparative suddenness at the propeller. In practice, no doubt, other conditions tend to modify the theoretical result indicated by Equation (5); but it has great interest, and the fact that a certain part of the acceleration is produced before water passes through a propeller tends to increase efficiency. So far as the thrust (R) is concerned, it will be obvious, from Equation (1), that so long as the final acceleration reaches v the thrust remains unaltered. From that equation it will be seen also that, so long as the product $C \cdot v$ remains constant, the thrust remains constant. On the other hand, if C is diminished, and v correspondingly increased to maintain the constant thrust, then the waste work is increased, and the efficiency diminished. Consequently for a given thrust, so far as these mathematical expressions are a guide, it is advantageous to increase the quantity of water (C) acted upon, and to diminish the sternward acceleration v . In practice, as will be shown hereafter, this broad conclusion requires modification. In dealing with large quantities of water, a serious increase may arise in the waste work on propelling apparatus. Thus it may happen that the desire to obtain the best combined efficiency of propulsion puts a limit upon the quantity of water acted upon. Again, with special forms of propellers and arrangements for utilizing the momentum of the "race" delivered by the propellers, good efficiency may be obtained with considerable sternward acceleration.

As a second case, take a propeller which is set obliquely to the keel line, and communicates transverse as well as sternward motion to the water.*

Let T = the transverse component of the reaction.

R = the longitudinal " " "

v_1 = the transverse component of the acceleration.

v_2 = the longitudinal " " "

Then—

$$\sqrt{v_1^2 + v_2^2} = \text{the oblique acceleration} \quad . \quad . \quad (6)$$

Then, according to the results obtained in the first case—

$$R = \frac{C \cdot w}{g} \cdot v_2 \quad . \quad . \quad . \quad . \quad (7)$$

$$T = \frac{C \cdot w}{g} \cdot v_1 \quad . \quad . \quad . \quad . \quad (8)$$

$$\text{Oblique reaction} = \sqrt{R^2 + T^2} = \frac{C \cdot w}{g} \cdot \sqrt{v_1^2 + v_2^2}.$$

Also after the water has passed through the propeller it has the

* This and the following case are reproduced from Mr. R. E. Froude's paper in the *Transactions* of the Institution of Naval Architects for 1892.

longitudinal speed $V + v_2$, and the transverse speed v_1 . Compounding these velocities—

$$\left. \begin{array}{l} \text{Oblique velocity after passing} \\ \text{through the propeller.} \end{array} \right\} = \sqrt{(V + v_2)^2 + v_1^2} \quad . \quad . \quad . \quad (9)$$

$$\left. \begin{array}{l} \text{Velocity before being acted} \\ \text{upon by the propeller} \end{array} \right\} = V \quad . \quad . \quad . \quad . \quad (10)$$

$$\begin{aligned} \text{Total work} &= \frac{Cw}{2g} \{(V + v_2)^2 + v_1^2 - V^2\} \\ &= \frac{Cw}{g} v_2 \left(V + \frac{v_2}{2}\right) + \frac{Cw}{g} v_1 \cdot \frac{v_1}{2} \\ &= R \left(V + \frac{v_2}{2}\right) + T \cdot \frac{v_1}{2} \quad . \quad . \quad . \quad (11) \end{aligned}$$

As a third case, take a propeller which produces rotary as well as sternward acceleration in the water acted upon; for example, a strip or annulus on a screw-propeller blade situated at a radial distance d from the axis about which it turns. The annulus is supposed to be very narrow measured radially from the axis, but to have the full breadth of the propeller blade.

Let v = the sternward component of acceleration imparted.

α = the angular component " " "

R = the longitudinal component of reaction.

M = the rotary component of reaction expressed as a moment about the axis.

Here the linear motion in a transverse plane is $d \cdot \alpha$, corresponding to v_1 in the preceding case; also $M = T \cdot d$. Making these substitutions in Equations (7), (8), and (11)—

$$R = \frac{Cw}{g} \cdot v \quad . \quad . \quad . \quad . \quad . \quad (12)$$

$$M = \frac{Cw}{g} \cdot d^2 \cdot \alpha \quad . \quad . \quad . \quad . \quad . \quad (13)$$

$$\text{Total work} = R \left(V + \frac{v}{2}\right) + M \cdot \frac{\alpha}{2} \quad . \quad . \quad . \quad . \quad (14)$$

The three cases of direct-acting, oblique, and spiral propellers, above considered, have been dealt with under certain hypothetical conditions, which hold good for elementary propellers of small area, but which are known not to apply absolutely to actual propellers. For instance, paddle-wheels in practice have floats of large area spaced at certain distances apart; these act more or less obliquely on the water, waste work in various ways, and cause changes of level and pressure in the race as well as changes of velocity. Screw propellers also cannot be considered simply as an aggregation of annular elements such as that considered in the third case. For

such an annular element, it may be supposed that the acceleration or spiral speed, impressed on the water forms a hollow cylindrical column of water which has practically the same pressure as the undisturbed water surrounding it. When a screw acts on the whole column of water which forms its race, this condition does not hold good, and there is a change of pressure as well as of velocity to be considered. Moreover, in the hypothetical cases no attempt has been made to define the manner in which the acceleration is produced, nor to evaluate the waste work which in practice has to be done in overcoming frictional and other resistances to the motion of the propellers through the water. This waste work is tantamount to a decrease in thrust, or to an increase in the total work to be done in obtaining a certain thrust, and therefore to a decrease in efficiency.

Another difference to be noted between the hypothetical cases and the conditions of practice is that the equations framed for the former assume that the propellers act upon water which is undisturbed except by the action of the propellers. In practice, propellers have to act upon water which has impressed upon it independent stream-line motions, due to the advance of the ship, and upon frictional wakes of the character previously described. The action of the propellers is necessarily affected by this circumstance, and the point will receive further illustration when dealing with paddle-wheels and screws. Speaking broadly, all conditions which affect the flow of water relatively to propellers must also influence their efficiency. Amongst these conditions may be mentioned the kind of propeller used, its dimensions, its position in relation to the hull, and its immersion. The forms of ships, especially in the neighbourhood of the propellers and the degree of roughness of their bottoms, are also important factors in determining efficiency.

THE WATER-JET PROPELLER.

This form of propeller is exceedingly simple in its action. Water is permitted to enter the ship through inlets in the sides or bottom. The motion of the ship is necessarily impressed upon the water which enters. It then passes, in most cases, into a turbine or centrifugal pump driven by the main engines, and is expelled with considerable velocity through passages leading to an outlet or nozzle placed on each side of the ship. The reaction of the streams issuing from the nozzles constitutes the propelling force; and this remains practically constant, whether the nozzles are above or under water, so long as the velocity of outflow and the speed of the ship remain the same. If the nozzles are

placed below water, their projection beyond the sides of the ship causes additional resistance. If they are placed above water, the turbine has to do some additional work in raising the issuing jets to this higher level. Experience shows, however, that the balance of advantage is obtained by placing the nozzles a little above the water-line. In most cases arrangements have been made by which, while the engines and turbines continue to run in one direction, the issuing streams can be diverted, at the will of the commanding officer, from the sternward direction of outflow to the reverse. By this means the movement of a vessel can be rapidly checked or reversed. By making one jet deliver ahead, and the other astern, the vessel can be turned within a very small space, practically on the centre of her length.

In order to secure the greatest efficiency with this form of propeller, the following points require to be carefully considered: First, the arrangement of inlets, so that the water on entering may be given the motion of the ship gradually and without shock, and the minimum of waste work done in giving motion to water which does not enter the ship. Second, the arrangements of the passages by which the water is conducted to the turbine, and from the turbine to the outlets, so as to minimize the resistances and waste work due to friction, sharp bends in pipes, etc. Third, the quantity of water employed, and the character of the turbine. As explained above, this quantity of water involves the consideration of the velocity of outflow and the sectional area of inlets, passages, and outlets. Fourth, the design of the engine which drives the turbine. The total efficiency of the propelling apparatus depends, therefore, upon the individual efficiencies of the engines, the turbine (including the inflow and delivery of water), and the jets.*

Using the same notation as on p. 583, let A = the joint area of the outlets in square feet. Then—

$$\begin{aligned} \left. \begin{array}{l} \text{Cubic feet of water (C) delivered per} \\ \text{second} \end{array} \right\} &= A \cdot V_1 \\ \left. \begin{array}{l} \text{Weight of seawater (W lbs.) delivered} \\ \text{per second (nearly)} \end{array} \right\} &= 64 \cdot A V_1 \\ \left. \begin{array}{l} \text{Sternward velocity of jets (v) in relation} \\ \text{to still water} \end{array} \right\} &= V_1 - V \end{aligned}$$

$$\text{Reaction (R lbs.) in seawater (nearly)} = 2 \cdot C v = 2 A V_1 (V_1 - V)$$

$$\text{Useful work of propulsion} = R \cdot V = 2 A V_1 (V_1 - V) \cdot V$$

$$\text{Energy in "race"} = C \cdot v^2 = A V_1 (V_1 - V)^2.$$

* See papers by Signor Brin in the *Transactions* of the Institution of Naval Architects for 1871; and by Mr. S.

Barnaby in the *Proceedings* of the Institution of Civil Engineers for 1884.

Neglecting waste work involved in the admission of water and its movements while being accelerated up to the velocity of discharge—

Total work of propulsion = useful work + energy in race

$$\begin{aligned} &= AV_1(V_1^2 - V^2) \\ \text{Efficiency of jet} &= \frac{\text{useful work}}{\text{total work}} = \frac{2AV_1(V_1 - V)V}{AV_1(V_1^2 - V^2)} \\ &= \frac{2V}{V_1 + V} \end{aligned}$$

This limiting efficiency is not attained in practice, and could only be reached supposing the inlets and passages were so arranged that the water entered the turbine at the speed V , and was gradually accelerated up to the speed V_1 . The total energy of the "feed-water" under these hypothetical conditions would be represented by the expression—

$$\text{Energy of feed-water} = A \cdot V_1 \cdot V^2$$

and in practice this energy is more or less lost. Supposing it to be entirely lost, then the total work done in propulsion becomes increased by the lost energy. In symbols—

$$\begin{aligned} \text{Total work} &= \text{useful work} + \text{energy in race} + \text{energy of feed} \\ &= 2AV_1 \cdot (V_1 - V)V + AV_1(V_1 - V)^2 + AV_1 \cdot V^2 \\ &= AV_1(2VV_1 - 2V^2 + V_1^2 - 2VV_1 + V^2 + V^2) \\ &= A \cdot V_1^3. \\ \text{Efficiency of jet} &= \frac{\text{useful work}}{\text{total work}} = \frac{2AV_1(V_1 - V)V}{AV_1^3} \\ &= \frac{2(V_1 - V)V}{V_1^2} = \frac{2v \cdot V}{V_1^2} \end{aligned}$$

The extent to which the energy of feed is lost varies with the character of the inlets and of the passages leading to the turbine, as well as the design of the turbine. In cases where it is desired to preserve the power of steaming equally well ahead or astern, the whole energy of feed is practically lost. If this quality is sacrificed, and motion ahead made as efficient as possible, then a considerable part of the energy of the feed can be utilized by suitably forming the inlets and passages. In the *Waterwitch* the inlets were placed under the bottom, nearly amidships, and the water passed almost vertically into the centrifugal pump, whence it was delivered through nozzles placed at the water-line. By simple arrangements the streams could be ejected either ahead or astern, without altering the motion of the engines and pump. The vessel was a "double-ender," so as to be capable of steaming equally well with either end foremost. The joint sectional areas of the nozzles amounted to $5\frac{1}{2}$ square feet. On her full-speed trial, at a displacement of 1160 tons, the ship attained

a speed of 9·3 knots with 760 H.P. The velocity of discharge (V_1) was 29 feet per second; the speed of ship (V) was 15·7 feet per second; the speed of discharge (v) relatively to still water was therefore 13·3 feet per second, and 154 $\frac{2}{3}$ cubic feet of water were discharged per second. In this case nearly the whole energy of feed-water was lost, and consequently by the preceding formula—

$$\text{Efficiency of jet} = \frac{2 \times 13\cdot3 \times 15\cdot7}{(29)^2} = 0\cdot5 \text{ (nearly).}$$

The total efficiency of the propelling apparatus is given by the expression—

$$\begin{aligned} \text{Total efficiency} &= \frac{\text{useful work}}{\text{I.H.P.} \times 550} = \frac{2 \times 154\frac{2}{3} \times 13\cdot3 \times 15\cdot7}{760 \times 550} \\ &= 0\cdot16 \text{ (nearly).} \end{aligned}$$

This final result expresses the losses resulting from waste work on the engines, and from waste work on the pump. It has been estimated that fully 23 per cent. of the indicated horse-power would be absorbed by frictional and other resistances in the engine, and that the efficiency of the pump would have been only about 40 per cent. of the power delivered to it; the net power represented by the jets being, therefore, only about 30 per cent. of the indicated horse-power.* If it be assumed that the jet propeller practically causes no considerable augment of resistance, then the expression for the total efficiency would correspond to the propulsive coefficients above described, and its value will be seen to be very low as compared with the propulsive coefficients of screw-steamers given on p. 542.

The *Waterwitch* was actually tried against two twin-screw vessels, the *Viper* and *Vixen*, of equal length and beam, and approximately the same displacement. These two vessels were similar in form to the *Waterwitch* in the fore body, but in the after part they were not nearly so well shaped. The twin-screws were carried by double dead-woods, with a tunnel-shaped cavity between them; and the resistances were thus increased to a considerable but unknown extent as compared with the *Waterwitch*, while the efficiency of the propellers was probably diminished as compared with that of ordinary twin-screws. Notwithstanding these disadvantages, the *Viper* attained a speed of 9·6 knots at a displacement of 1180 tons with 696 I.H.P., which was a sensibly better performance than that of the *Waterwitch*.

Experiments were made in the *Waterwitch* with reduced sectional areas of the nozzles. The results indicated a decreased efficiency, as

* See the detailed calculations for efficiency of *Waterwitch* and other vessels in Mr. Barnaby's paper above cited.

In that paper the sectional area of nozzles is taken at 6·28 square feet, instead of the 5 $\frac{1}{2}$ square feet used in the text.

might be expected from the formulæ given above. In order to maintain the thrust requisite to drive the ship at a given speed, if the sectional area of discharge (A) is diminished, the velocity of the discharge V , and the sternward speed of the jets relatively to still water, must be increased. On the other hand, increase in the sectional area of discharge enables the velocity of discharge and waste work in the race to be diminished. There are, of course, practical limits to increase in sectional area of discharge and the quantities of water dealt with, and what has to be sought for is that combination which will give the highest total efficiency for the whole propelling apparatus.

In 1878, twelve years after the trials of the *Waterwitch*, another very interesting comparative trial was made in Sweden on two torpedo-boats, 58 feet long, and of about 20 tons displacement, identical in form, with boilers of the same size and type. One of these boats was driven by twin-screws, the other by water jets delivered by two centrifugal pumps. The inlets were placed amidships under the bottom, and the outlet pipes were carried some distance forward and abaft of the pumps in order to avoid sharp bends. The jets could be discharged either towards the bow or the stern, and as first fitted it was intended to be able to steam equally well in either direction. Subsequently the inlets were altered in form, so as to favour the admission of water without shock and the utilization of the energy of the feed-water when moving ahead. The results were strikingly in favour of the twin-screw boat. She attained 10 knots with 90 I.H.P., while the jet-propelled boat, in her best trials after alteration, attained 8.12 knots with 78 I.H.P. Allowing for difference in speed, this indicates a superiority of nearly 60 per cent. in the expenditure of power in the twin-screw boat.

In 1881, the Admiralty instructed Messrs. Thornycroft to construct a second-class torpedo-boat, which should be fitted with a jet propeller, and compared with another boat of practically the same dimensions driven by a single screw. Both boats were fitted with boilers of the same size and type. The screw boat was 63 feet long, 7½ feet broad, and of nearly 13 tons displacement; her rival was over 66 feet in length, 7½ feet broad, and of nearly 14½ tons displacement. Every endeavour was made to increase the efficiency of the jet propeller when the boat was moving ahead. The inlet was placed at the bottom, and formed as a "scoop," so that the energy of the feed-water should be utilized as much as possible.* The turbine was designed to accelerate the water gradually, and the outlets were of short length with easy bends. The nozzles could be readily

* For full details and drawings, see Mr. Barnaby's paper above cited.

turned, and the jets delivered astern or ahead as desired. A considerable loss of efficiency when moving astern was accepted as a consequence of the "scoop" form of inlet. The total sectional area of discharge was rather under 1 square foot; the velocity of discharge was 37.25 feet per second, about 1 ton of water being discharged per second. Under these conditions, with nearly 170 I.H.P., this boat attained a speed of 12.6 knots per hour. The screw boat, with practically identical power, attained 17.3 knots per hour. An analysis of the efficiencies made by Mr. S. Barnaby gave the following results:—

In the screw boat the efficiencies were: engine, 0.77; screw propeller, 0.65; total, 0.5.

In the hydraulic boat the differences were: engine, 0.77; jet propeller, 0.71; pump, 0.46; total, 0.254.

The jet-propelled boat, therefore, was only about half as efficient as the screw boat, and the principal cause of loss was in the pump. The efficiency of the pump and jet in this boat was 0.33, as against 0.234 in the *Waterwitch*, showing a gain of 40 per cent., due to the utilization of the energy of the feed-water. This is the latest comparative experiment made in this country, and its results do not encourage the further use of the jet propeller except in special cases, such as the lifeboat above mentioned.

A jet-propelled vessel, with turbine, has also been built for the German Navy. She is said to have been about 170 tons displacement, and to have attained a speed of 7 knots with 292 I.H.P. In this case we are unable to give a comparison with a screw ship of similar form and power.

A novel experiment in jet propulsion was made (in 1879) in Germany by Dr. Fleischer, in a vessel named the *Hydromotor*, 110 feet long, 17 feet beam, with a mean draught of 6½ feet, her displacement being 105 tons.* It is claimed for this vessel that with 100 I.H.P. she attained a speed of 9 knots; but particulars of the conditions under which the speed trials were made were not given, and these conditions may have differed from those usual in English Admiralty measured-mile trials, where all possible care is taken to determine accurately the true mean speed, and to eliminate the influence of wind and tide. Apart from the reported performance, there were, however, features of great interest in this vessel. There was no centrifugal pump, but the steam acted directly upon the water in two reservoir cylinders placed above two large pipes leading

* For particulars see the two pamphlets entitled "Der Hydromotor" and "Die Physik des Hydromotors," by Dr. Fleischer. Kiel, 1881. See also *Engineering* of September 9, 1881.

to the nozzles, which were situated nearly amidships on either side of the keel. In each cylinder there was a "float" or piston of nearly the same diameter as the cylinder, and with a closed spherical top. When the cylinder was full of water, this float was at the upper part of the cylinder; when steam was admitted into the top of the cylinder, it pressed the float down and expelled the water at a high mean velocity. After a certain portion of the stroke had been made, the admission of steam was shut off automatically, and the rest of the stroke was performed by the expansion of the steam, the velocity of ejection decreasing as the float approached the bottom of the cylinder. The exhaust valve to the condenser was then opened, and as the steam rushed out from above the float a vacuum was formed, and the water entered the cylinder partly through the ejecting nozzle and partly from a separate valve communicating with the water-space of the surface condenser. The float was thus raised again to the top of the cylinder, after which the operations described were repeated. In the *Hydromotor* there were two cylinders working alternately; Dr. Fleischer proposed in larger or swifter vessels to use a larger number of similar cylinders. The cylinders were placed as high as possible in the vessel, so that the vacuum produced by the exhaustion of the steam might be utilized in raising a column of water above the sea-level, thus adding an effective "head" of water to the steam pressure during the down stroke. In the *Hydromotor*, rather less than 12 cubic feet of water were expelled per second at a mean velocity of 66 feet per second. The efficiency of the jets must have been low, therefore, even if the speed of 9 knots was reached.

Dr. Fleischer supposed that considerable economies would be obtained by abolishing centrifugal pumps, and simplifying the mechanism by which motion was given to the jets; and it may be admitted that this was possible. On the other hand, there were unavoidable losses. Although the cylinders were wood-lined, condensation of steam must have taken place in the cylinders. The velocity of ejection was variable as well as high, and two or more cylinders were essential to approximately continuous delivery. Dr. Fleischer claimed an efficiency of 34 per cent. at full speed; but the grounds on which this claim was based were not specified. The system does not appear to have been applied in any other vessel.

The theoretical investigations given above indicate the undesirability of using small quantities of water and high velocities of discharge; yet many recommendations and some experiments have been made in that direction, with unsatisfactory results. One of the latest of which public mention has been made, but not in a detailed or authoritative manner, is that of a vessel said to have been tried in America. The dimensions reported are: length, 106

feet; breadth, 23 feet; draught, 3 feet; and displacement, 100 tons. The water jets are said to have been only $\frac{3}{4}$ inch in diameter, and the velocity of discharge over 600 feet per second, about 1000 gallons (160 cubic feet) being discharged per minute. With these conditions it is not surprising that the results as regards speed were not satisfactory.

Apart from their relative efficiency, the use of jet propellers has been advocated for war-ships and in special cases, because they have the following advantages: greater freedom from damage in action, or fouling by wreckage or grounding; greater control by the commanding officer from the deck of the movements of the vessel ahead, astern, or in turning, without change in the motion of the engines; the possibility of applying the centrifugal pumps, fitted primarily for propulsion, to clearing rapidly large masses of water which may enter a ship whose skin is perforated. The first and second claims must be admitted, subject to the reservation that twin-screws also give great mobility (Chap. XVIII.). But the efficient realization of the idea that the centrifugal pumps should be available for pumping the hold spaces involves the necessity of a very serious interference with watertight subdivision. By common consent the maintenance of that subdivision is admitted to be of greater importance to the safety of ships than any possible increase in pumping power.* In view of their very inferior efficiency as propellers, therefore, the use of water jets is now confined to special vessels, such as floating fire-engines or lifeboats.

PADDLE-WHEELS.

Paddle-wheels, like jet propellers, give direct sternward momentum to streams of water, the reaction of which constitutes the thrust or propelling force. These streams form what is termed the "paddle-race"; and their cross-sectional areas depend upon the area and immersion of the paddle-floats. "Feathering" paddle-floats are now generally employed; in earlier practice the paddle-floats were often fixed radially upon the wheels. The *speed* of the floats depends upon their radial distance from the centre of the wheel and the number of revolutions of the wheel in a unit of time. Suppose the centre of the floats to be 16 feet from the centre of the wheel, and the wheel to make 16 revolutions per minute, then speed of floats in feet per second (V_1) would be given by

$$V_1 = \frac{2 \times 3 \cdot 1416 \times 16 \times 16}{60} = 26 \cdot 8 \text{ feet (nearly).}$$

* See a paper by the author "On the Pumping Arrangements of Modern War-ships," in the *Journal of the Royal United Service Institution* for 1881.

If the speed of the ship is called V , the difference ($V_1 - V$) between that speed and the speed of the paddle-floats is termed the *apparent slip* of the paddles, and is usually expressed as a fraction of V_1 or—

$$\text{Slip (per cent.)} = \frac{V_1 - V}{V_1} \times 100.$$

Suppose, in the example chosen—which is taken from an actual ship—that the speed V is 22·4 feet per second (about 13 knots per hour)—

$$\text{Slip (per cent.)} = \frac{26\cdot8 - 22\cdot4}{26\cdot8} \times 100 = 16\frac{1}{2} \text{ (nearly).}$$

From 20 to 30 per cent. appears to be a fair average for the slip of paddle-wheels when working under favourable conditions; in some cases a greater slip occurs.

The *real slip* of the paddle may differ sensibly from this apparent slip, because the water upon which the paddle-floats act has been set in motion by the advance of the vessel, and the character as well as the velocity of that motion varies at different positions. Ordinarily paddle-wheels are placed nearly amidships, where the “streams” surrounding a ship have their maximum sternward velocity relatively to the ship. The presence of the frictional wake may modify this relative motion near to the side of the ship, and the effective thrust may also be increased by an elevation (due to an increase of pressure) of the paddle-race above the normal water level.* Experience shows, however, that the wave phenomena accompanying the advance of ships moving at high speeds has a very important influence on the efficiency of paddle-wheels. Hollows frequently occur nearly amidships in the wave series, the water surface being lower than in still water, while the orbital motions of the particles of water involve an addition to their relative sternward velocities. All these circumstances may affect the efficiency of paddle-wheels placed amidships, and in some instances have greatly reduced that efficiency. In paddle-steamers of very shallow draught the paddles are commonly placed at the stern, where they act upon water having its least sternward motion, and where wave crests appear in the wave series at certain speeds. These conditions are more favourable to efficiency; but, on the other hand, the “augment” of resistance is likely to be greater than with paddles placed amidships and outside the main breadth of the vessels. Even in the latter case a considerable augmentation of resistance, as

* See on this point Professor Cotterill's paper in the *Transactions* of the Institution of Naval Architects for 1887.

compared with the condition when towed, is likely to be produced by the action of paddles. The water in the paddle-race is driven astern with considerable velocity, and the stream-line system is disturbed in a manner involving increased resistance. The paddle-floats rarely dip more than one-third to one-half of the draught of water; but while they do not affect the whole mass of water in the stream-line system, they act directly upon that portion which flows round the upper and fuller portion of the stern, and consequently produce a sensible augmentation. The late Dr. Tideman made some model experiments on this subject, using model paddle-wheels mounted in models of ships. The published results indicate considerable variations in the augmentation, and are hardly to be taken as conclusive. In one series paddles, a single screw, and twin-screws were tried, and the former caused the greatest augmentation.* More recent experiments have been made with models in connection with the designs of very fast Channel steamers, propelled by paddles. The results have not been published, but it is stated that the use of models has been of considerable advantage in arranging the sizes, positions, and character of the paddle-wheels.

Paddle-wheels necessarily do a considerable amount of work besides that which is effective in propelling a ship. This waste work includes that done in overcoming the resistance offered by the water to the entry and exit of the floats, in "churning" the water, driving it in other than the sternward direction, and in sudden increases in velocity of the water acted upon. Various devices for reducing waste work have been tried, including feathering floats, special forms of floats, differences in the breadth and depth of floats, and in the diameter of wheels. From the explanations given above, it will be obvious that the minimum amount of waste work must be considerable, since the "race" of the paddles must have a considerable sternward velocity and energy.

If the paddles be assumed to act upon water which is undisturbed by the passage of the ship, and the other causes of waste work just mentioned are neglected, it is possible to express their thrust in a simple form. Let A = the cross-sectional area of the paddle race on both sides. Then, using the previous notation—

$$\left. \begin{array}{l} \text{Cubic feet of water acted} \\ \text{upon per second.} \end{array} \right\} = AV_1$$

$$\begin{aligned} \text{Thrust of paddles (pounds)} &= \frac{(V_1 - V)}{g} \times AV_1 \times w \\ &= 2AV_1(V_1 - V) \text{ nearly for sea-water.} \end{aligned}$$

* See the record of the experiments in the *Memorial van de Marine* (9° Afl-e-vering): Amsterdam, 1878.

With the common (or "radial") float A is generally assumed to equal the transverse measurement (or length) of the floats into their maximum depth of immersion ; with feathering floats A is assumed equal to the area of the floats.

In the practical work of designing paddle-steamers, two of the most important governing conditions are the number of revolutions per minute proposed for the engines and the intended speeds of the vessels. Experience in other vessels is necessarily the best guide as regards probable "slip" of the paddles at full speed, with suitably designed wheels and areas of floats. Assuming a certain percentage of slip, the circumferential speed of the floats can be estimated, and hence the diameter of the wheels ascertained, which, with the given number of revolutions of engines and speed of vessel, will give this slip. There is a great range of practice in relation to revolutions, and it is necessary to proceed with caution in any new design when fixing on the rate of revolution. In a large number of high-speed paddle-steamers the revolutions have been from 20 to 30 per minute ; in certain cases they have risen to 40 or 50, and in special vessels to 70. Increase in the rate of revolutions, of course, secures greater lightness in the engines for a given indicated horse-power. On the other hand, if the "slip" is supposed to remain unchanged, as well as the augmentation of resistance, while revolutions are varied—assumptions not likely to hold absolutely true in practice—a smaller diameter of wheel must be employed. The following symbolical expressions are useful only in making comparisons between ships which have been tried, and new designs fairly close to them.

Let N = number of revolutions of engines per minute.

D = diameter of wheel (to centre of feathering floats).

s = assumed percentage of slip.

Then—

$$V_1 = \left\{ \begin{array}{l} \text{circumferential velocity} \\ \text{at centre of floats} \end{array} \right\} = \frac{\pi}{60} \cdot D \cdot N \text{ (feet per second)} \quad . \quad (1)$$

$$s = \frac{V_1 - V}{V_1} \times 100; \text{ whence } V_1 = \frac{100}{100 - s} \cdot V \quad . \quad . \quad (2)$$

Equating these two values of V_1 —

$$\frac{100}{100 - s} \cdot V = \frac{\pi}{60} \cdot D \cdot N \quad . \quad . \quad . \quad (3)$$

If the speed of the vessel is given in knots, it can be converted into feet per second by multiplying it by 1.688. Further, it will be seen that—

$$\begin{aligned} \text{Thrust (for)} \\ \text{sea-water)} \} &= 2A \cdot V_1(V_1 - V) = 2A \cdot \frac{100}{100-s} \cdot V \times \frac{s}{100-s} \cdot V \\ &= \frac{200 \cdot A \cdot s \cdot V^2}{(100-s)^2} \end{aligned}$$

Taking 25 per cent. as a fair average value for the slip, these expressions may be reduced to simpler forms as follows:—

$$D \cdot N = 25 \cdot V \text{ (roughly)} \quad . \quad . \quad . \quad (4)$$

$$A \cdot V^2 = \frac{9}{8} \times \text{thrust (in pounds)} \quad . \quad . \quad . \quad (5)$$

While formulæ of this kind are useful for purposes of comparison, practical rules based on experience are generally preferred for guidance. These may be briefly summarized: * The size of the wheel must be determined by comparison on the basis of intended speed, revolutions, and slip. The height of paddle-shaft must be so regulated that, at the deepest draught of the ship, not more than one-third to one-half of the radius of the wheel shall be immersed; while in the light condition the upper edges of the paddle-floats shall be a few inches under water when they are vertical. In vessels where the variation of draught is small, it is usual to follow the rule named for the light condition. The transverse measurement (or length) of the floats should, as a rule, not exceed one-third to one-half the breadth of the ship. In special vessels a greater length may be used. In a common paddle-wheel with radial floats, the number of floats should about equal the number of feet in the diameter, and the breadth is usually about $\frac{3}{4}$ inch to 1 inch for each foot in the diameter. With feathering floats, about half the number of floats should be used as with common paddle-wheels, and they should be individually about twice as large. Shallow-draught vessels require to be specially treated.

* Chiefly taken from the late Mr. Scott-Russell's work on "Naval Architecture."

CHAPTER XVI.

THE SCREW PROPELLER.

BEFORE proceeding with the discussion of the special features of screw propellers, it will be desirable to explain a few of the terms that will be frequently employed. The *diameter* of a screw is measured from the circle swept by the tips of its blades during their revolution; the area of this circle measures the *screw-disc*. The *pitch* of a screw is the length of a complete turn measured parallel to the axis; in other words, it is the distance which the screw would advance in one revolution if it worked in a solid nut. The *speed* of a screw is the distance it would advance in a unit of time if it worked in such a nut, and is clearly equal to the product of the number of its revolutions, in that unit of time, by the pitch.

Screws usually have two, three, or four blades, united by a central "boss" which fits upon the after end of the propeller shaft. Each blade may be regarded as a slice or section of a helical surface cut off by planes at right angles to the axis of the cylinder on which the helix is generated; the distance between these planes of section is known as the "length" of the blade. The number of helical surfaces (corresponding to the number of "threads" on a common screw) from which the blades are cut is equal to the number of blades. The sum of the areas of all the blades is known as the "blade-area," or "developed area," and this excludes the boss. This must be distinguished from the "projected blade-area," which represents the sum of the areas of projections of the blades on one of the planes of section. The edge of the blade which first meets the water when a ship is moving ahead is known as the "leading" edge; the other is called the "following" edge. The after surface of the blades is termed the "driving" surface or "face"; and the other surface is known as the "back" of the blades. The back of the blades is usually well rounded (sections of the driving face by cylinders of different radii giving approximately straight lines), so that strength may be secured in association with sharp edges. It is now recognized that great attention should be given to the condition of

surface, and to the sectional forms of blades, in order to minimize waste work on frictional and edgewise resistance to the motion of the screws, especially in ships of high speed, and with screws making a large number of revolutions per minute.

In some cases the blades, instead of being portions of true helical surfaces with "uniform" pitch, are made with "varying" or increasing pitch from the leading to the following edges. The "mean" pitch is then ascertained by measurement, and used in all estimates of performance. The ratio of the pitch to the diameter is termed the "pitch ratio"; the ratio of the length of the blade to the pitch is termed the "fraction of the pitch" in comparing different screws.

Suppose a screw propeller to be carried forward through undisturbed water at the speed of V feet per second, being mounted ahead of a suitably designed framework. As it advances let it be rotated N times per second; if the mean pitch be p feet—

$$\begin{aligned} \text{Speed of advance of the screw} &= V \\ \left. \begin{array}{l} \text{Speed of screw, corresponding to revolutions} \\ \text{and pitch} \end{array} \right\} &= V_1 = N \cdot p \\ \text{Slip of screw} &= V_1 - V \\ \text{"Slip-ratio" of screw} &= \frac{V_1 - V}{V_1} \\ \text{Slip of screw (per cent. of its speed)} &= \frac{V_1 - V}{V_1} \times 100. \end{aligned}$$

For example, take a screw making 72 revolutions per minute with a pitch of 14 feet, the speed of advance being 8.2 knots.

$$\begin{aligned} \text{Speed of advance} = V &= 8.2 \times 1.688 = 13.8 \text{ feet per second} \\ \text{Speed of screw} = V_1 &= \frac{72 \times 14}{60} = 16.8 \quad \text{" " " "} \\ \text{Slip of screw} &= V_1 - V = 3 \\ \text{Slip ratio of screw} &= \frac{V_1 - V}{V_1} = \frac{3}{16.8} = \frac{1}{5.6} \\ \text{Slip of screw (per cent.)} &= \frac{3}{16.8} \times 100 = 17.85. \end{aligned}$$

Under these circumstances the screw would be delivering a "race" or column of water, and the sternward momentum created per second measures the thrust (T). This might be measured by a dynamometer, and it may be assumed to have been so measured. Suppose, also, that measurements are made of the turning moment M required to keep the screw revolving at the assigned number of revolutions; then the following expressions hold good:—

$$\text{Useful work done per second} = T \times V \text{ (foot-pounds)} \quad . \quad . \quad (1)$$

$$\text{Total work} \quad \quad \quad = M \times 2\pi \times N \quad \quad \quad . \quad . \quad (2)$$

$$\text{Efficiency} = \frac{\text{useful work}}{\text{total work}} = \frac{T \cdot V}{M \times 2\pi \times N} = \frac{T}{M \times 2\pi \cdot \frac{N}{V}} \quad . \quad . \quad (3)$$

For any assigned speed of advance V , it may be supposed that the experiment described is repeated several times, and for each experiment a different number of revolutions is given to the screw; in other words, the percentage of slip is varied. The thrust and turning moment are measured in each case. Then for the given screw this series of experiments furnishes information of the influence of variations of slip upon efficiency. This information is usually

FIG. 157.

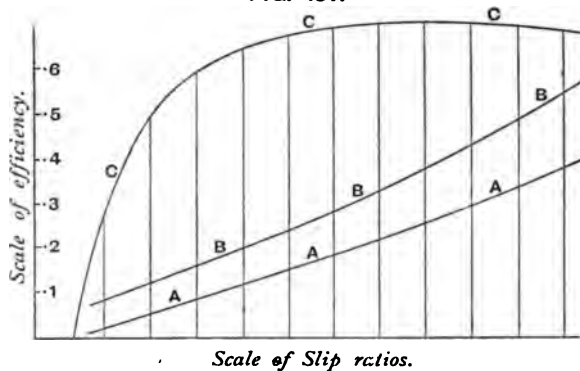

embodied in curves like those in Fig. 157. Abscissæ measurements represent revolutions and slip percentages or ratios. The ordinate at any point to the curve AAA represents the thrust T for the corresponding revolutions; that to the curve BBB represents the value of $M \times 2\pi \cdot \frac{N}{V}$ for the same revolutions; that to the curve CCC represents the efficiency for those revolutions. The zero of the curves is clearly at that number of revolutions where the speed of advance and speed of the screw are equal, and there is no slip or thrust.

It is desirable to consider more closely the movement of the water as affected by the revolution of the screw. From what has been said above, it may be assumed that for a well-immersed screw this water forms a column of circular cross-section at any point. Before the screw, the water in this column may be assumed to be receiving a gradual acceleration, almost entirely in the sternward direction. In passing through the propeller the water must receive

a further and final sternward acceleration, while it at the same time is given a rotary motion. This combination of sternward and rotary motion must make the particles move in spiral paths. Moreover, the rotary motion must be accompanied by centrifugal force, which involves a diminution of pressure from the centre of the column towards its outer surface. If the race be supposed to be practically cylindrical abaft the propeller, then in passing through the propeller its sectional area must be diminished, because its sternward velocity must be increased. Also in proceeding from the outer or bounding surface of the race, where the full pressure is maintained, towards the centre of the race, there must be a gradual diminution of pressure. The water delivered by the screw consequently enters a region of diminished pressure—resulting from the rotation of the race—and the impulse requisite to give the final sternward acceleration is less than it would be if there were no rotation. In other words, for a given thrust, which involves a constant sternward momentum, the effect of rotation is to cause a larger proportion of the total acceleration to be imparted before the water passes through the propeller than would be imparted if there were no rotation.* Mr. R. E. Froude has made a theoretical investigation of the problem, and has come to the conclusion that “the error due to ignoring the “effect of rotation-suction is not very material, though it becomes “tangible when both slip ratio and pitch ratio are high.”

In the experimental investigation above described, the whole phenomena are summed up in the measurement of thrust and turning moment. Knowing the slip, or mean sternward velocity impressed on the water, and the thrust, an approximation can be made to the quantity of water acted upon per second. The measured turning moment includes the force required to overcome all the resistances to the rotation of the screw, but does not separate those incidental to frictional or edgewise resistance of the water to the motion of the screw. Approximations may be made to the latter resistances on the basis of separate experiments, but direct calculation cannot up to the present time give a trustworthy evaluation of either thrust or turning moment for a screw working under the simple conditions of advance through undisturbed water.

A screw placed behind a ship presents a still more difficult problem. It acts upon water which has already been set in motion by the advance of the ship, and (as explained at p. 455) the motions

* Mr. Thornycroft drew attention to this matter in a discussion reported in the *Transactions* of the Institution of Naval Architects for 1889; and it has

been dealt with admirably by Mr. R. E. Froude in the same *Transactions* for 1892.

of particles at different parts of the "wake" upon which the screw acts vary greatly both in direction and velocity. Again, the action of the screw disturbs the stream-line motions natural to the speed of advance, supposing the ship were towed instead of being propelled, and the resistance is correspondingly augmented. Suppose the experimental apparatus above described, for a screw advancing through undisturbed water, to be modified by the addition of a model ship placed before the screw and towed by dynamometric apparatus. Further, suppose that, by means of a series of experiments, conditions were finally reached giving an exact balance between the measured resistance of the model and the measured thrust of the propeller. The experiment would then correspond to the conditions holding good when the ship represented by the model is propelled by her screw at the appropriate corresponding speed. It would be found that the resistance of the model ship would be more or less "augmented" by the action of the screw, that augmentation depending upon circumstances already explained. On the other hand, the fact that the screw acts upon a "wake" which has a forward motion relatively to undisturbed water would be found to give it an increased thrust for the number of revolutions and speed of advance, as compared with results obtained in undisturbed water. Mr. R. E. Froude has made a very large number of experiments of this nature on behalf of the Admiralty, and his deductions therefrom are of special interest.* So far as the "wake" affects the action of screws, it appears that no error of practical importance is caused by supposing the actual motions of the water to be averaged, as it were, a current of uniform velocity and direction being substituted for the varying velocities and directions of the wake within the limits of the screw action. Further, the horse-powers expended on screws propelling model ships, or delivering thrusts equal to their augmented resistances, differ extremely little from the horse-powers expended on the same screws exerting the same thrust at the same revolutions per minute in undisturbed water. If the model ship were removed, and its place taken by a "phantom ship" capable of resisting "the thrust of a screw, but creating no disturbance in the water," the speed of advance (V) remaining the same, and the screw revolving at the same revolutions per minute, then its thrust would be diminished, because there would be no wake. If, as a next step, the speed of advance were diminished while the revolutions of the screw remained the same, the "slip" would be increased, and the thrust of the screw correspondingly increased. At some speed of advance (v) therefore, of the "phantom ship," the thrust of the screw for a

* See *Transactions* of the Institution of Naval Architects for 1883 and 1886.

given number of revolutions, would be identical with that of the screw propelling the model at a speed V , the revolutions of the screw being the same in both cases.

Let T = thrust of screw in pounds, which equals the tow-rope resistance of the model at the speed v . Then—

$$\text{Thrust horse-power} = T \cdot v \quad \dots \dots \dots (4)$$

Let R = tow-rope resistance of the model ship at speed V .

$$\text{Effective horse-power} = R \cdot V \quad \dots \dots \dots (5)$$

Also if at the speed V the indicated horse-power be called I.H.P., and the waste work of engines on friction, etc., be supposed proportional to the indicated horse-power (see p. 544); then if c be a constant depending on the proportion of the indicated horse-power delivered at the end of the screw shaft—

$$e_1 = \text{Efficiency of screw when propelling actual ship} = c \frac{\text{E.H.P.}}{\text{I.H.P.}} \quad \dots (6)$$

$$e_2 = \text{Efficiency of screw when propelling phantom ship} = c \frac{\text{T.H.P.}}{\text{I.H.P.}} \quad \dots (7)$$

$$\frac{e_1}{e_2} = \frac{\text{E.H.P.}}{\text{I.H.P.}} \div \frac{\text{T.H.P.}}{\text{I.H.P.}} = \frac{\text{E.H.P.}}{\text{T.H.P.}} = \frac{R \cdot V}{T \cdot v} \quad \dots \dots \dots (8)$$

This ratio of the efficiencies Mr. R. E. Froude terms the "hull efficiency," and remarks that there are two factors influencing it. The first, $R \div T$, expresses the amount by which the resistance is less than the thrust for the speed of advance V . The second, $V \div v$, represents the excess in the speed of advance of the screw over its speed through the water in which it works. "Concerning these two factors "of the hull efficiency," he adds, "they appear to be to a great extent "inter-dependent; the conditions which increase the wake-gain tend "generally to increase the thrust-deduction loss; and the product "(the 'hull efficiency') is therefore, roughly speaking, constant. It "is, in fact, roughly equal to unity in all cases. Such variations as "do exist in the value of hull efficiency appear to mainly accompany "differences in shape of hull, or in position of screw in reference to "it, rather than differences in size or proportion of screws with the "same hull." This most important conclusion rests upon such a basis of experimental facts that it may be accepted as practically correct. Its main value is found in the circumstance that, by adopting it, all questions of screw efficiency can be experimentally investigated in undisturbed water, and the deductions applied to ship propulsion.

It is assumed, in the foregoing remarks, that the forms of the after parts of screw-steamers are such as to permit of the free flow of water to the screws. Fineness in the run, and the avoidance of

blunt forms behind which "dead water" could accumulate, are now universally recognized as essentials to efficiency of propulsion, and are of the greatest importance in single-screw ships. In the earlier periods of screw propulsion, this was not so well understood, and great waste of power resulted. Many of the "converted" ships in the Royal Navy, built for sailing only, and afterwards altered into screw-steamers, had the screw apertures formed in the after-deadwoods, with flat-ended recesses. Other vessels were built with full sterns, and the existence of thick wood stern-posts and rudder posts also involved considerable waste of power. Experience very soon proved the necessity for finer forms. As an example, the screw-frigate *Dauntless*, built in 1848, may be mentioned. Her stern was at first very full, and her performance so unsatisfactory that she was lengthened aft about 10 feet, and given a much finer run. With the same propelling machinery and screw as before, a much better performance was secured. In the earlier trials, with 836 I.H.P., she attained 7.3 knots; after alteration she attained about 10 knots with 1388 H.P. The alteration in the stern not merely increased screw efficiency, but diminished resistance, and effected a saving in power of fully 30 per cent. at the maximum speed.

Screw efficiency also depends upon the proper immersion. The upper blades should not be allowed to break the surface of the water, or draw down air, if full efficiency is to be secured.* So long as the surface is not broken or air drawn down, the atmospheric pressure supplies a "head" equivalent to about 33 feet of water, and effective for causing the water to follow up the movements of the propeller blades. When this "head" is lost, the flow of water to the propeller must be affected, and efficiency decreased. Moreover, the splashing and churning of the water at the surface represents waste work and diminished thrust. Partial emersion of screws may result from vessels being at a lighter draught, as when cargo-steamers are without full cargoes, or from "pitching" at sea. In no case, however, can it fail to be accompanied by reduced efficiency. Trials have been made of plans to secure deeper immersion, and freedom from "racing" when pitching. One of the most important experiments was that made in the White Star steamer *Britannic*, where the screw and after portion of the shafting could be lowered when in deep water. The results were not satisfactory, and the plan has not been continued in use. Twin-screws have an advantage over single screws as regards possible depth of immersion and its consequent gains.

* See Professor Osborne Reynolds' paper in the *Transactions* of the Institution of Naval Architects for 1873; and the remarkable illustration of the effect of "splashing" given by Mr. S. Barnaby in his "Marine Propellers."

Theories of the Screw Propeller.—Many attempts have been made to establish a theory for screw propellers, and to frame mathematical formulæ for deciding on the best forms and dimensions. These theoretical investigations have been of considerable service in advancing conceptions of the phenomena of screw propulsion, and the causes contributing to efficiency. In assisting and guiding experimental work they have also been of value. But it is still true that we are chiefly dependent upon experience and experiment, aided by mathematical analysis, in determining the most suitable screw propellers for individual ships. A short account of these theoretical investigations must suffice, therefore, and readers desirous of following them up may refer to the original publications.

The late Professor Rankine laid the foundation on which all subsequent investigators have proceeded, to some extent, in dealing with the mechanical principles of the action of propellers.* For screws, he assumed that the number and surface of the blades would be adjusted, on the basis of past experience, so as to give sternward motion to the whole of the water in which the screws revolved. The race was assumed to consist of a cylindrical column of water, having for its cross-section the disc area of the screw, less the sectional area of the boss. It was made a condition that the flow of water to the screw should be ample. Little was said respecting the method in which sternward and rotary acceleration were supposed to be impressed on the water, but it would appear that this was assumed to happen in the short interval occupied by the water in passing through the propeller. The motions of the particles in the race, after passing through the propeller, were supposed to be of a spiral character, including both sternward and rotary movements. At a given radial distance from the axis of a screw, particles were assumed to have identical motions impressed upon them by the action of those annular elements of the screw blades which would be cut off by a cylinder, having the given radial distance as its radius, and a very small thickness. The race was conceived to be made up of a series of concentric hollow cylinders, "each having a rotatory motion and a sternward motion; these motions being, in general, different for each cylinder, so that they would slide through each other and rotate within each other." On these assumptions, approximations were made to—(1) the quantity of water acted upon by the screw in a unit of time; (2) the sternward momentum generated in a unit of time; (3) the waste work expended in overcoming the friction of the blades; (4) the change in efficiency produced by the action of the blades on water which had been previously disturbed by the advance of the ship. Mathematical formulæ were framed for all

* See *Transactions* of the Institution of Naval Architects for 1865.

these quantities, and practical applications made to the determination of the dimensions of screws suitable for various ships moving at assigned speeds. For any ship the resistance corresponding to the intended speed was first approximated to; and so was the mean speed of the wake in which the screw would work. It was assumed that a certain apparent slip of the screw would be accepted; consequently the speed of the screw, and its real slip relatively to the water it worked upon, were known. Hence, by means of mathematical formulæ, the disc area and diameter of the screw considered most suitable were determined. The numbers, areas, and forms of the screw blades were left to be determined from experience with other vessels. Rankine's formulæ assumed certain values for coefficients of friction, and other particulars which cannot be accepted in view of later experiments. His rules rested, however, on scientific principles, and were framed in a manner worthy of his high reputation. The fact that they have but little influenced practice indicates that the method suggested required to be so far supplemented by experience, that most naval architects and engineers have preferred to depend upon direct comparisons with vessels of which the performances had been recorded.

Another purely theoretical presentation of the action of the screw propeller has been made by Professor Greenhill.* It is unnecessary to do more than summarize the principal steps of this investigation. First, the rotation of the race was calculated from the velocity of the water as it leaves the propeller, on the assumption that particles move in planes perpendicular to the axis, and at constant angular velocity. Then the angular momentum was estimated, and the turning couple of the engines deduced from it. By the principle of virtual velocities the thrust of the propeller was deduced from the turning moment, and the conditions of pressure accompanying the rotation of the race were investigated. In Professor Greenhill's words, "The change of momentum and the change of pressure are the two causes at work in obtaining propulsion. . . . It is instructive to discuss a case in which the second question only operated, and to compare it with the theory of Rankine in which the first cause alone is considered." Professor Greenhill, therefore, deals with an ideal case in supposing the propeller to impart a purely rotary motion to the race; and while his investigation has considerable interest and suggestiveness, it does not profess to represent the actual conditions in the race of a screw, where particles necessarily have sternward as well as rotary motions imparted to them in passing through the propeller.

* See his paper in the *Transactions* of the Institution of Naval Architects for 1888, and Mr. R. E. Froude's remarks thereon in the same *Transactions* for 1889.

The late Mr. Froude added much to existing knowledge of the action of screw propellers, both by experimental and by mathematical investigation. One of his latest contributions to the subject was in some respects the most important, and requires to be noticed at some length. Mr. Froude desired to demonstrate the fact that increase in the diameter and surface of screw propellers, while it enabled a larger quantity of water to be acted upon, might be accompanied by such an increase in waste work on the blades—representing frictional resistance, or edgewise resistance—as would make it advantageous to use screws of less diameter and surface, but with greater pitch. At the time the lesson was much needed.*

In order to bring the problem into a form admitting of readier solution, Mr. Froude assumed the screw to work in undisturbed water, making no correction for wake. It is necessary to remark, however, that in other papers he had completely sketched the principal features of wake motion, and their influence upon screw efficiency.

For the special purpose in view, Mr. Froude desired to show how the sternward momentum was imparted to the water by a screw, and what waste work was involved in the operation. He therefore framed equations for the action of an annular element of the area of a propeller blade, situated at a given radial distance from the axis, and having a known angle of obliquity to an athwartship plane standing at right angles to the axis. This elementary propeller would have a certain speed of advance (that of the ship) and a certain athwartship motion (due to rotation). Its actual motion relatively to the water would be compounded of these two motions; and thus its actual motion and obliquity could be ascertained. Mr. Froude treated this elementary propeller as a plate moving obliquely (the case discussed at p. 440). He estimated the normal pressure on the plate, and the frictional resistance involved in its passage through the water. These forces were resolved into their longitudinal and transverse components. The difference between the longitudinal components of the normal pressure and the frictional resistance measured the effective thrust; the product of this into the speed of advance measured the useful work. The sum of the transverse components of the two forces multiplied by the distance the centre of the elementary area travelled in its circular path in the unit of time, measured the total work. Hence an expression for the efficiency—the quotient of the useful work by the total work—was obtained for the elementary propeller. Applying differential methods to this expression, it was possible to show how the efficiency varied with changes in the pitch

* See the *Transactions* of the Institution of Naval Architects for 1878. The trials of H.M.S. *Iris* (mentioned hereafter) were then of recent occurrence.

(or obliquity), slip, and area for a given speed, and what combination gave maximum efficiency.

Passing from the element to the whole propeller blade, Mr. Froude assumed that it might be converted into a plane area with an equivalent or mean angle of obliquity; he thus applied to the propeller as a whole deductions made from the investigations for an element. This step is open to question, for reasons which will be apparent from preceding remarks. Differences of behaviour must arise when a large and continuous area of varying obliquity is substituted for a series of independent and individually small elements of that surface. Questions of variation of pressure in the race necessarily have to be considered, as well as the disturbance of the water by the action of certain blades or portions of blades before it comes under the influence of the other blades or portions of blades. These considerations could not have been absent from the mind of Mr. Froude when he framed the following deductions, and they must not be overlooked when considering the practical value of his suggestions and conclusions, which may be summarized as follows: First, for maximum efficiency, the mean effective angle of the screw blade, measured from an athwartship plane, or "pitch-angle," should be 45 degrees, which is obtained when the pitch is about twice the extreme diameter. Second, for maximum efficiency, the slip-angle must vary directly as the square root of the coefficient of friction, and inversely as the square root of the coefficient of normal pressure, which gives a slip of about 12½ per cent., with the values of the coefficients adopted in the investigation. This is the *real slip*; the *apparent slip* will usually be less, and will vary according to the amount and character of the disturbance of the water in which the screw works. Third, that, for maximum efficiency, the area of the screw-blades may be expressed approximately by the formula—

$$\text{Area (in square feet)} = 8.9 \times \frac{R}{v^2};$$

where R = the resistance of the vessel (in pounds) at her maximum speed v (in feet per second).

Fourth, that since at moderate speed the resistance of a ship varies as the square of her speed, the same propeller should, within those limits of speed, drive a ship with the same percentage of slip; but that above those limits of speed the percentage of slip should increase.* Fifth, that for moderate speeds, if the blade areas of the

* In the case of torpedo-vessels, when driven at very high speeds in proportion to their lengths (see p. 472), the resist-

ance varies at a less rate than the square of the speed, and it is found that the slip decreases.

screws of two similar ships have the ratio of the squares of the respective dimensions, the percentage of slip should be the same. Sixth, that, if two ships have the same resistance at different speeds, the area of screw blades which will overcome the resistance while maintaining a given slip will be less, in the ratio of the squares of the speeds, for the ship which has the higher speed. The last three deductions are obtained from the formula for blade area. Seventh, that the maximum efficiency which can be realized under the most favourable conditions is about 77 per cent. ; but that the percentage of slip might be increased considerably (even as high as 30 per cent. with the screw working in undisturbed water) without any serious decrease of efficiency in screws of ordinary proportion.

An attempt has been made by Mr. Calvert to calculate the thrust and turning moment for screw propellers on the lines followed by Mr. Froude in the investigation just described.* The quantitative results for normal pressure and frictional resistance of an element of blade area are based by Mr. Calvert on the special series of experiments he conducted for that purpose, to which experiments allusion is made at p. 441. Allowance is made in this calculation for the varying obliquity of different annular elements of the blades, for the forward movement relatively to undisturbed water of the wake in which the screw works, for the "real" as distinguished from the apparent slip, and for the velocity of the element through the water. In a specimen calculation for a screw with four blades, 10 feet in diameter and 15 feet pitch, the efficiency was found to be 0.679, which is probably not far from correct. On the other hand, the remarks made above, as to the difference between the behaviour of an elementary propeller, or series of such propellers, and a screw blade, apply here also.

Professor Cotterill followed up the investigation of the late Mr. Froude by another, in which he indicated how the two methods of inquiry pursued by Rankine and Froude were related to one another ; as well as the form of blade area which would be required to fulfil the condition laid down by Rankine, viz. that the whole column of water having the screw disc for its cross-section shall be given sternward acceleration. In this and a subsequent paper Professor Cotterill has done much valuable work, particularly in regard to the conditions of velocity and pressure which exist in the water surrounding ships in motion, or acted upon by propellers. The contributions of Mr.

* For details see the *Transactions* of the Institution of Naval Architects for 1887.

† See the *Transactions* of the Insti-

tution of Naval Architects for 1879 and 1887 ; as well as remarks on Mr. R. E. Froude's papers of 1889 in the same *Transactions*.

Thornycroft to this and other branches of the theory of screw propulsion have also been valuable. Some of them have already been mentioned, and his experimental investigations are referred to hereafter.

Professor Maurice Fitzgerald has attacked the problem of screw propulsion in another way. He endeavours to assign reasonable values to the longitudinal and circumferential velocities of the water in the screw race, such that they "would make the resistance to rotation (due to the inertia of the water like that of a heavy frictionless nut on a screw) the thrust (due to the same nut), and the head or pressure in the stream lines which depends on both the circumferential and longitudinal velocities, consistent with one another." Having obtained such values for these velocities, he then ascertains what form of vortex would agree with the movements of the race, and estimates the power expended in producing such a vortex. Applying the method to a number of cases, Professor Fitzgerald found a fair agreement between this estimated power and the power actually delivered to the screws. His intention was to design the screw blades suitably so as to produce the longitudinal and circumferential velocities, and it is stated that the blades fulfilling this condition did not differ greatly from ordinary forms.*

The last investigator of the theory of the screw propeller to whom reference will be made is Mr. R. E. Froude. To him are due the most valuable and extensive additions to the literature of the subject made in recent years, including many original conceptions in regard to the action of propellers upon water. Besides this work, Mr. Froude has done much towards harmonizing and contrasting apparently conflicting theories, such as those of Rankine and Greenhill; clearing up branches of the subject which were previously obscure; and putting into a quantitative form various features of propulsion of which the relative importance had not been ascertained, although their existence and qualitative effects had been recognized. He has also continued and greatly extended, on behalf of the Admiralty, the experiments on model screws which were commenced by the late Mr. Froude. Repeated references have been made in preceding pages to his investigations, and they have already had a great influence upon practice in the designing of screw propellers.

The Determination of Dimensions for Screw Propellers.—In the design of screw-steamers the selection of a suitable propeller is of great importance in relation to economical propulsion. From the foregoing sketch of the theory of screw propellers, it will be seen that

* For details see the discussion on of the Institution of Civil Engineers for
"Screw Propellers" in the *Proceedings* 1890, vol. cii.

there are no complete or accepted rules for guidance in making the selection. Experience and experiment of necessity exercise great influence, and the recorded results of trials are invaluable when dealing with new designs. These trials may be arranged in two classes. First, what may be termed "full-scale" experiments made on ships or boats which are actually propelled by different screws. Second, "model" experiments made with small screws, in order to obtain information which can be used in the design of actual screw propellers. Again, these full-scale experiments may be subdivided into (1) trials made in ships on ordinary service; and (2) trials made on measured distances, special care being taken to ascertain accurately the speeds attained and the corresponding expenditures of power, in order to determine the relative efficiencies of different screws in the same ship.

Sea trials, on ordinary service, while they are of undoubted value, have to be made under very various conditions of wind and sea, and often with different degrees of foulness of bottom, different lading, and variations in the quality of coal used, or in the state of engines and boilers. All of these circumstances, of course, affect efficiency, and must be reckoned in the aggregate result. Usually the comparison is made in the simple form of average speed on a voyage, average power indicated, and average rate of coal expenditure. It may, and does happen, therefore, that the results obtained in many cases afford no fair or conclusive evidence of the relative efficiencies of the screws employed. To this fact is due, no doubt, many of the opinions expressed respecting the gains in speed and coal consumption supposed to have been realized by special and patented propellers. In order to obtain trustworthy results, which must necessarily be of a general character, sea trials of rival screws must be continued over long periods, and proper records kept of the loading, weather, condition of bottom, and working of machinery and boilers. Cases occur where the improvement or deterioration in performance accompanying a change of screw is so marked on actual service as to leave no doubt of relative merits. In general, however, the economies or losses resulting from such a change are not so strongly marked, and experience must be gained under varying conditions of service and of weather, over a long period, before it can be decided which screw is, on the whole, most advantageous. For smooth-water steaming one screw may have the advantage over another; and the conditions may be reversed in rough water. The latter case involves an increased resistance for a given speed, and a considerable effect on screw efficiency in consequence of pitching motions, both of which circumstances require to be recognized in fixing upon the diameter and blade area of screws.

Progressive Trials.—But while regard must be had to these conditions of sea service, it must be admitted that a much more exact measurement of screw efficiency, as influenced by changes in dimensions, form, and pitch, is possible when the trials are made in smooth water, under fairly exact and ascertainable conditions of speed and power. For this purpose it is necessary to have "progressive" trials at various speeds on the measured distance. At each speed a number of runs must be made with and against the tide or current, in order to eliminate its influence, the horse-power, revolutions, and mean speed being ascertained for each set of runs. This process, repeated for each screw tried at a considerable number of speeds, enables diagrams to be constructed, showing the expenditures of powers with each screw over the whole range of speed. Much has been done in this way during recent years, and particularly in connection with the construction of swift torpedo-boats running at unprecedented speeds. As an example take Fig. 158, which re-

FIG. 158.

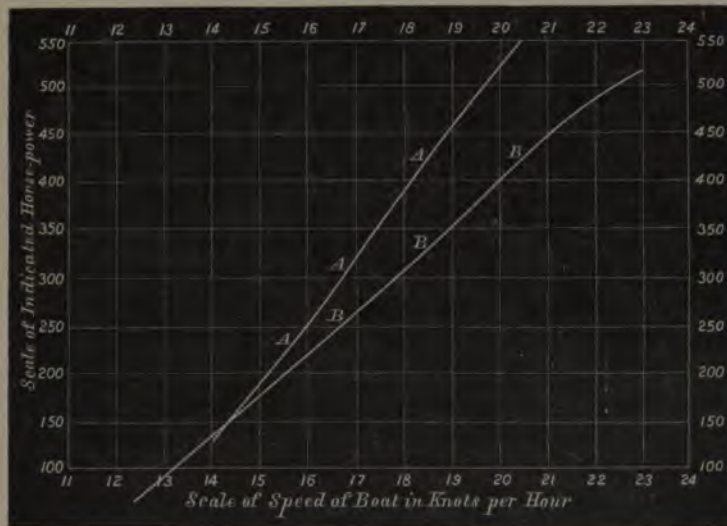

presents results obtained by Mr. Yarrow in a torpedo-boat which was tried progressively, with no less than twenty-five different screws. The diagram shows two extreme cases. The curve AAA records the ascertained performance of a two-bladed screw of 5 feet 6 inches diameter, 4 feet 6 inches pitch, having a blade area of 496 square inches. With 560 I.H.P., this screw drove the boat $20\frac{1}{2}$ knots per hour. The curve BBB belongs to a two-bladed screw 4 feet 4 inches diameter, 5 feet pitch, having 540 square inches of blade area. With 520 I.H.P., this screw drove the boat at the

remarkable speed of 23 knots per hour, $20\frac{1}{2}$ knots being attained with 430 H.P. With 500 H.P., the first screw gave the boat a speed of about $19\frac{3}{4}$ knots, and the other screw gave $22\frac{1}{2}$ knots. Some doubt attaches to the accuracy of the determination of the horse-power in torpedo-boats, on account of the very rapid movements of the indicators, but the comparative expenditure of power with these two screws is not likely to be affected by any such inaccuracy.

Another most extensive and valuable series of experiments was that made by Mr. Isherwood on the steam-launch mentioned on p. 542. Eight different screws were tried in this vessel. The highest speeds attained were only about $8\frac{1}{2}$ knots, but, having regard to the moderate length of the launch (54 feet), this corresponded to high speeds in ships of similar form and large dimensions. In these trials dynamometric results were obtained giving the thrusts of the screws at different speeds, while independent experiments were made to determine the nett-resistance (tow-rope) for the same speed. The results were analyzed in great detail, and the conclusions reached respecting many of the phenomena affecting screw efficiency were of very considerable value. To some of these reference will be made hereafter. Mr. Yarrow, in his trials with a first-class torpedo-boat described above, followed a similar method.

More recent experiments of this kind, presenting many interesting features, were conducted by Mr. W. G. Walker, of Bristol, in 1891, on a single-screw yacht 55 feet in length. Seven screws were tried, including screws with two, three, four, and six blades, with several variations in the relative positions of the four and six blades.* Mr. Walker has presented the results in full detail, and has analyzed them on the lines laid down by Mr. Isherwood.

Trials of this nature necessarily involve the expenditure of much time and labour, even when they are carried out on small steam-yachts or launches. For large ships driven by engines of considerable power the difficulties and laboriousness of the task are much greater; and it is only under special circumstances that it is attempted. One of the most notable instances is found in the experiments made with various screws on H.M.S. *Iris* in 1878. The results are recorded in Fig. 159. On her first trials she was fitted with twin four-bladed screws 18 feet $6\frac{1}{2}$ inches in diameter, with a mean pitch of 18 feet 2 inches, and a blade area of 194 square feet. The curve of indicated horse-power with these screws is marked AAA in the diagram. The results were very disappointing, and it was decided to remove two

* See an account of the experiments and an interesting discussion thereon in the *Proceedings* of the Institution of Mechanical Engineers for 1892.

of the four blades from each screw, leaving all other conditions unchanged. With this reduction in blade area the curve of indicated horse-power, determined from another series of trials, fell to BBB. The highest power developed was 4369 H.P., and the corresponding

FIG. 159.

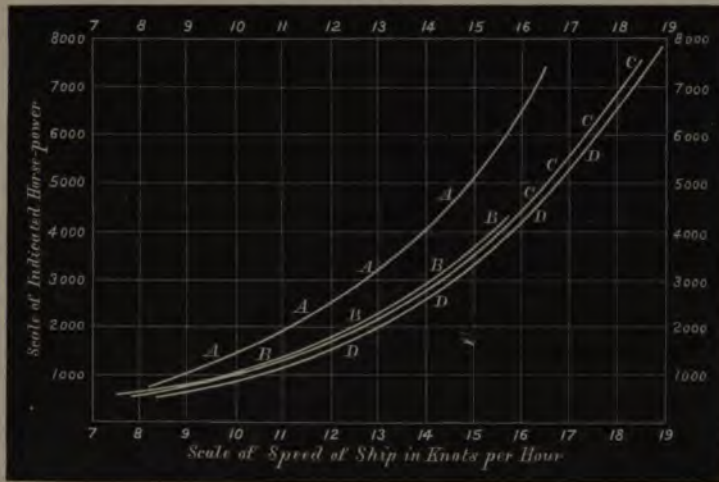

speed was $15\frac{3}{4}$ knots, whereas in the first series of trials 6200 H.P. was required for $15\frac{3}{4}$ knots, and 4369 H.P. corresponded to only $14\frac{1}{2}$ knots. These remarkable results led to fresh trials. The third series of trials was made with four-bladed screws, 16 feet $3\frac{1}{2}$ inches in diameter, 19 feet $11\frac{1}{2}$ inches pitch, with a blade area of 144 square feet; and the results are graphically recorded by the curve CCC. The performance will be seen to agree very closely with that of the preceding series of trials. Lastly, the vessel was fitted with two-bladed screws, 18 feet $1\frac{1}{2}$ inches in diameter, 21 feet $3\frac{1}{4}$ inches pitch, and having a blade area of 112 square feet. The trials made with these propellers are recorded in the curve DDD, and the performance will be seen to be rather better than that of either the second or the third series. Considerable vibration took place, however, with these screws at certain speeds, although there was no troublesome vibration at the full speed of 18.6 knots; and it was decided to accept the four-bladed screws of the third series as the working propellers. A most thorough analysis of these trials has been made; but there are many matters in the comparative performance of the screws which have, as yet, not received satisfactory explanation.* The broad fact remains, however, that with nearly the same indicated horse-power,

* See Sir James Wright's paper in the *Transactions* of the Institution of Naval Architects for 1879.

and with practically the same number of revolutions of the engines per minute, a change in the screws enabled the speed to be increased from $16\frac{1}{2}$ knots to $18\frac{1}{2}$ knots per hour. Or, to state the case somewhat differently, whereas on the first trial a speed of $16\frac{1}{2}$ knots required 7500 H.P. and 91 revolutions, on the third series of trials an equal speed was attained with 5100 H.P. and 85 revolutions.

Since the trials in the *Iris*, two similar series with screws of different patterns have been carried out in the *Medusa* third-class cruiser and the *Gleaner* torpedo-gunboat of the Royal Navy. In both instances valuable information was obtained, and sensible economies of power realized, especially at the highest speeds. In the *Medusa*, for example, an increase in speed from 19.5 to 19.9 knots was obtained with the same indicated horse-power, simply by a change of screws. These two series of trials had a special value also, in that they enabled a direct comparison to be made between the performances of full-sized screws and the deductions made from experiments with model screws.

Experiments with Model Screws.—Trials made with model screws, when properly conducted and interpreted, afford much greater facilities for investigating the causes affecting efficiency than are possible with full-scale experiments either on ships or boats. From explanations given in previous pages, it will be seen that in the full-scale experiments many and varying influences are at work, including the efficiency of the engines, the influence of wake, augmentation of resistance, and possible want of uniformity in the speed of advance. All these phenomena, of course, affect propulsive efficiency, and some of them affect screw efficiency. On the other hand, the causes which principally affect screw efficiency, and are capable of being dealt with in the design of the screw—such as diameter, pitch-ratio, slip-ratio, revolutions, and form and area of blades—can all be dealt with more simply, as well as more exactly, by means of experiments on model screws working apart from ship models and in undisturbed water. Such experiments require to be supplemented by others (similar to those mentioned on p. 602) where the model screws are operated behind the model ships. This is the order of procedure adopted for many years past in the Admiralty experimental establishment, and now in practice in the experimental establishments subsequently established at home and abroad.

Experiments with model screws have been common from the beginning of screw propulsion. The late Mr. Griffiths, Mr. Rennie, and many others used this method for special purposes. To the late Mr. Froude, however, belongs the honour of initiating the established system of experiment with model screws as well as with model ships. For each new type of ship added to the Royal Navy it has for many

years past been the rule not merely to determine experimentally the curves of resistance, but also to investigate the augmentation produced by the action of the propellers, and the most suitable propeller under the conditions of the engine design. Mr. R. E. Froude has largely developed and systematized this branch of experimental inquiry, and by permission of the Admiralty the principal results, as well as the methods, have been described by him in a series of valuable papers, from which are derived many of the facts and principles hereafter stated.* Other experimentalists have dealt with the subject in different ways, and have added to the information available for future guidance. Reference will be made to these also; although the range and scope of the inquiries do not compare with those carried out for the Admiralty, there are many interesting confirmations and some extensions of Admiralty results.

The principal objects of all these experiments may be summarized as follows: First, to ascertain for a given screw, working at different revolutions and with different slip ratios, how the efficiency varies with increase in slip. That is to say, what is the character of the efficiency curve such as CCC in Fig. 157. Second, to ascertain for screws of given diameter and blade area what is the effect upon efficiency of changes in the ratio of pitch to diameter, or pitch-ratio. Third, to ascertain how efficiency is influenced by changes in the numbers, forms, and dimensions of the blades. Fourth, to determine the laws of comparison between screws of the same design, but of different dimensions.

In practice, the selection of the most suitable screw for a new steamship must be made subject to certain governing conditions. A given maximum smooth-water speed at a certain draught and displacement is one of these conditions. For this speed the indicated horse-power required is determined with fair approximation on the basis of past experience or model experiments. Ordinarily the maximum number of revolutions is fixed for the engines and screws. The draught of water, in many cases, puts a limit on the diameter of the screws that can be used. In twin or triple-screw steamers this is not usually of much importance, but in single-screw vessels of shallow draught it is so, and this limitation of diameter often controls the engine design, so far as the revolutions are concerned. The number of engines and screws to be used is also a matter which may be taken as settled, whether single, twin, or triple. Accepting these fixed conditions, it is required to find the diameter, pitch, number of blades, and blade area in the screw propeller or propellers to be

* See the *Transactions* of the Institution of Naval Architects for 1883, 1886, and 1892; Mr. Froude's contribution to

the discussion on Screw Propellers in the *Proceedings* of the Institution of Civil Engineers for 1890.

used in the case under consideration. Past experience with other ships is usually depended upon in making this choice, but greater certainty is attainable by the help of model experiments, especially in deciding on the diameter and pitch of screws. Formerly there was great distrust of deductions from model experiments with screws as well as with ships. Now it is demonstrated, that with proper corrections and scales of comparison, the results obtained with model screws may be applied to full-size propellers. By means of model experiments, also, many obscure and doubtful features in screw propulsion have been elucidated, and certain general principles established. Extensions of knowledge are being continually made by means of comparisons between results obtained on carefully conducted steam trials with ships and the corresponding results of model experiments, and the whole subject is being put on a sounder foundation.

It may be well to describe briefly the principal series of model-screw experiments of which the results have been published.

The model screws used by Mr. R. E. Froude were 8·16 inches in diameter. The blades were elliptical in form, and the minor axis of the ellipse was four-tenths of the major axis, or radius of the screw disc. Four, three, and two bladed screws were tried, all with blades of the same shape. Most of the experiments were made with four-bladed screws, for which the total blade area was rather less than 40 per cent. of the area of the screw disc. The pitch of the screws was uniform. The ratio of pitch to diameter—pitch-ratio—was varied considerably in different models. Four series of trials were made with pitch ratios 1·225, 1·4, 1·8, and 2·2, and it was considered by Mr. Froude that he could safely extend these experimental results to pitch ratios as low as 0·8 or as high as 2·5. Each screw was carried forward at a speed of 206 feet per minute, with varying rates of revolution, and consequently with varying slip ratio. For each rate of revolution the thrust and turning moment were measured, and so curves of thrust, turning force, and efficiency were constructed like those in Fig. 157, with abscissa representing slip ratios. Under the conditions of the experimental works all these measurements could be made with great exactness, and they were carefully checked by repeating experiments, at each speed with each screw.

Mr. Thornycroft made an interesting series of trials in 1879–1880 for the purpose of determining an efficiency curve for a three-bladed propeller of his patented form.* The model screws were 9 inches in diameter, with a mean pitch of 10·3 inches, and a blade area of 16 square inches, or about 28·5 per cent. of the disc area. This was a less proportionate blade area than in the Admiralty

* See also the excellent work on "Marine Propellers."

experiments, and the blades were differently shaped, besides being bent backwards. The model screw was carried on a shaft projecting forward from the bow of a steam-launch, far enough to be working in practically undisturbed water. The launch was run at as nearly as possible the uniform speed of $4\frac{1}{2}$ knots per hour. The model screw was driven at varying revolutions and slip ratios. For each rate of revolution and slip its thrust and turning moment were measured, and a curve of efficiency was constructed like CCC in Fig. 157. A small change of pitch was tried on either side of the standard pitch, and in both cases the efficiency was somewhat reduced. This part of the experiment, however, had comparatively little value.

A third series of experiments with model screws, made by Messrs. R. and W. Hawthorn from 1882–1887, was differently conducted. The screws were stationary, and made to revolve in a tank with circular ends. By the motion of the screws the water in the tank was made to travel round the tank at a rate which was measured and allowed for in estimating slip. Twenty-five models of various forms and proportions were tested. Two objects were kept in view. First, to obtain information respecting the influence upon efficiency of changes in blade area and form of blade; second, to determine the effect of modifications in pitch ratios. Most of the screws tried were four-bladed, 14·5 inches in diameter, with a blade area of 63 square inches—about 38 per cent. of the disc area. The pitch ratios varied from 1 to 2. An exhaustive analysis of the results has been prepared by Mr. Blechynden, and is worthy of study by every one interested in screw propulsion.* With this system of experiment the slip ratios could not be controlled as in the other experiments described, and they were excessive as compared with ordinary practice. Still, the efficiency curves based upon them closely resemble those obtained by Mr. Froude, are but slightly affected by changes in pitch ratio, and show nearly the same maximum efficiency.

From these model experiments certain broad deductions have been made. When any screw has a given slip ratio, its efficiency is unaltered by changes in revolutions and speed of advance. In symbols, if R_1 be the number of revolutions, and V_1 the speed of advance for a slip ratio s , and R_2, S_2 be greater or less values of revolution and speed of advance giving the same slip ratio—

$$\frac{R_2}{V_2} = \frac{R_1}{V_1}$$

$$R_2 = \frac{R_1}{V_1} \cdot V_2$$

* See vol. iii. (1886–1887) of the *Transactions* of the North-east Coast Institution of Engineers and Shipbuilders.

and the travel per revolution is unchanged. Mr. Froude has pointed out that under these circumstances the stream-line motions accompanying the screw action are unchanged in arrangement, but their speeds are varied in the ratio $V_2 : V_1$. All the forces acting on the screw blades will be varied in the square of that ratio; and since thrust and turning moment are similarly varied, while the travel per revolution is unchanged the efficiency remains constant.

By a similar train of reasoning it is shown that with a given slip ratio and given design of screw the efficiency is unaffected by changes in the size of the screw, if there be no variation in the coefficient of frictional resistance with increase in dimensions. In practice, when passing from models to full-sized screws there is the need for such a correction, and in a direction which favours increased efficiency in the larger screws. In order to obtain the same slip ratios, similar screws of different dimensions must work at different revolutions; these are termed "corresponding" revolutions, and the case is analogous to that of the corresponding speeds for ship models and full-sized ships.

"With a given slip ratio the thrust of a given screw," was found by Mr. Froude, "to vary as the square of the speed of advance through the water [in which it works]. With given slip ratio and given speed of advance, and with given design of screw and varying size, the thrust varies as the square of the dimension of the screw." The latter deduction is also liable to a correction for frictional resistance with varying size of screw and width of blade.

A single efficiency curve (such as CCC, Fig. 157) could be made to represent the conditions ascertained for all the screws tried by Mr. Froude, notwithstanding their different pitch ratios. But the slip ratios which gave maximum efficiency varied considerably with the pitch ratios. For example, when the pitch ratio was 1, maximum efficiency was obtained with about 16.5 slip ratio; when the pitch ratio was 1.7, with about 20 slip ratio; and when the pitch ratio was 2.4, with about 23.5 slip ratio.

The maximum efficiency obtained in all three series of experiments to which reference has been made was nearly the same, viz. about 0.7. All the curves of efficiency were very similar in form. Starting from the zero of thrust and slip, the ordinates rapidly increase with increase in slip ratio. For some distance before reaching maximum efficiency, and for a still greater distance beyond that point, increase in slip ratio is accompanied by a very slight change in efficiency. According to the curve given by Mr. Froude for a screw of 1.2 pitch ratio, the efficiency only varies by about .025 from the slip ratio of maximum efficiency 17.5 up to a slip ratio of 30. Mr. Blechynden gives a variation of nearly identical amount for a

screw of 1.25 pitch ratio over a range of slip ratio from 15 to 30. Mr. Thornycroft's curve of efficiency shows a more rapid decrease with increase of slip ratio, but it will be noted that his screw was of a different form, and with less proportionate blade area.

These discoveries as to the influence of changes in pitch ratio and slip ratio have a very important bearing upon the selection of a suitable propeller, showing that there is a considerable range of choice with practically constant efficiency. The late Mr. Froude, in the investigation mentioned on p. 608, fixed on a pitch ratio of about 2 as that which should give maximum efficiency; but general experience favours a more moderate pitch. He also recorded at the time (1878) the fact that experiments proved the efficiency to decrease but slowly with increase in slip up to as high a value as 30 per cent., and explained that with increasing slip a more or less pronounced eddy might be established at the back of the blades, thus neutralizing to a considerable extent the friction on that surface.

In regard to blade area and the effect of changes in the number of blades, there is less complete information, although many experiments have been made both with models and with actual screws. Four-bladed screws are most generally used—almost exclusively in the mercantile marine, and extensively in war-ships. Three-bladed screws have given excellent results also in war-ships. Two-bladed screws were formerly much used in single-screw ships with good sail power, in order that when the ships were under sail the screws might be fixed with blades vertical abaft the stern-post, and their "drag" diminished. Mangin screws four-bladed, but with one pair of blades set abaft the other, were used for the same reason. Now it may be said that only three or four blades need be considered; but there have been proposals to revert to a plan long ago experimented with, and to use six blades.

As regards the relative thrusts of propellers making a certain number of revolutions, having a given diameter, pitch, and shape of blade, but differing in the numbers of blades, there is experimental information from model experiments. With blades of elliptical form, Mr. R. E. Froude found the thrusts to be as 1 : 0.865 : 0.65 respectively for four, three, and two-bladed screws. With approximately rectangular blades, Mr. Blechynden found the corresponding values to be as 1 : 0.862 : 0.68. With other forms of blades the relative values varied somewhat, the thrusts on two and three bladed screws being proportionately less, but the variation had no practical importance so long as the pitch ratio was unaltered. With an increase in pitch ratio, the thrusts of the three and two bladed screws decreased somewhat in their proportion to the thrusts of a four-bladed screw.

Roughly, therefore, so far as these experiments are a guide, the respective thrusts may be assumed to be proportioned to the *square roots* of the blade areas, and not to the areas, when the numbers of blades are varied. This rough rule may require modification, and obviously does not apply as between blades of greatly differing form.

Further information is needed respecting the most suitable forms and areas of blades. The influence of width of blade upon thrust and frictional resistance requires to be investigated more thoroughly than has hitherto been done. At present the question is dealt with chiefly on the basis of comparison with past practice in ships whose performances have been recorded. The developed surfaces of the blades are expressed as a fraction of the area of the screw disc, and from 35 to 40 per cent. seems a common value for four-bladed screws. When diameter is limited by reason of moderate draught, proportionately larger width of blade and blade area are adopted.

From the series of experiments on model screws made by Messrs. Hawthorn, and the trials made on a steam-launch by Mr. Isherwood (mentioned on p. 542), Mr. Blechynden has made the following deductions, frictional and edge resistance being eliminated:—

1. In screws of equal diameter and pitch, but with different blade areas, when the same thrust is developed, the turning moment is independent of the blade area.

2. Screws of equal diameter and blade area, but varying pitch ratios, when tried under similar conditions and developing equal thrusts, have turning moments directly proportional to their pitch ratios.

3. Screws of varying diameters, but equal pitch ratios, developing equal thrusts, have turning moments proportional to their diameters.

4. In any screw, if the total blade area remains constant and the blades are similarly shaped, the propelling effect is the same, whether there are two or four blades.

The last deduction is based on Mr. Isherwood's experiments; Mr. Walker, whose experiments are mentioned on p. 614, does not admit that it is absolutely correct in all cases, although Mr. Isherwood found it to be so in the launch.

Although it is undoubted that changes in the forms, areas, and numbers of blades exercise but a moderate influence on efficiency of propulsion when compared with that of diameter, it is equally certain that the surface and shape of the blades do sensibly affect the results obtained. The case of the *Iris* is a striking illustration of the magnitude of the waste work which may result from excessive blade area and from certain forms of blades. Detailed calculations were made, with the best data then available for the probable screw friction. For full speed the following results were obtained:

With the original four-bladed screws, 1120 H.P. (*nett*) was expended on screw resistance at 91 revolutions; with the new four-bladed screws, only 420 H.P. at 97 revolutions; and with the two-bladed experimental screws, 330 H.P. As a rough estimate, suppose this nett horse-power to be increased 20 per cent. in order to approximate to the indicated horse-power. Then as between the original and the new four-bladed screws there would be a difference in waste work of about 850 I.H.P., representing over 11 per cent. on the total indicated horse-power. These figures are avowedly only approximations, but they indicate the importance attaching to the reduction of waste work on screws, and the use of the minimum blade area consistent with efficiency at sea, as well as in smooth water. Everything that favours smoothness of surface and diminished edgewise resistance is worth attention when designing and making screw blades. Considerable care has been bestowed upon these matters in recent years, and with advantageous results.

The main object of model experiments on screws is to obtain curves of thrust and efficiency which, by the laws of comparison above stated, can be applied to the determination of the diameter of a full-sized screw which shall maintain a given thrust when working behind a ship moving at a given speed, the screw making a certain number of revolutions per minute, and being as efficient as possible. If the model of the ship has been tested with a model screw behind it, then it may be assumed that the designer knows with close approximation the following particulars: effective horse-power for the speed; augmentation of resistance due to screw action, and thence the thrust horse-power; mean forward velocity of the wake in which the screw works, relatively to undisturbed water. Knowing the thrust necessary to maintain the speed, and having the curves of thrust and efficiency for model screws of differing pitch ratios, as well as the number of revolutions per minute proposed for the engines, it is possible to select a screw whose diameter and slip ratio will combine the required thrust and the nearest practicable approximation to maximum efficiency. Ordinarily, a designer would not possess such full information. He would have the approximate indicated horse-power required to give the intended speed to the vessel, and must obtain from the best sources available the probable "propulsive coefficient" (see p. 542), mean velocity of wake, and augment of resistance. By means of the propulsive coefficient the effective horse-power is estimated from the indicated horse-power, and the addition of the augment gives the thrust horse-power. The slip ratios must be estimated, of course, by allowing for the forward motion of the wake. Having thus approximated to the thrust, the remaining steps in the selection of the propeller are as described

above. If standard values for propulsive coefficients and wake are assumed, then it is possible to arrange the data obtained from model-screw experiments in a manner admitting of ready use with little labour. Various plans have been adopted for facilitating the work of selection. Mr. R. E. Froude has made the most comprehensive graphical arrangement; Mr. S. Barnaby has tabulated the data obtained by Mr. Froude in a very convenient form for practical use; Mr. Blechynden has devised another method which he considers preferable. It is impossible here to reproduce any of these methods, which will well repay study in the original publications above cited.

Each steam trial may be treated as a model experiment for guidance in designing other screws. Neglecting the variations which exist in the values of wake, augmentation, and propulsive coefficients in different types of ships; in other words, assuming that for the ships compared these features will be practically identical, it is possible to make the comparison in a very simple form.* Suppose the same pitch ratio and efficiency to be maintained, then—

(1) Disc area may be considered proportional to the indicated horse-power, and inversely proportional to the cube of the speed.

(2) Revolutions per minute may be considered proportional to the speed and inversely proportional to the diameter.

Let D_1, D_2 be the respective diameters of the two screws.

P_1, P_2 be the respective indicated horse-powers.

V_1, V_2 be the respective speeds of the two ships.

R_1, R_2 be the respective revolutions at these speeds.

Then from (1), since disc area is proportional to the square of the diameter—

$$D_1^2 \times \frac{V_1^3}{P_1} = D_2^2 \times \frac{V_2^3}{P_2}$$

$$\text{whence } D_2 = D_1 \sqrt{\left(\frac{V_1}{V_2}\right)^3 \times \frac{P_2}{P_1}} \quad \dots \quad (3)$$

From (2)—

$$R_1 \times \frac{D_1}{V_1} = R_2 \times \frac{D_2}{V_2} \quad \dots \quad (4)$$

$$R_2 = R_1 \times \frac{V_2}{V_1} \times \frac{D_1}{D_2}$$

The equations (3) and (4) may be useful in making comparisons, or recording trial data for future use.

* See Mr. S. Barnaby's "Marine Propellers" for examples.

CHAPTER XVII.

ESTIMATES FOR THE HORSE-POWER AND SPEED OF STEAMSHIPS—
STEAMSHIP EFFICIENCY.

IN designing new steamships, an approximation has to be made to the indicated horse-powers which will propel them at the stipulated speeds. The general practice is to base this approximation upon the actual performances of preceding ships, making use of recorded "coefficients of performance." Those "coefficients" are frequently based upon rules laid down in Admiralty practice at an early period in steamship construction, and they are consequently known as Admiralty coefficients. The formulæ for these coefficients are as follows:—

Let D = displacement of ship (in tons) at the draught of water on the trial; A = the corresponding area (in square feet) of the immersed midship section; V = speed (in knots) per hour; and P = indicated horse-power, then—

$$C_1(\text{midship-section coefficient}) = \frac{A \times V^3}{P}$$

$$C_2(\text{displacement coefficient}) = \frac{D^{\frac{2}{3}} \times V^3}{P}$$

In these expressions it is assumed: (1) that the resistance of the ship will vary as the *square* of the velocity, and the work to be done in propelling her as the *cube*; (2) that the useful or propelling effect of the engines, after allowing for the waste work to be done in overcoming frictional resistances, etc., of the machinery, and the waste work of the propeller, will vary as the indicated horse-power; (3) that for similar ships the resistances corresponding to any assigned speed will vary as the area of the immersed midship section, or the two-thirds power of the displacement.* The character of the first and last assumptions, and the limits within which they may be

* It may be interesting to state that the midship-section coefficient in their French naval architects generally use estimates for speed and power.

applied, have already been made the subject of comment in the preceding chapters. It has been shown that, so long as the speeds attained do not exceed the limits where wave-making resistance becomes important in proportion to frictional resistance, the law of the total resistance varying as the square of the speed holds fairly. Beyond that limit the law of variation ordinarily involves a higher power of the speed; although there are exceptions to this rule (see p. 472) when vessels are driven at very high speeds in proportion to their lengths. The second assumption also appears to hold fairly well with engines of similar and good design, and with any selected propeller of good proportions. It cannot, however, be applied without correction when the propellers of the two ships compared are of dissimilar character—one, say, a paddle, and the other a screw; nor can it be applied to all types of engines, the waste work being greater in some than in others. The greater the similarity in ship, engines, and propellers, the greater will be the degree of accuracy possible with this method of estimation.

With the foregoing limitations, the coefficients of performance furnish a good means of comparing the economy of propelling power in ships of similar form and proportions, and not very different sizes, as well as of estimating the probable power for a new ship. Of the two coefficients, that for the displacement is, on the whole, the more trustworthy, giving a fairer measure of the resistance than the midship-section coefficient, especially when dealing with ships which are not of exactly similar form.

As an example of the use of these coefficients, take the case of her Majesty's ship *Bellerophon*. On the measured mile, with a displacement of 7369 tons, a midship-sectional area of 1207 square feet, and an indicated power of 6312 H.P., she attained a speed of 14·053 knots per hour.

$$C_1 = \frac{1207 \times (14\cdot053)^3}{6312} = 531;$$

$$C_2 = \frac{(7369)^{\frac{2}{3}} \times (14\cdot053)^3}{6312} = 166.$$

The ship is 300 feet long, 56 feet broad, and had a mean draught of water, on trial, of $24\frac{1}{4}$ feet; hence her

$$\text{Coefficient of fineness}^* = \frac{7639 \times 35}{300 \times 56 \times 24\frac{1}{4}} = 0\cdot63.$$

When her Majesty's ship *Hercules* was designed, if the performances of the *Bellerophon* had been known, the engine-power required might

* See p. 3.

have been approximated to in the following manner: her length being 325 feet, breadth 59 feet, and mean draught $24\frac{2}{3}$ feet, her displacement was 8680 tons, and the area of midship section 1314 square feet. For these dimensions—

$$\text{Coefficient of fineness} = \frac{8680 \times 35}{325 \times 59 \times 24\frac{2}{3}} = 0.64,$$

or nearly the same as the fineness of the *Bellerophon*. It might have been assumed, therefore, that the *Hercules* would have coefficients of performance very nearly equal to those stated above. On trial the vessel attained 14.69 knots per hour; let this be taken as the designed speed, and let the corresponding horse-power be required. Using the midship-section coefficient 531—

$$\text{Probable I.H.P.} = \frac{1314 \times (14.69)^3}{531} = 7845 \text{ (nearly).}$$

Using the displacement coefficient 166—

$$\text{Probable I.H.P.} = \frac{(8680)^{\frac{2}{3}} \times (14.69)^3}{166} = 8065 \text{ (nearly).}$$

The actual indicated power required to drive the *Hercules* at the speed of 14.69 knots was rather more than 8520 H.P., or about 6 per cent. above the approximation from the displacement coefficient, and about 9 per cent. above that from the midship-section coefficient. The variation of the resistance at these speeds for ships of this type is known to depend upon some higher power of the speed than the square; and the naval architect would allow for this in his estimate, increasing the power somewhat above that given by the foregoing approximate method. In making this increase, he would be guided by the recorded performances of the exemplar ship at some less speed than the full speed; nearly all the vessels of the Royal Navy having been tried at reduced-boiler power as well as full power. For example, the *Bellerophon*, steaming at a speed of 12.15 knots, had a midship-section coefficient of 543 and a displacement coefficient of 171, as against 531 and 166 for a speed of 14.05 knots, indicating that the power required to drive the ship varied with a higher power than the cube of the speed. It really varied between those speeds as $V^{3.3}$; and if this correction is made for the *Hercules* in the preceding calculation, the probable indicated horse-power will rise to 8300, or within $2\frac{1}{2}$ per cent. of the power actually developed. To ensure the attainment of the speed desired, the naval architect would almost certainly provide some margin of indicated horse-power above that to which the approximate method conducts.

The difficult part of the work in practice lies in the selection

from available data of exemplar ships most nearly resembling the new design, in order that the appropriate coefficients may be obtained. In making this selection, it is necessary to compare carefully the fineness of form, the dimensions, the lengths of entrance and run in proportion to the maximum speeds, and some other particulars of the new ship and the completed ships; and to make allowances for greater or less fineness of form, differences in the frictional resistance, or any other matter affecting the speed under steam. In the Royal Navy, for many classes, little difficulty is experienced in discovering suitable examples; but when entirely new conditions are introduced, it is not possible to proceed with equal certainty, and then it becomes necessary, in proceeding by this comparative method, to allow a considerable margin of power for speed.

Take, for example, the *Devastation*, a vessel of very full form, moderate proportions of length to beam, and one of the earliest deep-draught twin-screw ships. It was estimated in designing this ship that with 5600 H.P. and a displacement of 9060 tons, a speed of at least $12\frac{1}{2}$ knots would be obtained; this would give a displacement coefficient—

$$C_z = \frac{(9060)^{\frac{2}{3}} \times (12\frac{1}{2})^3}{5600} = 151.$$

On the measured mile, with a displacement of 9190 tons, the ship steamed 11.91 knots with 3400 H.P., the displacement coefficient being 218; and at full speed she realized 13.84 knots with 6650 H.P., the corresponding coefficient being 175. Had the estimated power—5600 H.P.—been realized, the vessel would have steamed about 13 knots, that is, about $\frac{1}{2}$ knot faster than the estimated speed. Or, had she steamed $12\frac{1}{2}$ knots, the indicated horse-power required would have been 4000 H.P., instead of 5600 H.P., as estimated.

When the *Devastation* had been tried, and her coefficients determined, it was an easy matter to determine the appropriate engine-power for the succeeding deep-draught ships with twin-screws; and the superior performances of twin as compared with single screws rendered it possible to economize engine power. This was done; and in the *Alexandra*, *Temeraire*, and other vessels, the engines were made less powerful and weighty than they would have been with single screws. Subsequent trials fully justified this procedure. Take, for example, the *Alexandra*. It was estimated that 8000 H.P. would suffice to drive the ship about $14\frac{1}{2}$ knots, when fully laden and weighing 9500 tons. On the measured mile the speed of 15 knots was attained, and the engines exerted 8600 H.P., 600 H.P. more than the guaranteed power. When allowance is made for this excess of power, it appears from calculation that the fully laden ship would

have exceeded the upper limit of her intended speed with 8000 H.P. Had she been fitted with a single screw, instead of twin-screws, at least 500 or 600 H.P. additional would have been required to attain the same speed.

Another method of approximation which has been largely used consists in the determination of the ratio of the indicated horse-power to the wetted surface in the exemplar ship or ships at the trial speeds; and the estimate from this ratio of the probable value of the corresponding ratio for the new ship at her designed speed. This method of procedure will be seen to correspond to that described for sailing ships on p. 514. It can be safely used when the speeds considered are moderate in proportion to the dimensions; for which speeds the resistance of the new ship, as well as those of the exemplar ships, vary nearly as surfaces and the squares of the speeds. From the remarks made on the surface friction of ship-shaped forms on p. 451, it will appear that larger differences of form, within the stated limits of speed, can probably be dealt with by this method than by the use of the "Admiralty coefficients." For higher speeds where wave-making resistance assumes relative importance, neither the wetted surface ratio nor the Admiralty coefficients can be applied without correction of the kind indicated above.

The late Professor Rankine proposed a method for computing the probable speed and power of steamships closely resembling that just described. Assuming that the speeds were kept within the limits for which the resistance varied sensibly as the square of the speed, Rankine approximated to the resistance by means of the "augmented surface" described on p. 452. The nett resistance of the hull in well-formed ships with clean bottoms he thought might be expressed in the form—

$$\text{Nett resistance (in pounds)} = \frac{\text{augmented surface (in square feet)} \times \text{speed of ship (in knots)}^2}{100}.$$

The ratio of the "effective horse-power" (estimated from the nett resistance) to the indicated horse-power, he assumed to be 1 : 1.63; and thence obtained as a final approximate rule for practice:—

$$\text{Probable I.H.P.} = \frac{\text{augmented surface} \times (\text{speed in knots})^3}{20,000}$$

This divisor was termed the "coefficient of propulsion," and its value might vary considerably in different ships with differences in the roughness of the bottom, the efficiency of the engines and propellers, or defects of form. In some cases it was found to be as low as 16,000. The remarks made above as to the use of the wetted surface apply here also. Either method, depending as it does upon

the assumption that the resistance varies as the square of the speed, fails to include a very large number of the cases occurring in practice; and Rankine's coefficient of propulsion, like the Admiralty coefficients, rarely has a constant value for a large range of speed in the same ship. Moreover, on the basis of the experiments made by Mr. Froude, it may be questioned whether the computation of the augmented surface is to be preferred to that of the wetted surface, even for estimates of surface friction. As a provisional theory, this of Rankine's was valuable; but subsequent experiments with ships and models have practically superseded it.

Attention must next be directed to the very valuable assistance in speed-calculations derivable from *progressive steam-trials*; that is to say, the trial of the same ship at several different speeds, and the determination of the horse-power, and other particulars for each speed. Trials of this kind have been made occasionally with ships of the Royal Navy for a long time past, and in recent years examples of most of the types introduced have been tried progressively. As early examples of progressive trials, made for special purposes, we may refer to the trials made with the *Flying Fish* in 1856, to test different kinds of propellers and forms of bow; those made on her Majesty's yacht *Victoria and Albert* in 1855-56; and those made on the *Warrior* in 1861. In the case of the *Victoria and Albert*, the trials were very exhaustive, and the curve of horse-power corresponding to various speeds (see Fig. 161) was constructed. Outside the Royal Navy also such trials were occasionally made. Mr. Isherwood, in 1869, tried the steam launch, to which many references have been made, progressively; and determined the power, revolutions and slip of screw, mean pressure, etc., for a large number of speeds, in order that he might construct curves for all these features of the performance. Mr. Thornycroft did very similar work at an early date for some of the small swift vessels built by him.* These progressive trials were, however, exceptional, up to 1870; since which date they have been commonly carried out for merchant ships and war-ships with great advantage. This change of practice and development of progressive trials is to be attributed largely to the action of the late Mr. W. Denny (of Dumbarton), whose firm took the lead in this movement, and greatly assisted its progress by the publication of a large amount of valuable information obtained on trials of ships built by them.† An example of the ordinary method

* See *Transactions* of the Institution of Naval Architects for 1869 and 1872.

† See papers by Mr. W. Denny contributed to the *Proceedings* of the Institution of Engineers and Ship-builders in Scotland for 1875; and to the British Association for the same year.

of recording these trials is given in Fig. 160, and represents the performance of a very successful steamer built by Messrs. A. and J. Inglis of Glasgow. Abscissæ measurements on the base-line represent speeds in knots per hour. The curve A A A represents, by

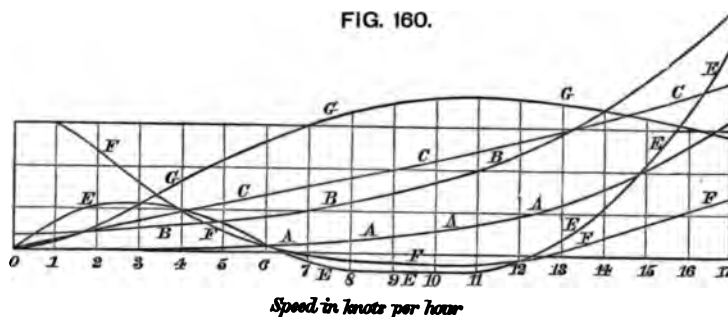

References.

- A A A— Curve of indicated horse-power.
- B B B— " " thrust.
- C C C— " " revolutions of screw.
- E E E— " " slip of screw (apparent).
- F F F— " " slip of screw, expressed as percentage of its speed.
- G G G— " " coefficients of performance.

its ordinate measurements, the variation of the indicated horse-power with the speed ; it was drawn through points determined by trials made at a series of four or five speeds between 8 knots and 15½ knots. The curve B B B represents, by its ordinates, the variation of the "indicated thrust" with variations of the speed. The curve is obtained from the curve A A A taken in connection with the curve C C C which represents, by its ordinates, the variation of the revolutions of the screw with the speed, these revolutions being counted for each trial speed, and the curve C C C being drawn through the points thus obtained. Since the indicated thrust equals the fraction

$$\frac{33,000 \times \text{I.H.P.}}{\text{pitch of screw} \times \text{revolutions per minute}}$$

while the indicated horse-power is expressed by the product (see p. 538).

Mean piston pressure × stroke × revolutions,

it is obvious that the curve B B B, by its ordinates, represents "mean piston pressure" for any speed as well as "indicated thrust," the scales being different in the two cases. At the zero of speed there is an ordinate value for the curve B B B ; this represents the

"constant friction" (see p. 544). The curve E E E represents the apparent slip of the screw in knots, and F F F the percentage of slip; these are obtained from the curve C C C, the pitch of the screw being given. Another curve G G G also appears, its ordinates being proportional to the quotient of the cube of the speed by the indicated horse-power; it is derived from curve A A A. This curve G G G is termed the "curve of coefficients," and its ordinates can obviously be made to represent, by suitable scales, both the Admiralty coefficients and Rankine's coefficient of propulsion. Were these coefficients really "constants," the curve of coefficients would become a straight line parallel to the base-line.

With graphic records of progressive trials before him, the designer of new ships of similar form and type can proceed with greater assurance of success than is attainable with less extensive information. If a ship of practically identical form and size, but less speed, is to be built, his task is simply one of measurement from the curves with some slight correction for difference in constant friction. If the speed of such a ship is to be greater than that of her predecessor, it is also possible to make a close approximation—provided that the excess in speed is not very considerable—from an inspection of the curves of indicated horse-power and coefficients. When the sizes and speeds of ships are both varied, but approximately similar forms are maintained, the problem is more complicated, but still it can be dealt with approximately, by an application of Mr. Froude's law of "corresponding speeds" explained on p. 480.*

Supposing that from the graphic record of the results obtained on a progressive trial, the constant friction of the engines has been determined, and then eliminated from the indicated thrust by drawing a line parallel to the base-line through the point where the original curve of indicated thrust (B B B, Fig. 160) cuts the ordinate of the zero speed. The line so drawn forms a new base-line giving the indicated thrusts and mean piston pressures, excluding constant friction; and the corresponding corrected indicated horse-power curve can be con-

* The late Mr. Froude indicated this application in a paper on "Useful Displacement" contributed to the *Transactions* of the Institution of Naval Architects in 1874. The author had also applied it commonly in his professional work for sometime before the publication of the first edition of this book (1877), and therein gave an illustration of the method. Mr. John Inglis was led to the same practice by a study of Mr.

Froude's writings, and contributed a valuable paper on the subject to the *Transactions* of the Institution of Naval Architects in 1877. An interesting graphic method of dealing with the subject will be found in a paper contributed by Mr. Young to the *Transactions* of the North-East Coast Institution of Engineers and Shipbuilders for 1892-93 (vol. ix.).

structed. In what follows we shall speak of these corrected curves, and of the derived curve of coefficients.

Next let it be assumed, although not strictly nor necessarily true, that the corrected indicated thrust bears a constant ratio to the nett resistance at any speed. For any speed V_1 of a ship that has been tried, let T_1 = the corrected thrust (or mean pressure) and P_1 = the corresponding horse-power. Then, with the foregoing assumptions, if we increased the lineal dimensions of the ship D times, and towed the larger ship at a speed of $V_1\sqrt{D}$, her resistance at that speed (or indicated thrust) would be expressible in the form—

$$T_2 = T_1 \cdot D^3,$$

and the corresponding horse-power would be—

$$P_2 = T_2 \times V_1\sqrt{D} \times \text{a constant},$$

while $P_1 = T_1 \times V_1 \times \text{the same constant}.$

Hence—

$$\frac{P_2}{P_1} = \frac{T_2}{T_1} \cdot \sqrt{D} = D^{\frac{7}{2}}$$

This is an expression from which the horse-power for the larger ship can be found for a speed $V_1\sqrt{D}$, when that for the exemplar ship has been ascertained from the progressive trials at speed V_1 . To the value of P_2 , thus determined, must be added the assigned percentage for constant friction, of which particulars are given on p. 544, in order to find the indicated horse-power required for the speed ($V_1\sqrt{D}$). In this manner not merely the power for full speed can be estimated approximately, but that for any other speed, and so a new curve of indicated horse-power can be drawn for the new ship. This could not be done, it will be seen, unless curves such as those in Fig. 160 were available; and they are therefore of great value. If the difference in size is considerable between the two ships, it may be necessary to deal with the frictional resistance separately, and to apply the foregoing rules to the wave-making resistance only; but this kind of correction is not usually made.

Using the same notation as before, another deduction may be made from the foregoing investigation. Suppose the coefficient of performance curve for the exemplar vessel to be drawn from the equation—

$$\text{Coefficient} = \frac{\text{speed}^3 \times \text{area of midship section}}{\text{indicated horse-power}}$$

Let A_1 = area of midship section in smaller vessel; A_2 = corresponding area in larger vessel; then obviously $A_2 = D^2 \cdot A_1$.

Also, the following values will hold good :—

$$C_1 = \text{coefficient for smaller vessel at speed } V = \frac{V^3 \times A_1}{P_1}$$

$$C_2 = \text{coefficient for larger vessel at speed } V\sqrt{D} = \frac{V^3 \times D^{\frac{3}{2}} \times A_2}{P_2}$$

$$\therefore \frac{C_1}{C_2} = \frac{A_1}{A_2} \frac{P_2}{P_1} \cdot \frac{1}{D^{\frac{3}{2}}} = \frac{A_1}{D^2 A_2} \times \frac{P_2 \cdot D^{\frac{7}{2}}}{P_1 \cdot D^{\frac{3}{2}}} = 1$$

That is to say, with the preceding assumptions, the coefficients of performance for two similar vessels steaming at “corresponding speeds” are identical. This statement holds good for the Admiralty coefficients as well as for Rankine’s coefficient of propulsion. In practice it may be modified by some departure from the assumptions; but the broad deduction is useful for practical purposes in comparing efficiencies of vessels similar in form and method of propulsion, but unequal in size.

From this investigation it follows that for two ships of unequal size, but similar form and similarly propelled, driven at the *same speed*, the larger will have the higher coefficient of performance; the indicated horse-powers usually increasing at a more rapid rate than the cube of the speed.

In applying the results of progressive trials to speed calculations, care is required to secure, if possible, similar conditions in the exemplar ship and the new design as regards not merely form, but type of engine and propeller, and equal smoothness of bottom. Differences in the coefficient of friction, arising either from different degrees of roughness or greatly different lengths of ships (see p. 443), must be allowed for; and this can be done without difficulty, if desired, in comparing small ships with large. In fact, to secure the closest approximation to the horse-power in a new ship, every part of the work requires to be done with scrupulous care and intelligence. For rough estimates, on the other hand, some of the foregoing corrections may be omitted; and more especially the correction for constant friction of engines when approximating to the indicated horse-power for full speeds.

One example may be given of the approximate formulæ based on corresponding speeds. We will choose her Majesty’s ships *Hercules* and *Greyhound*, which are very similar in form, but different in size, speed, and character of bottom.

The similarity of the forms will appear from comparing the ratios of the lengths, breadths, draughts, and cube roots of the displace-

ments given in the Table below. Using the letter D to express this ratio, we have—

$$D = \sqrt[3]{\frac{8676}{1157}} = 1.957;$$

$$\sqrt{D} = \sqrt{1.957} = 1.4 \text{ (nearly).}$$

On trial, the *Hercules* attained a speed of 14.69 knots.

$$\left. \begin{array}{l} \text{Corresponding speed} \\ \text{for } \textit{Greyhound} \end{array} \right\} = \frac{14.69}{\sqrt{D}} = \frac{14.69}{1.4} = 10.5 \text{ knots (nearly).}$$

On trial, the *Greyhound* attained a maximum speed of 10.04 knots with 786 I.H.P.; at that speed her resistance was varying about as the *cube* of the velocity, and therefore the horse-power would vary as the fourth power. Hence—

$$\left. \begin{array}{l} \text{Indicated horse-power for} \\ \text{speed of 10.5 knots} \end{array} \right\} = 786 \times \left(\frac{10.5}{10.04}\right)^4 = 940 \text{ H.P.}$$

Ships.	Length.	Breadth.	Mean draught.	Displacement on trial.
<i>Hercules</i> . . .	feet. 325	feet. 59	feet. 24.6	tons. 8676
<i>Greyhound</i> . .	172½	33½	13.7	1157

The thrust of the propeller in the *Greyhound* at 10.5 knots might therefore be considered proportional to the quotient $940 \div 10.5$; if for the *Hercules* at 14.69 knots a corresponding assumption is made, and the thrust considered to be the same proportion of the quotient of the required indicated horse-power (P, say) $\div 14.69$. In both ships the engines would be working at full speed; and for our present purpose it may be assumed that the thrusts would be proportioned to the resistances of the two ships. Using the law of comparison proposed by Mr. Froude—

$$\left. \begin{array}{l} \text{Resistance for } \textit{Hercules} \\ \text{at 14.69 knots} \end{array} \right\} = (1.957)^3 \times \left\{ \begin{array}{l} \text{resistance for } \textit{Greyhound} \\ \text{at 10.5 knots.} \end{array} \right.$$

$$= 7.5 \times \left\{ \begin{array}{l} \text{resistance for } \textit{Greyhound} \\ \text{at 10.5 knots.} \end{array} \right.$$

Hence, approximately—

$$\frac{\text{I.H.P. for } \textit{Hercules} \text{ at 14.69 knots}}{14.69} = \frac{7.5 \times 940}{10.5}$$

$$\text{I.H.P. for } \textit{Hercules} \text{ at 14.69 knots} = 9870 \text{ H.P.}$$

This power is largely in excess of that actually developed in the *Hercules*, when she attained a speed of 14.69 knots; but it must

be remembered that in the calculation the same coefficient of friction has been assumed for the *Hercules* as for the *Greyhound*; whereas the *Hercules* was tried with a cleanly coated iron bottom, and the *Greyhound* with a copper bottom somewhat deteriorated by age. A correction is therefore necessary, and it may be simply made.

It has been estimated that for a speed of 600 feet per minute the coefficient of friction for the bottom of the *Greyhound* was about 0.325 lb. per square foot of surface, as against 0.25 lb. for a cleanly painted iron bottom; and this difference would involve an increase of between *one-seventh* and *one-eighth* in the total resistance and indicated horse-power for the speed of 10.5 knots. In other words, if the *Greyhound*, instead of being tried with her worn copper, had been tried with a cleanly coated iron bottom, like that of the *Hercules*, the speed of 10.5 knots would probably have been attained with about 830 H.P., instead of 940 H.P. Making this correction in the foregoing equation, we have, approximately—

$$\begin{aligned} \text{I.H.P. for } \textit{Hercules} \text{ at } 14.69 \text{ knots} &= \frac{7.5 \times 14.69 \times 830}{10.5} \\ &= 8715 \text{ H.P.} \end{aligned}$$

This is a close approximation to the actual power (8529 H.P.) which was developed on the measured-mile trial of the *Hercules*; but the same degree of accuracy may not always be secured in estimates made in this manner.

The foregoing methods of approximation are all in common use by shipbuilders and marine engineers, and there are others of undoubted value to which limits of space prevent even a passing reference.* Valuable as these methods are in ordinary practice, they do not compare in accuracy or trustworthiness with the method of model experiment devised by the late Mr. Froude. Twenty years' experience in the designing of ships for the Royal Navy, covering a period during which unprecedented speeds have been attained, and many new types of ships and machinery have been introduced, have placed the value of this method beyond doubt. Less extended experience of the model-experimental system outside the Admiralty service, both at home and abroad, has confirmed this conclusion. The full descriptions given in preceding pages have indicated how the problems of nett resistance, screw efficiency, augmentation of

* See the reports of the British Association Committee on Steamship Performance; papers by Mr. Thornycroft and the late Mr. Kirk in the *Transactions* of the Institution of Naval

Architects for 1869 and 1880; and numerous papers by Mr. Robert Mansel in the *Proceedings* of the Institution of Engineers and Shipbuilders in Scotland, as well as in other publications.

resistance, and propulsive coefficients have been dealt with experimentally by means of models and the trials of actual ships; while the efficiency of the mechanism in marine engines has also received investigation. When novel problems in propulsion have to be solved, or unusual forms of ships built for special services, or speeds attempted which lie much outside experience, the designer, aided by model experiments made at small cost, can proceed with greater certainty of success. As specimen cases, reference may be made to the imperial Russian yacht *Livadia*, the form of which was quite novel. The late Dr. Tideman made trials on the tow-rope resistances of a model; these were supplemented by an interesting series of trials on a large scale model, propelled by its own screws; and in the actual ship the performances under steam substantially confirmed the estimates based on the models. Again, in the *Inflexible* of the Royal Navy, where the form was of a novel character, and the breadth extreme was unusually large in relation to length and draught, the estimates for engine-power based on model experiments were closely verified on the measured-mile trials. Many other striking examples might be given, but they are scarcely required.

STEAMSHIP EFFICIENCY.

The subject of steamship efficiency has occupied much attention, and several standards of comparison have been proposed. None of these standards can be employed universally, however, in the comparison of different types of ships; because in many types, and more especially in ships of war, the choice of forms and proportions is largely influenced by other considerations than those relating to *economical propulsion*. It is unnecessary to repeat the remarks already made on this point, although their importance is frequently overlooked; no distinction being made between the ideal conditions of forms of least resistance, propellers of maximum efficiency, and engines of perfect construction, and the conditions of practice with all their limitations or restrictions. Bearing this distinction in mind, we now proceed to summarize the circumstances which chiefly influence economy of steam-power.

For any selected form and type of ship, economical propulsion is favoured by *increase in size*. This is readily illustrated if the speeds are assumed to fall within the limit where the resistance varies as the square of the speed.

Suppose two similar ships to be compared, the weight of one being W_1 and that of the other W_2 . Let D be the ratio which the length or any other dimension in the larger ship bears to the corresponding dimension in the other. Then it must follow that—

$$W_1 = D^3 \cdot W_2,$$

the weight increasing with the *cube* of the ratio of corresponding dimensions. On the other hand (as explained at p. 480), the resistances will bear to one another the ratio of the *two-thirds* power of the displacement; and if R_1, R_2 represent the resistances—

$$\frac{R_1}{R_2} = \left(\frac{W_1}{W_2}\right)^{\frac{2}{3}} = D^2 = \frac{1}{D} \times \frac{W_1}{W_2}$$

the resistance increasing only with the *square* of the ratio of corresponding dimensions. For instance a ship *twice* as long, *twice* as broad, and *twice* as deep as another will have *eight* times as great displacement, but when moving at the same speed, will experience only *four* times the resistance, and require only *four* times the engine-power. The longer ship would require to have heavier scantlings than the smaller; and consequently the hull might be somewhat heavier in proportion to the displacement. But even supposing this greater proportionate weight of hull were incurred, the larger ship would be far more economical of steam-power in proportion to the dead weights carried.

Irrespective of any assumed law of resistance, it is possible in general terms to indicate the economy of propulsion obtained by increase in size. Using the same notation as before, let the two ships compared be supposed moving at the speed V , their resistances, excluding the frictional resistances on the bottoms, being R_1 and R_2 . Let R be the resistance of the smaller vessel when moving at the speed $V \div \sqrt{D}$; and let it be supposed that between this speed and the speed V the resistance varies with some unknown power ($2n$) of the speed. Then—

$$\frac{R}{R_2} = \left(\frac{V}{\sqrt{D}}\right)^{2n} \times \frac{1}{V^{2n}} = \frac{1}{D^n}; \text{ whence } R = \frac{R_2}{D^n}$$

Also, by the law of comparison—

$$R_1 \text{ (for large ship)} = D^3 \times R = D^{3-n} \cdot R_2,$$

$$\frac{R_1}{R_2} = a = D^{3-n};$$

and, as before—

$$W_1 \text{ (for large ship)} = D^3 \cdot W_2; \text{ whence } \frac{W_1}{W_2} = b = D^3;$$

so that finally, for equal speeds of two similar ships—

$$\frac{1}{D^n} \cdot \frac{W_1}{W_2} = \frac{R_1}{R_2}; \text{ or } \frac{a}{b} = \frac{1}{D^n}$$

The greater the value of n for a certain value of D , the less will be the ratio $a : b$ measuring the ratio of the increased resistance,

involved in enlarging the ship, to the corresponding increase in displacement and carrying power. If the resistance between the speeds V and $V \div \sqrt{D}$ varies as the *square* of the speed, $n=1$, and the final equation assumes the form—

$$\frac{1}{D} \cdot \frac{W_1}{W_2} = \frac{R_1}{R_2}$$

agreeing with the result previously obtained for that law of variation. But if the resistance between the speeds V and $V \div \sqrt{D}$ varied as the *fourth* power of the speed, then $n=2$, and we have—

$$\frac{1}{D^2} \cdot \frac{W_1}{W_2} = \frac{R_1}{R_2}$$

If the resistance of the smaller vessel between the speeds V and $V \div \sqrt{D}$ varies as the *sixth* power of the speed, then $n=3$: and

$$\frac{1}{D^3} \cdot \frac{W_1}{W_2} = 1 = \frac{R_1}{R_2}$$

that is to say, the small ship would experience as great a resistance at the speed V as the larger ship of similar form if the foregoing assumptions held good. As a matter of fact, however, whatever may be the law of variation in the wave-making resistance in terms of the speed, the frictional resistance does not vary more rapidly than the square of the speed, and this would make the resistance of the smaller vessel less than that of the larger.* It is easy to make the necessary correction for friction in the manner explained on p. 451.

The comparison of the *Merkara* and *Greyhound* types will furnish a good illustration of the foregoing equations. At 12 knots, for the *Merkara*, n may be taken as *unity*, and for the *Greyhound* as 2 nearly; in both ships $R=20,000$ lbs. Suppose both vessels to have their lengths and other dimensions increased by one-third; then $D=1\frac{1}{3}$. The *Merkara* has a displacement of 3980 tons; the *Greyhound* one of 1160 tons; the enlarged *Merkara* would weigh 9430 tons, the enlarged *Greyhound* about 2750 tons.

$$\text{For enlarged } \textit{Merkara}, R_1 = 20,000 \times \left(\frac{4}{3}\right)^2 = 35,555 \text{ lbs.}$$

$$\text{For enlarged } \textit{Greyhound}, R_1 = 20,000 \times \frac{4}{3} = 26,666 \text{ lbs.}$$

The *Greyhound* type, therefore, gains more in economy of propulsion

* For interesting graphic illustrations of the above equations, see a paper by Mr. Biles in the *Transactions* of the Institution of Naval Architects for 1881.

by enlargement than does the *Merkara*; although the latter type benefits considerably by the same process, and would have much greater carrying power in proportion to the expenditure of fuel as the size increased.

To the foregoing considerations, which have had regard only to smooth-water performances, it is necessary to add one remark. In ocean steaming, the longer, larger, heavier ship is far more likely to maintain her speed under varying circumstances of wind and sea than is the smaller vessel. These two sources of gain in larger ships fully explain the general adoption of the policy which has resulted in very large increase of the sizes of ocean steamers.

Increase in size and variation in proportion may, as explained in Chapter X., affect the ratio which the weight of hull bears to the displacement. No general law can be stated for this ratio; but for purposes of illustration let it be supposed that the longer, larger vessel has a relatively heavier hull. This increase in weight of hull must be set against the proportionate saving on propelling apparatus and coal. But the balance of advantage in a commercial sense on long voyages would still remain with the larger ship when the difference in size is considerable. As an example take the *Merkara* and the enlarged *Merkara* mentioned above. If 1600 H.P. was required to drive the *Merkara* 12 knots, about 2800 H.P. would suffice for the latter. For voyages of equal length at that speed the weights of coal burnt would bear to one another the same ratio as the horse-powers. Take 400 tons for the weight of engines, etc., for the smaller ship; then 700 tons will be about the corresponding weight for the larger ship; if the *Merkara* be credited with a coal supply of 500 tons, the larger ship should carry about 880 tons. Suppose, further, that in the *Merkara* the hull weighed about 33 per cent. of the displacement, whereas in the larger ship it was increased to 40 per cent.; then in the *Merkara* there would remain 1800 tons available for cargo and equipment, which could be propelled over a certain distance by an expenditure of 500 tons of coal, as against 4100 tons in the large ship, which would require an expenditure of less than 900 tons of coal for an equal distance.

In the former case the expenditure of 1 ton of coal would carry 3.6 tons of cargo over the distance, and in the larger ship an equal consumption would carry about 4.5 tons, or an increase of 25 per cent. From the commercial side the gain in dead-weight capacity would represent a large increase in earning power, accompanied of course by a considerably increased first cost, and greater working expenses. Into these matters it is not proposed to enter here; but the fact that the balance of advantage lies considerably on the side of the larger vessel is undoubted. The figures given above, it will be

understood, are simply for purposes of illustration; but they do not err on the side of favouring the larger vessel.

Increase in size is found to be accompanied by equal economy in power when war-ships are compared. For example, a vessel of the *Admiral* class, 325 feet long, 68 feet broad, with a displacement of 10,000 tons, requires about 5000 H.P. for a speed of 14 knots in smooth water, whereas for the same speed about 6400 H.P. suffices to drive the *Royal Sovereign*, of 14,200 tons displacement, 380 feet in length, and 75 feet in beam. In both cases the ships are well formed, the engines are vertical and applied to twin-screws. Although the *Royal Sovereign* has triple-expansion engines, while the *Admiral* has compound engines, the losses on friction are probably nearly the same in both cases. At higher speeds the larger ship gains upon the smaller. For example, about 12,000 H.P. would be required for 17 knots in the *Admiral*, whereas the *Royal Sovereign* attained 16.77 knots on the measured mile with 9760 H.P., and would require less than 10,500 H.P. for 17 knots, or absolutely less power than the shorter and smaller ship. Weight of propelling machinery and rate of coal expenditure being dependent upon the indicated horse-power, it will be obvious how great is the gain in weight disposable in armour, armament, and equipment by adopting larger dimensions.

Economical propulsion is also greatly promoted by the adoption of forms and proportions, in association with a given displacement, which lead to *diminished resistance*. This may seem a mere truism, but it is desirable to give one or two illustrations of the extent to which economy may be carried. For this purpose recourse may be had to the steam trials of ships, although it is necessary to observe that in these results the relative efficiencies of propellers and machinery are influential as well as differences of form. The table on p. 642 is of interest, as indicating the horse-power required to give a smooth-water speed of 14 knots to certain typical war-ships of approximately the same displacement but varying dimensions and forms. The first two vessels are single screw, and their maximum speeds were between 14 and 15 knots, so that their engines were working under very favourable conditions near their maximum powers at 14 knots. The other two are twin-screw, and their engines were only developing about one-third and one-fifth respectively of the maximum powers when the ships were steaming 14 knots. Consequently they were not working under such advantageous conditions.

The table furnishes an illustration of what may be done, with a practically constant length and draught, in the direction of economizing power by changes in form. Comparing, for example, the *Warrior* and *Blake*, a decrease in power of 20 per cent. is associated with an increase in beam of 7 feet, and a slight decrease

in draught. Again, as between the *Hercules* and ship of the *Admiral* class, there is an economy of about 38 per cent., associated with an increase in beam of 9 feet and in draught of a few inches. The greater breadths in the later ships are only amidships, and at

Ship.	Length.	Breadth.	Mean draught.	Displacement.	Indicated horse-power for 14 knots.
	ft.	ft.	ft. in.		
<i>Warrior</i>	380	58	26 0	8850	5000
<i>Hercules</i>	325	59	24 8	8675	7250
<i>Admiral</i> class	325	68	25 3	8900	4500
<i>Blake</i>	375	65	25 9	9100	4000

the extremities finer forms are thus made possible. At p. 464 the gain in economy of power resulting from this change of form has been explained. Twin-screws in the modern vessels have also favoured economical propulsion.

As between war-ships and merchant ships, built as they are to fulfil widely different conditions of service, and having radically different vertical distributions of their weights, comparisons of the expenditures of power at equal speeds have little practical value. Speaking broadly, the merchant steamer is longer and narrower for a given displacement than the war-ship. Her length is greater in relation to the maximum speed attained. As a rule, therefore, for equal speeds and displacements the merchant ship requires a less expenditure of power for reasons which have been explained above. It is unnecessary to repeat those explanations, or to dwell upon the much greater importance of handiness and manœuvring power in the war-ship.

The question of *protection* has an important influence on the most suitable forms and proportions in war-ships. The designer has to consider not only what expenditure of power will be required with given dimensions at the intended speed, but what weight of protective material—vertical or deck armour—will be needed with those dimensions. It may, and does often, happen that the best results in point of cost and efficiency are obtained by choosing dimensions and forms less economical in engine-power and coal consumption, but which tend to minimize the weight and cost of armour.

In the earlier periods of the armour-clad construction, when the whole length at the water-line was protected, either by a belt of considerable depth or by armour carried to the height of the upper deck, this matter was of great importance. Sir Edward Reed

discussed it exhaustively when Chief Constructor of the Navy, and one case may be taken as an illustration. Taking the ironclad frigate *Hercules* as a type, an estimate was made of the dimensions and cost of a vessel which should carry the same battery and guns, the same armour protection on the water-line belt, have the same speed and coal supply, and be built on the same system; the new ship was to have the same proportion of length to breadth as the *Minotaur*, and to be equally economical of steam-power. The following tabular statement shows the result of careful calculations:—

Particulars.	New ship (as estimated).	<i>Hercules</i> .
Length (in feet)	385	325
Breadth (in feet)	57½	59
Displacement (tons)	9088	8676
Weight (in tons) of—		
Hull	4574	4022
Armour and backing on belt	1518	1292
" " " on batteries	398	398
Engines, boilers, and coals	1460	1826
Equipment and armament	1138	1138
Indicated horse-power for speed of 14·69 knots	6585	8529
First cost of—	£	£
Hull } at average prices for ironclads	{ 326,500	287,400
Engines } built prior to 1869	{ 55,500	72,000

After crediting the long ship with less powerful and costly engines, it appears that the total cost of the *Hercules* for hull and engines would be about £22,000 less. The more powerful engines of the *Hercules* would undoubtedly be more expensive to keep at work, owing to their greater consumption of fuel; but “the interest at a low rate on the difference of prime cost would quite make up for the additional cost of fuel in the *Hercules*, supposing her to be in commission and on general service.” The longer and larger ship, moreover, would be more costly to man and maintain in repair; and her rate of turning would be slower as compared with the *Hercules*.

When the “central-citadel” system was introduced in the *Inflexible*, another consideration had an important influence upon form and proportions: viz. the provision of stability when the ends were riddled (see p. 134). A less ratio of length to breadth was adopted than in any preceding ironclads of equal speed, and much greater fineness was given to the extremities. These changes in form, as a matter of fact, proved aids to economical propulsion, and the measured-mile performances of the *Inflexible* with her ratio of length to breadth (4½ to 1) compared favourably with those of other vessels of equal length, greater draught, and having ratios of length

to breadth of 5 or $5\frac{1}{2}$ to 1. At 14 knots the "displacement coefficient" of the *Inflexible* was nearly 190, which is about the same as that obtained with the *Alexandra* of equal length, over 11 feet less beam, and nearly 2 feet greater draught, with 2000 tons less displacement.

It is possible, of course, to carry too far restriction in length and increased fulness of form. In economizing on weight of hull and protective material, forms and proportions may be adopted which most seriously and to an unwise extent cripple efficiency of propulsion. The extreme case of the Russian circular ironclads will illustrate this statement. They were designed for coast-defence service in the shallow waters of the Black Sea, and the circular form was chosen because it gave the least surface and the greatest carrying power in proportion to displacement. If the vessels had been mere floating forts, this view would have been correct. But passing from stationary flotation to the case of locomotion at moderate speeds, the circular form is found to be most unsuitable. Model experiments and the actual performances of the ships show that a circular ship of the cross-sectional form adopted by the Russian designers experienced about *five times* as great resistance as a ship like the *Devastation* when moving at equal speed. It is probable that by changes in cross-sectional form the resistance might be reduced; but for purposes of illustration we will take the Russian form, and show what would be its influence upon size if a circular ship were built to steam as fast and as far as the *Devastation*, both ships being fitted with the same types of machinery and boilers—say the compound type used about 1870 (see p. 564), and carrying the same dead weight of armour, armament, and equipment. Using for the *Devastation* the ascertained weights for the ship as built, with suitable changes on account of compound engines instead of the low-pressure surface condenser type with which she was originally fitted, and using for the circular ship *data* furnished by the advocates of that type, the comparative results for the *Devastation's* maximum speed of about $13\frac{3}{4}$ knots are given in the table on the following page.*

If the proportions of the existing ships were followed, this vessel would be about 230 feet in diameter, and $19\frac{1}{2}$ feet draught. The circumference at the water-line would be about 720 feet; whereas the total length of the water-line requiring to be armoured in the *Devastation* would not exceed 640 feet; and consequently an armour belt of equal depth and thickness on the two ships would weigh

* For an able defence of the circular type, see Captain Goulaeff's paper in the *Transactions* of the Institution of Naval Architects for 1876.

about one-eighth more for the circular ship than for the *Devastation*. The deck area of the circular ship would be about 41,000 square feet; the corresponding area in the *Devastation* would not exceed *one-third* that for the circular ship; and here, for equal protection,

	<i>Devastation.</i>	Circular ship.
Horse-power for 13 $\frac{1}{4}$ knots .	I.H.P. 6600	I.H.P. 34,000
Weight of propelling machinery	tons. 1150	tons. 6,000
" coal	1200	6,100
" hull	2880	4,000
Dead weight	4070	4,070
Total displacement	9300	20,170

the *Devastation* would be at a great advantage. On the upper and breastwork decks of the *Devastation*, the mean thickness of the plating may be taken at 2 $\frac{1}{4}$ inches; the total weight is about 500 tons. On the circular ship, 2 $\frac{1}{4}$ -inch plating over the whole area of the deck would weigh about 1600 tons.

These figures sufficiently indicate the unsuitability of the circular form for armoured vessels moving at moderate speeds. The existing vessels are reported to have steamed at very low speeds, and at these to have required an abnormal power. For example, the *Novgorod*, with 2490 tons displacement and 2200 H.P. (indicated), is said to have steamed 7 $\frac{1}{2}$ knots only. In contrast with this, the performance of the coast-defence monitor *Abyssinia* may be mentioned. With a displacement of 2800 tons, she attained practically the same speed with 560 H.P. The model experiments made by the late Mr. Froude disclosed another curious characteristic of the Russian circular ships. As the speed increased the models tended to "dive" below their normal draught, and this fact alone renders it doubtful if, apart from the extravagant expenditure of power, such vessels could be driven at high speeds without danger. These remarks now have only an historical interest, but at no remote period there were many advocates of the circular form or approximations thereto.

In the *Livadia* the Russian designers made a departure from the circular form, and the experiment was sufficiently interesting to justify a brief summary of the results. Although built as an imperial yacht, it was understood that the vessel was regarded also as a model for an armoured ship it was then contemplated to build, of similar form, but much larger dimensions. The *Livadia* was 235 feet long, 153 feet broad, and under trial conditions had a

displacement of about 4400 tons on a draught of 7 to 8 feet. With 12,350 I.H.P. she is said to have attained a speed of 15.725 knots per hour; with about 4800 H.P., 13 knots; and with 3000 H.P., 11 knots. In Fig. 161, the curve AAA shows the curve of indicated horse-power based on these figures. For purposes of comparison there also appear the corresponding curve BBB for her Majesty's ship *Iris*, the curve CCC for the *Merkara* cargo and passenger steamer built by Messrs. Denny; the curve DDD for Royal yacht *Victoria and Albert*; and the curve EEE for the fast passenger steamer *Charles Quint*, built by Messrs.

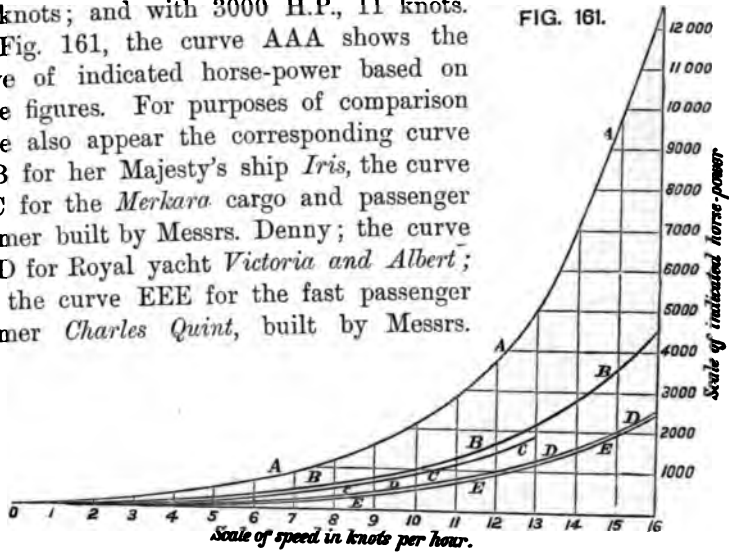

Inglis. The principal particulars of the vessels thus compared are given in the following table:—

Ships.	Length.	Breadth (extreme).	Measured-mile condition.	
			Mean draught.	Displacement.
<i>Livadia</i>	feet. 235	feet. 153	feet. 7½	tons. 4400
<i>Iris</i>	300	46	18	3290
<i>Merkara</i>	370	37½	17	3980
<i>Victoria and Albert</i>	300	40¼	14	2000
<i>Charles Quint</i>	315	33½	14½	2480

The *Livadia* form had very great advantages as compared with the circular form. Model experiments showed that at speeds varying from 13 to 7 knots the *Livadia* form experienced only 60 per cent. of the resistance of the circular form with equal displacement. Her three screws were more favourably placed than the multiple screws of the circular ships; a better supply of water to the propellers was secured, and the augmentation of resistance must have been much less. On the other hand, the diagram shows how very large was the expenditure of power as compared with well-formed ships of ordinary

proportions. When compared also with short bluff-ended armoured ships designed for low speeds, the *Livadia* does not show so badly. For example, the *Hotspur* ram turret-ship of the Royal Navy is 235 feet long and 50 feet broad, and on trial drew $20\frac{1}{2}$ feet, with a displacement of 4180 tons. She attained 11·3 knots with less than 2000 I.H.P., or about *two-thirds* the power required by the *Livadia* for that speed. Allowing for the greater weight of the *Livadia*, and the greater constant friction of her more powerful engines, probably the *Livadia's* performance is about 40 per cent. worse than that of the *Hotspur*, measuring by the ratio of horse-power to weight driven. The most interesting deduction from these trials is the possibility, when necessity arises, in vessels of moderate speed, with a given length and displacement, of exchanging ordinary forms of midship section (where the draught of water is from 40 to 50 per cent. of the extreme breadth) for a very broad, shallow section of equal area. By means of suitable changes in other cross-sections, accompanied by a considerable amount of fineness in the longitudinal sections (buttock and bow-lines), a given speed can be obtained in the broader, shallower vessel with about 40 per cent. more power than in the ship of ordinary form.*

For armoured or protected ships, the *Livadia* form may be regarded as distinctly inferior to the *Hotspur* form. The length along the side at the water-line must be greater than in the *Hotspur*, so that belt protection, if adopted, would be more costly and heavier. The deck area would be very much greater in the *Livadia* form, and for a given thickness of protective plating the weight would be much increased. In the following table a comparison is made between the *Alexandra* and an enlarged *Livadia* of equal displacement:—

	<i>Alexandra.</i>	Enlarged <i>Livadia.</i>
Length	325 feet	300 feet
Breadth	63 feet 10 inches	200 feet
Draught (mean)	26 feet 6 inches	11 to 12 feet
Displacement (tons)	9500	9500
Indicated horse-power	8600	12,500 to 13,000
Speed	15 knots	15 knots

This increase in engine-power would necessitate a proportionate increase to weight of machinery and coals; there would be practically the same length of water-line to protect, and the area of deck

* See papers on the *Livadia* by the *Transactions* of the Institution of Captain Goulaeff and Sir E. J. Reed in Naval Architects for 1881.

requiring horizontal armour would be about double that of the *Alexandra*. Hence it follows that on the *Livadia* form the association of speed, coal endurance, armour, and armament actually existing in the *Alexandra* could not be repeated. It might be possible, of course, to adopt the *Livadia* form in connection with some entirely new disposition of the armament or the protective material, but it is unnecessary to pursue the subject further.

Economical propulsion demands (as explained on p. 459) a due relation between the lengths of ships and their maximum speeds. As speeds have increased, therefore, lengths have been increased in both mercantile and war-ships. For a long time the lengths of war-ships were kept within moderate limits in order to increase handiness when making or avoiding attacks with the ram. It still remains true that, other things being equal, the space and time in turning are increased by increase of length. On the other hand, the development of mechanical appliances for readily operating rudders of large size have greatly increased the power of control, and the introduction of torpedo armaments has made ram-attacks more dangerous than formerly to the ship which tries to ram. The balance of naval opinion in recent years has, therefore, been in favour of greater length, with its consequent advantages of more economical propulsion and better maintenance of speed in rough water. It will be noted that, whereas with maximum measured-mile speeds of 14 to 15 knots armoured ships up to 1885 rarely exceeded 330 feet in length, the corresponding speeds at the present time are 17 to 18 knots, and the lengths 380 to 400 feet. In relation to these speeds, the greater lengths now used are really more moderate than were the less lengths in relation to the speeds formerly accepted. Similar remarks apply to merchant steamers. Lengths of 450 feet were accepted for sea speeds of 15 knots. With the present sea speeds of 20 to 22 knots, the maximum lengths of 525 to 600 feet are relatively moderate. It is unnecessary to repeat the explanations previously given, as to the advantages of length in relation to expenditure of power and dead-weight capacity at moderate speeds, or the distinction necessary between the influence of absolute length and the effect of variations in the proportion of beam to length. Narrowness is not a necessary condition of economical propulsion, and may make against it when there is a long "middle body."

The increase in dimensions and speeds of seagoing steamships made in recent years has been achieved without sensible increase in the draught of water, the upper limit of draught being fixed by the depths available at the ports and docks frequented by ships. From the remarks made on p. 478, it will be understood that if increased draughts were permissible, higher speeds and greater carrying power

might be attained with less relative lengths than are necessary under present conditions. The great influence of increased length on weights of hull has also been discussed on p. 412. This matter has been pressed upon the authorities of harbours, canals, and docks; there is now a fuller recognition of the advantages obtainable with greater draughts; and in many instances steps have been taken to provide greater depths of water.*

During the last thirty years, side by side with the development of the sizes and speeds of ocean steamers there has been in progress the construction of small vessels possessing higher smooth-water speeds for short periods than the larger vessels. Vessels of from 50 to 200 feet in length have been driven at smooth-water speeds of 15 to 27 knots, and have furnished remarkably suggestive facts as to the phenomena accompanying propulsion at very high speeds. The principal characteristics of their machinery and boilers, and of their behaviour, have been dealt with in previous pages. It has been shown that the expenditure of power in proportion to the weight driven is very great, and that the key of all the designs is to be found in the lightness of the propelling apparatus in relation to the power it develops, and in the association of extreme lightness of hull structure with sufficient strength for the special service. The following tabular statement may be of interest as summarizing the relative expenditure of power in propelling these small craft and other vessels of different types and dimensions at the same speeds:—†

	Torpedo-boat.	Torpedo-gunboat.	3rd-class cruiser.	2nd-class cruiser.	1st-class cruiser.		Atlantic passenger steamer (light).
					Edgar.	Blenheim.	
Length	135 ft.	280 ft.	265 ft.	800 ft.	860 ft.	875 ft.	525 ft.
Breadth	14 ft.	27 ft.	41 ft.	48 ft.	60 ft.	65 ft.	63 ft.
Trial draught	5 ft. 1 in.	8 ft. 3 in.	16 ft. 6 in.	16 ft. 2 in.	23 ft. 9 in.	25 ft. 9 in.	21 ft. 3 in.
Trial displacement . .	160 tons	735 tons	2800 tons	3350 tons	7390 tons	9100 tons	11,550 tons
Indicated horse-power—							
For 10 knots	110	450	700	800	1,000	1,500	2,000
„ 14 „	260	1100	2,100	2400	3,000	4,000	4,600
„ 18 „	870	2500	6,400	6000	7,500	9,000	10,000
„ 20 „	1130	3500	10,000	9000	11,000	12,500	14,500

NOTE.—The figures for horse-power are “round.” The 3rd-class cruiser was run at 20 knots in the shallow water at Stokes’ Bay, while the powers for the other ships at that speed correspond to deep water.

Applying the law of corresponding speeds to the performances of the torpedo-boat in this table, some interesting deductions may be made. These speeds, it will be remembered, bear to one another the ratio of the *sixth* roots of the displacements. Comparing the second-

* See the *Proceedings* of the International Maritime Congress. London, 1893.

contributed by the author to the *Transactions* of the Institution of Naval Architects for 1892.

† This table is taken from a paper

class cruiser with the torpedo-boat, the corresponding speeds are as 1.79 : 1 ; for the first-class cruiser, *Blenheim* type, the corresponding speeds are as 2.12 : 1. For the Atlantic steamer the corresponding speeds are as 2.2 : 1. In other words, to 20 knots in the torpedo-boat would correspond speeds of about 36 knots for the second-class cruiser, 42.5 knots for the first-class cruiser, and 44 knots for the Atlantic steamer. The torpedo-boat, therefore, if used as a model for the larger vessels at these respective speeds, would by an analysis of its performance furnish many useful and fruitful suggestions for guidance in dealing with these ships. It will be noted, for example, that the very advantageous conditions of resistance attained by torpedo-boats at their maximum speeds would not be reached by the larger vessels until their speeds were very much greater than any yet attained, or even contemplated at the present time. In view of progress already made, however, it would be unwise to limit future developments, or to assume that the great engine powers necessarily required with increased speeds will not be obtained hereafter with relatively lighter machinery than any yet in use, as well as with greater economy in fuel, and lighter hulls.

CHAPTER XVIII.

THE STEERING OF SHIPS.

SHIPS are ordinarily manœuvred by means of rudders, sails, or propellers driven by steam-power. Steering by sail-power alone may be accomplished by the skilful seaman, if his ship has been well designed. Steering by the action of the propellers alone is also a possibility in certain classes of steamships, and may be a great advantage under certain circumstances. Rudders are fitted, however, in all classes of ships, and form the most important means of controlling their movements under ordinary conditions of service. In this chapter attention will be chiefly directed to the principles upon which the action of rudders depends. A brief notice will suffice respecting manœuvring by the use of propellers; but nothing will be said respecting manœuvring under sails alone, as that is peculiarly a matter of seamanship.

The rudder is almost always placed at the stern of a ship, which is its most advantageous position for controlling her movements when she has headway. In what follows it will be understood therefore, that, unless the contrary should be stated, we are dealing with stern rudders. After discussing their action, a few remarks will be made respecting the use of bow rudders, auxiliary rudders, and other supplementary methods of increasing the turning power of ships.

Two kinds of rudders require to be noticed. First, the *ordinary* rudder, which rotates about an axis near its foremost edge, and is hung to the sternpost of the ship. Fig. 162 shows the common arrangement in a single-screw ship. AA is the *axis* of the rudder, the line passing through the centre of the pintles by which the rudder is hung to the after sternpost, or rudder-post. In the plan, AB represents the rudder put over to port, the helm being a star-board. In sailing ships, paddle steamers, jet-propelled vessels, and twin-screw ships, the ordinary rudder is hung to the after end of the ship, there being only one sternpost in such vessels. Fig. 163 shows

the common arrangement in twin-screw ships; and, apart from the propellers, the drawing will also serve for the other classes named. A few ships have had the rudders placed before the single-screw

FIG. 162.

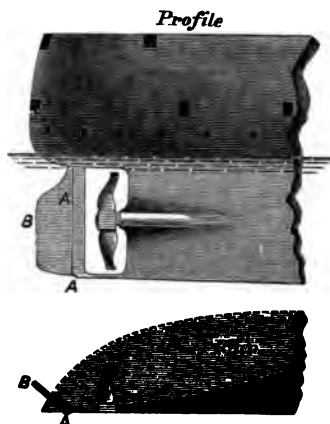
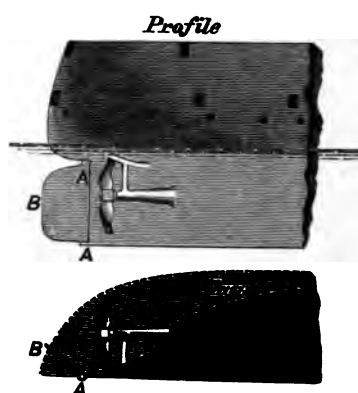

FIG. 163.



propellers, but this is not a common plan; when it is adopted, the rudder is generally of the ordinary kind, and is placed in the after deadwood below the screw-shaft.

The second form to be noticed is the *balanced* rudder, which differs from the ordinary form in having a part of its area—usually about one-third—before the axis about which it rotates. This kind of rudder has been used in many steamships of the mercantile marine and the Royal Navy. Fig. 164 illustrates a common arrangement: AA is the axis. There is no rudder-post, the weight of the rudder being taken inboard, and the lower bearing at the after end of the keel is made use of simply to steady the rudder. In some cases balanced rudders have been fitted without the lower bearing, the rudder-head being made exceptionally strong; but this plan has considerable disadvantages in large ships, especially as regards liability to derangement by shocks or blows of the sea. Usually the balanced rudder is made in one piece, and, when, put over, occupies a position similar to that indicated (in plan) by Fig. 165, the part AC before the axis A being rigidly attached to the part AB abaft it. When the rudder is thus made in one piece, it is termed a “simple” balanced rudder. In a few war-ships having auxiliary sail-power as well as steam, so-called “compound” balanced rudders have been fitted in the manner illustrated by Figs. 164–166. The part before the axis is attached to a hollow annular head, up through which passes the rudder-head which carries the after part of the rudder; and the two parts are hinged to one another along the axis. When

the ship is under steam, the two parts can be locked together and made to act as a simple balanced rudder; when she is under sail, the forepart of the rudder can be locked fast in the line of the keel (as shown by AC, Fig. 166), occupying a position resembling

that of the rudder-post in ordinary screw steamers, and the after part alone (AB) is used to steer the ship. This more complicated arrangement was devised because, in some of the ships first fitted with large balanced rudders, complaints were made that evolutions under sail were hindered by the "drag" of these rudders, as compared with ordinary rudders of less area. As experience was gained, however, less helm angles were used with the large balanced rudders when under sail, and the difficulty in manœuvring disappeared. Some of the compound rudders, in fact, have had their two parts rigidly secured to one another, and are now worked as simple balanced rudders.

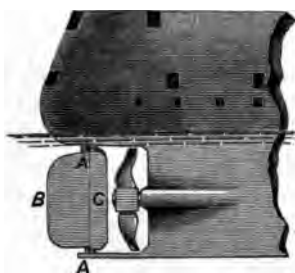

FIG. 164.



FIG. 165.



FIG. 166.

Another form of rudder is illustrated by Fig. 167. It resembles an ordinary rudder in its mode of suspension, by pintles, to the body-post. The deadwood of the ship is cut away, and the lower part of the rudder extends forward below the ship. In this way a comparatively small proportion of the total rudder area can be made to balance, or nearly balance, the remaining part abaft the axis. The lower forward portion of the rudder is exceptionally well placed for steerage. Rudders of this kind have been fitted to torpedo-boats built by Mr. Yarrow, and also to torpedo-gunboats of the Royal Navy. Rudders identical in principle, but differing in details, have been fitted by Messrs. Thomson to some very large and swift merchant steamers, as well as to cruisers. In all cases these rudders have proved efficient both for headway and for sternway.

FIG. 167.

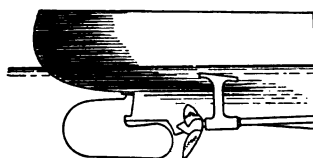
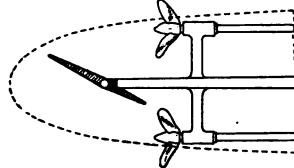
Profile.*Plan.*

In a considerable number of small vessels and torpedo-boats an arrangement of balanced rudders has been fitted similar to that illustrated in Fig. 168. Mr. J. S. White has chiefly developed this arrangement, which is known as the "turn-about" system. A modification of the plan has been carried out in torpedo-gunboats of the Royal Navy. One of the two rudders is before and the other abaft the athwartship vertical plane passing through the centre of the screw propeller or propellers. The deadwood is cut away to a considerable extent to facilitate turning. Both rudders are controlled by the same steering gear, and act together. Excellent manœuvring

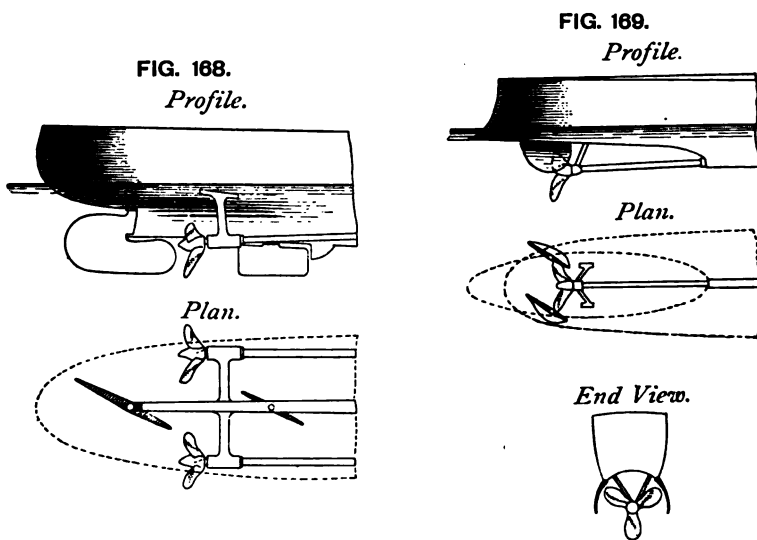

power is thus obtained, not merely when a vessel is going ahead, but also when she is moving astern. The plan is applicable both to single and to twin-screw ships.

Mr. Thornycroft has introduced a plan, illustrated in Fig. 169, of "twin" balanced rudders in torpedo-boats. This has answered admirably. Instead of a single balanced rudder at the middle line one is fitted on each quarter abreast of and outside the screws. The rudder heads are carried inboard and strongly held; there is no bearing at the heels of the rudders. When the helm is amidships, the blades of the rudders and the suitably shaped stern between them form a "tunnel" in which the propeller works, and it is considered that greater efficiency in propulsion is thus obtained, while the "race" of the screw is utilized for steering either ahead or astern.

Both ordinary and balanced rudders may be regarded simply as plane surfaces which, by means of suitable mechanism, can be placed at an angle with the keel-line. It is customary to speak of the

“angle of helm” rather than the rudder angle. “Helm a-starboard” means that the rudder has been put over to *port*, and that the head of the ship moves to *port*. “Helm a-port” means that the rudder has been put over to *starboard*, and that the head of the ship moves to *starboard*. A sailing ship has “weather-helm” when the rudder has been put over to the leeward side, in order to make the head of the ship fall off from the wind. When the helm is “a-lee,” the rudder has been put over to the windward side, in order to bring the head of the ship up to the wind.

In discussing the action of the rudder, it will be convenient to consider separately the following features:—

1. The causes which produce, and govern the amount of, the pressure on the rudder, making it effective in turning a ship.
2. The relation which exists between the pressure on the rudder and the force required at the tiller end to hold the helm at any angle desired; as well as the work to be done in putting the helm over.
3. The turning effect on a ship produced by the pressure on the rudder.

The first and second of these subdivisions are very closely connected. In discussing the third, it will be necessary to distinguish between, what may be termed, the *initial* motion of a ship when her helm is put over, and her subsequent motion when the speed of rotation has become approximately uniform.

Causes of Pressure on Rudders.—When a rudder is placed obliquely to the keel-line of a ship, and streams of water impinge upon its surface in consequence of the motion of the ship, or the action of her propeller, the motions of these streams must be more or less checked or diverted, and a change of momentum is produced, which reacts upon the rudder and causes a normal pressure upon its surface. If all these streams were moving with uniform velocity and with parallel lines before they impinged on the rudder, the normal pressure upon it could be estimated approximately by the rules stated for thin plates on p. 440. Since rudders are commonly not wholly submerged, these rules would give somewhat less than the true pressure. In practice the streams impinging upon a rudder do not move in parallel lines or with uniform velocity; and to estimate strictly the normal pressure on a rudder it would be necessary to take account of the velocity and direction of motion of the water in each elementary stream, in order to determine the change of momentum. Approximate estimates suffice, however, for practical purposes, and in making such estimates it is customary to express the speed of approach of the streams to the rudder either in terms of speed of the ship or that of her propeller, assuming the same speed for all the streams.

If the vessel is moving ahead in a straight course and her helm is put over, it is usual to assume that the streams are flowing parallel to the keel, and that the angle of obliquity to be used in estimating the effective pressure on the rudder is the angle which it makes with the keel. As soon as the turning effect of the rudder begins to be felt by a ship, and she acquires angular motion as well as translatory motion, the conditions are altered, and the effective angle of obliquity of the rudder is usually made less than its angle with the keel. This has been proved experimentally, and will be made the subject of further remark when considering the phenomena attending the turning of ships. In making approximate estimates of the rudder pressure, it is usual, however, to take the helm angle with the keel as the effective angle of obliquity.

Although these assumptions are commonly made in calculations for the sizes and strengths of rudders and steering gear, no one supposes them to strictly represent the facts, even in the simplest case, such as that of a sailing ship running dead before the wind. From the explanations given on p. 455, as to the stream-line motions at the stern of a sailing ship thus circumstanced, it will appear that the speeds and directions with which the streams impinge upon the rudder will vary with the headway, the form of the stern, the roughness of the bottom, and the helm angle. When a ship is not running before the wind, she has leeway as well as headway, and is inclined to the upright, all of which circumstances affect the stream-line motions, and the normal pressure on the rudder; but their influence cannot be exactly estimated, and is of little practical importance.

The rudder pressure which is effective for turning a ship obviously has no connection with the hydrostatical pressure which would be acting upon the surface, if the rudder were put over to any angle when the ship was at rest in still water. This distinction is mentioned because some persons have confused hydrostatical pressure with the pressure or reaction due to the relative motion of the streams and the rudders, and have proposed to shape the rudder according to laws based upon this wrong assumption. The mistake made is similar to that referred to at p. 438, as to the relative resistances of a plane surface wholly or partly submerged; but there can be no question that without motion of the ship, or of the water past the rudder, the rudder can have no steering power.

Paddle-wheel steamers and jet-propelled vessels differ somewhat from sailing ships in their steerage power. The latter require to be in motion if the water is still—to have “steerage way”—before the rudder can act; but the former may acquire steerage power with little or no headway by means of the action of their propellers. If the wheels of a paddle steamer are started, for example, when she is at

rest in still water, a paddle race is driven astern at considerable speed on each side; and it is a matter of common experience that this motion of the race relatively to the rudder will develop an effective pressure and bring the ship under control by her rudder, before she has gathered much headway. Similar conditions probably hold good in jet-propelled vessels, although experience with them is limited. In both these classes of vessels, when their speed has been increased by the continued action of the propellers, and approximately uniform motion has been attained, the influence of the propeller race becomes far less, and the steering power of the rudder is governed mainly by the speed of the vessel, the fineness of the run, and other conditions closely agreeing with those described for sailing ships.

The steerage of screw-steamers presents certain special features deserving careful consideration. In single-screw ships as ordinarily constructed, the propeller is situated immediately before the rudder; when a vessel is moving ahead the race is driven aft more or less directly upon the fore side of the rudder, and when she is moving astern the action of the propeller induces a forward pressure on the after side of the rudder. The particles of water in the propeller race have rotary as well as sternward motion communicated to them, and, moving in more or less spiral paths, impinge upon the rudder in directions which may depart widely from parallelism with the keel-line. Experiments have been made to determine the "position of zero-pressure" for rudders placed behind single screws, and they indicate clearly the obliquity of the motion of the streams in the race. Herr Schlick, for example, divided an ordinary rudder into two equal parts, in the steamer *Vinodol*; the line of section being horizontal. When the screw was at work, the lower half found its position of rest at an inclination of rather less than 10 degrees on one side of the keel-line, while the upper half rested at nearly an equal inclination on the other side of the keel-line. In other cases the helm has been left free while the screw was at work, and the rudder has been found to rest at a sensible angle to the keel-line, the effective pressure of the streams delivered by the lower blades being predominant over that of the streams delivered by the upper blades. This position of rest or zero pressure is clearly that from which the effective rudder angle should be reckoned, and not from the keel-line, in estimating the initial pressure on a rudder put over when a single-screw ship is proceeding on a straight course. Further, it will be noted that, to obtain equal pressures on opposite sides of the keel, the helm must be brought to a greater angle with the keel-line on one side than on the other. This has been considered disadvantageous, and various proposals have been made to remedy the supposed loss of efficiency, but they have not found favour in practice.

The influence of the propeller upon the steerage of single-screw ships is illustrated by the well-known practice of "slewing" ships completely round in a very limited space. Suppose a vessel to be at rest in still water, and that her screw is started ahead; it delivers a race having considerable sternward velocity and thus gives good steerage power before the vessel has gathered headway. The head of the ship begins to turn, say to starboard, the helm being a-port; and when headway is becoming sensible the engines are reversed, the helm put a-starboard, and by the action of the screw a pressure is developed on the aft side of the rudder tending to augment the previous motion of the head of the ship to starboard. In this manner, by suitable manipulation of engines and rudder, the ship can be turned completely round in a very small space, if that manœuvre should be thought necessary. The time occupied in turning would, of course, be considerable as compared with that needed for turning under way.

Twin screws, placed in the manner indicated in Fig. 163, are not so favourably situated as single screws for influencing the effective rudder pressure by the motion of the race. But the same kind of influence is exerted to some extent; and to give it marked effect, rudders of large longitudinal dimensions have been fitted in many twin-screw war-ships. These broad rudders sweep out to a considerable distance from the keel-line, even for moderate helm angles, and their after parts, at least, come fully under the influence of the screw race. Experience shows this simple expedient to be very effective; for example, in the *Inflexible*, an addition fitted to the after part of the rudder caused a sensible improvement in the steering. No serious difficulty is encountered in the steering of twin-screw ships when proper care is bestowed upon the rudder and steering gear, as will be seen from the facts given at the end of this chapter.

So far as the action of the rudder is concerned, therefore, the form of the after part of either single or twin screw steamers is not so important as it is in sailing, paddle, or jet-propelled vessels; but it has been shown (on p. 605) how necessary to the efficiency of screws as propellers is fineness of form in the after body.

Broadly speaking, it may be said that, when a screw-steamer is moving ahead, the velocity with which the streams impinge upon her rudder, if placed abaft the screw, equals the *speed of the screw*, and therefore equals the sum of the speed of the ship and slip of the screw. When the slip is considerable, as it may be in some cases, the increase in rudder pressure and steering effect above that due to the headway of the ship may be a most valuable element in her handiness. Similar reasoning applies to the case where the propeller is driving a ship astern at a steady speed. But the most important

case of screw-ship steerage is that when, to avoid a collision or any other danger, the engines of a screw steamer are suddenly reversed, say from full speed ahead to full speed astern. The vessel will then maintain headway for a short time, but the effect of the propeller race upon the rudder may more than counterbalance the effect of headway, and the vessel may steer as if she were moving astern, the resultant pressure being delivered upon the after surface of the rudder.

This feature of screw-ship steerage has long been known. An analogous experiment was made with the *Great Britain* in 1845; and it was found that, when the vessel was going astern at the rate of 9 or 10 knots, if the engines were rapidly reversed, she steered immediately as if she were going ahead. Similar experience appears to have been gained with the *Archimedes* and other early screw-steamers. Experiments of a more detailed character made by a Committee of the British Association, appointed in consequence of action taken by Professor Osborne Reynolds, have added valuable information. The main purpose of the inquiry was to discover the best rules for the guidance of ships' captains in endeavouring to avoid collisions; and the following extracts from the final Report summarize the principal conclusions reached.

“It appears both from the experiments made by the Committee, and from other evidence, that the distance required by a screw-steamer to bring herself to rest from full speed by the reversal of her screw, is independent, or nearly so, of the power of her engines, but depends upon the size and build of the ship, and generally lies between four and six times the ship's length. It is to be borne in mind that it is to the behaviour of the ship during this interval that the following remarks apply.

“The main point the Committee have had in view has been to ascertain how far the reversing of the screw in order to stop a ship did, or did not, interfere with the action of the rudder during the interval of stopping; and it is as regards this point that the most important light has been thrown on the question of handling ships. It is found an invariable rule that, during the interval in which a ship is stopping herself by the reversal of her screw, the rudder produces none of its usual effects to turn the ship; but that under these circumstances the effect of the rudder, such as it is, is to turn the ship in the opposite direction from that in which she would turn if the screw were going ahead. The magnitude of this reverse effect of the rudder is always feeble, and is different for different ships, and even for the same ship under different conditions of lading.

“It also appears from the trials that, owing to the feeble influence

“of the rudder over the ship during the interval in which she is
“stopping, she is then at the mercy of any other influences that may
“act upon her. Thus the wind, which always exerts an influence to
“turn the stem (or forward end) of the ship into the wind, but which
“influence is usually well under control of the rudder, may, when the
“screw is reversed, become paramount, and cause the ship to turn in
“a direction the very opposite of that which is desired. Also the
“reversed screw will exercise an influence which increases as the
“ship’s way is diminished to turn the ship to starboard or port, accor-
“ding as it is right or left handed; this being particularly the case
“when the ships are in light draught.

“These several influences, the reversed effect of the rudder, the
“effect of the wind, and the action of the screw, will determine
“the course the ship takes during the interval of stopping. They
“may balance, in which case the ship will go straight on; or any
“one of the three may predominate and determine the course of the
“ship. The utmost effect of these influences when they all act in
“conjunction—as when the screw is right-handed, the helm star-
“boarded, and the wind on the starboard side—is small as compared
“with the influence of the rudder as it acts when the ship is steaming
“ahead. In no instance has a ship tried by the Committee been able
“to turn with the screw reversed on a circle of less than double the
“radius of that on which she would turn when steaming ahead. So
“that even if those in charge could govern the direction in which the
“ship will turn while stopping, she turns but slowly; whereas, in point
“of fact, those in charge have little or no control over this direction,
“and unless they are exceptionally well acquainted with their ship,
“they will be unable even to predict the direction.”

Similar trials have been made in ships of the Royal Navy, in order to determine their behaviour as regards stopping and turning when the screws have been reversed. In comparing the results with those obtained by the British Association for merchant ships, it is necessary to bear in mind certain facts. War-ships differ from merchant ships in their forms, the proportion of engine-power to displacement, the area of their rudders and other features influencing their behaviour under the experimental conditions. Allowing for these differences, and recognizing the necessarily approximate character of the results obtained in such trials, the following summary will be of general interest.

First, as to the distances traversed after war-ships have their engines reversed. If ships are moving full speed ahead, they can usually be stopped in from $2\frac{1}{2}$ to $4\frac{1}{2}$ times their length. In some few cases they were stopped in from $1\frac{1}{2}$ to 2 lengths. If ships are moving at slow speed, but with a large command of steam, so that the

engines can be worked full speed astern quickly, the distances travelled before stopping are much reduced, varying in many instances from 40 to 70 per cent. of the distances traversed when reversing from full speed ahead.

Second, as to the steerage of single-screw war-ships with engines moving astern. This is the case comparing with the British Association experiments, which were made on single-screw merchant ships. While there is a general agreement between the two sets of trials, there are some differences. When the helm was put over, and a ship had begun to answer her helm, before the engines were reversed, she usually continued to turn in the same direction, but at a gradually decreasing rate, after the screw was reversed up to the moment when she ceased to have headway. Some ships turned in the original direction for a short time only after the engines were reversed, the propeller race overpowering the influence of headway on the rudder very soon, and causing the ships to swing round in the opposite direction to that in which they were turning before the engines were reversed, just as the single-screw merchant ships did.

When the engines of single-screw war-ships were reversed at the same instant as the helm was put over, they behaved in an uncertain fashion, much as described above for single-screw merchant ships. In most cases the war-ships were found, when headway ceased, to have their heads turned slightly from their original course to the side where the rudder would have turned them under the influence of headway.

Twin-screw ships usually continue to have headway when one screw is reversed and the other continues to turn ahead; the reason for this will be found on p. 578. Consequently the reversal of one screw did not, in the course of the trials, bring the ships to rest, or make them turn on their centres; but caused them to reverse their course or turn a complete circle in a smaller space than when both screws were moving ahead and the same amount of helm was used. This was true, whether the helm was put over before, or simultaneously with, the reversal of the engines. It will be explained hereafter that, when required, by suitably adjusting the revolutions and directions of movement of the screws, a twin-screw ship may be turned practically on her centre.

Summing up these remarks on the causes which govern the pressure on the rudders of different classes of ships, it may be said generally that without motion of a ship through the water, or of the water past the rudder, it can have no steering power. A ship or boat anchored in a tidal current or river may be turned to some extent from the line of flow by the action of her rudder, because the water has motion relatively to the rudder. A ship almost destitute of

headway may be under command, if her propeller is at work and delivering a race which flows past the rudder. But for a ship at rest in still and undisturbed water the rudder is powerless. The hydrostatical pressure sustained by the sides of the rudder, if held at any angle, balance one another, and are quite distinct from the reaction due to change of momentum in streams having motion relatively to the rudder.

In all cases of relative motion of water and rudder, the normal pressure depends upon the area of the immersed part of the rudder; the angle of its obliquity to the position of zero pressure, or, roughly speaking, to the keel-line; and the speeds and directions with which the streams impinge upon the rudder surface. In sailing ships the motions of the streams depend principally upon the motions of the ships, and the forms of the after body. In paddle-steamers and jet-propelled vessels similar considerations are most influential, although the action of the propellers may influence the steerage of ships starting from rest, or reversing their course. In screw-steamers the action of the propellers is very important, especially when the slip is considerable, and the velocity of the race is high.

When ordinary rudders are employed, and hung either to a broad rudder post abaft the screw, as in Fig. 162, or to the body of the ship, as in Fig. 163, the check put upon the motion of the streams by the rudder must produce a reaction and pressure not merely upon the rudder itself, but upon the portion of the stern-post or deadwood adjacent to the rudder. This additional pressure will be delivered on the side towards which the rudder is put over, and there is good reason for believing that it considerably assists the rudder pressure in steering a ship, being most valuable in cases where the rudder is hung to the body of the ship. With simple balanced rudders placed as in Fig. 165, there is no corresponding pressure on the deadwood, but instead of it a normal pressure on the additional rudder area placed before the axis. Compound balanced rudders, with the forward part locked fast (as in Fig. 166), resemble the case illustrated in Fig. 162 for an ordinary rudder.

Besides these normal pressures on the rudder, stern-post, and deadwood, there will be a certain amount of *frictional* resistance on the rudder surface when placed obliquely; but this is of little importance as compared with the normal pressures except for very small angles of helm. So far as it produces any effect on the steering, this frictional resistance acts against the normal pressures.

It has been shown in Chapter XI. that surface disturbance may become an important factor in fluid resistance. As rudders in most classes of ships extend above the water-level, some surface disturbance occurs when the helm is put over, and this increases the reaction on

the rudder. In war-ships, both armoured and protected, it is usual to keep the rudders and steering gear well below the water-line, and consequently there is little or no surface disturbance. For smooth-water work, this point has but small practical importance. In rough water at sea, however, the upper portions of rudders as ordinarily fitted are exposed to blows of the sea, which sometimes involve heavy shocks on rudders and steering gear. These blows are avoided to a considerable extent in rudders completely submerged. In a few of the largest and swiftest Trans-Atlantic steamers such rudders have been fitted, no doubt chiefly because of the advantages that would be gained if the vessels were employed in war, but partly in order to reduce the risks above mentioned.

Forces required on Tillers.—Reference will next be made to the force required at the tiller end to hold the rudder at any angle. This will, of course, depend upon the length of the tiller and the mode of applying the force; but it may be assumed that both these conditions are given. In Fig. 170 an ordinary rudder is shown. The resultant pressure upon it is P , acting through the centre of effort C of the immersed rudder area. AT represents the tiller, Q the force required at its end, if applied normally to the tiller, in order to hold the rudder over. Apart from friction of the pintles, rudder bearings, collar, etc., we should have—

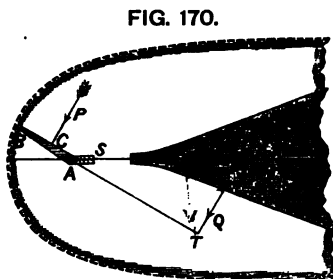

$$P \times AC = Q \times AT.$$

These frictional resistances vary considerably in different vessels, but may be made comparatively small by means of careful arrangements; in most cases they probably act with the force Q in resisting the motion of the rudder back towards the keel-line. Neglecting friction, and supposing the other conditions fixed, the force Q at the tiller end will vary with the distance AC of the centre of effort from the axis of the rudder. On the same assumption the force Q may be determined approximately for any helm angle, if the distance AC is known, since the normal pressure P can be estimated roughly in the manner described on p. 440. In practice the maximum helm angle varies from 30 to 45 degrees; so that inquiries as to the variation in the value of AC need not be carried beyond 45 degrees except it be done for scientific purposes. Formerly it was assumed that the centre of effort coincided with the centre of gravity of the immersed area of the rudder, and that the pressure due to the reaction of the

streams was uniformly distributed over that area. Experience and investigation have proved this view to be incorrect for a thin plate set obliquely to the line of motion, and for actual rudders. In the case of balanced rudders, for example, it has been ascertained that, when the area before the axis was about one-half as great as the area abaft the axis, a dynamometer attached to the tiller end when at 40 degrees indicated little or no strain, showing that the centre of effort was then practically coincident with the axis. With ordinary rudders a similar excess of pressure probably exists on the forward part; although it is conceivable that in twin-screw ships the more direct action of the race on the after part of the rudder may tend to modify the position of the centre of effort. If the rudder be treated as a rectangular plate advancing obliquely, its leading edge (corresponding to the fore edge of a rudder) may be regarded as continually entering water which was comparatively little disturbed by the previous motion, and which, therefore, reacts more powerfully on that part of the area than does the water which impinges upon the after part, and which had been previously disturbed by the motion of the plate. This matter has been dealt with mathematically by Lord Rayleigh and experimentally by M. Joëssel, the late Mr. Froude, and others. For a rectangular plane of breadth b , the distance d of the centre of pressure from the forward edge has been expressed by the following formulæ, α being the angle made by the plane with its line of motion:—

$$\text{Lord Rayleigh . . . } d = \frac{b}{2} - \frac{3}{4} b \cdot \frac{\cos \alpha}{4 + \pi \sin \alpha}$$

$$\text{M. Joëssel } d = 0.195b + 0.305b \cdot \sin \alpha.$$

Herr Hagen, after numerous experiments on comparatively small plates, proposed the following approximate formula:—

$$d^2 = (b - d)^2 \cdot \frac{\alpha^\circ}{90^\circ}$$

For angles below 10 degrees there is considerable difficulty in determining experimentally the value of d ; but from 10 degrees up to 45 degrees there is greater certainty. The results obtained independently by Mr. Froude and M. Joëssel agree closely with one another, and confirm the general accuracy of Lord Rayleigh's formula. At 10 degrees the centre of effort is about *one-fourth* the breadth from the leading edge; at 20 degrees, about *three-tenths* of the breadth; at 30 degrees, *three-eighths* of the breadth; at 40 degrees, *four-tenths* of the breadth. These values may not apply exactly to rudders, owing to the variations in the directions and velocities of the streams impinging upon the surface; but they may be treated as approximately correct.

M. Joëssel was led from his experiments to a very simple law, which confirms previous practice: viz. that for a rectangular plate hinged at its fore edge, and inclined at an angle α to the line of motion, the moment of the normal pressure about the axis divided by $\sin \alpha$ is a *constant*. Using the notation of Fig. 170, this law is as follows:—

$$P \times AC = \text{constant} \times \sin \alpha.$$

The constant in this expression is simply the moment of the normal pressure when the plate advances at right angles to itself, which moment can be found by the rules already given. If this law be accepted, an estimate for the force required at the tiller end at any angle α can be very readily made.

In a balanced rudder of the usual proportions, about one-third of the total area is placed before the axis, as it is desired to give the rudder the power of "righting" itself rapidly when the strain on the steering gear is relieved. Cases have occurred where rudders have been overbalanced and would not right when the strain on the tiller was relieved. This fault is easily remedied by cutting away a portion of the rudder before the axis. Ordinarily the distance of the centre of pressure abaft the axis is small when a ship is moving ahead, even for large angles of helm. For helm angles below 10 or 15 degrees the centre of pressure may be a little before the axis. Hence it happens that with a rudder, properly balanced, a small force applied at the tiller end suffices to hold the rudder steady; whereas, for an ordinary rudder having an equal area and held at an equal angle, the force at the tiller end has to balance the very considerable moment of the pressure about the axis.

M. Joëssel some years ago proposed a special form of balanced rudder designed to still further diminish the force required at the tiller end when dealing with large areas and considerable helm angles. Instead of being formed in one solid blade, it consisted of two or three blades set parallel to one another and turning about one axis. The distance between the blades was made considerable in relation to their fore and aft measurement, so that the streams of water could pass freely between them and operate upon the surface of each blade. Very extensive experiments have been made with these rudders in the French Navy, and a few trials have been made in the Royal Navy. They are reported to have fulfilled the expectations of M. Joëssel, and to have enabled very large effective rudder pressures to be obtained with moderate power at the steering wheel. From the particulars which M. Joëssel has himself furnished to the author, and from official reports of the trials of French ships, it is evident that with these two or three-bladed rudders and a given

power at the wheels, French war-ships have been turned much more quickly and in less space than with ordinary rudders. In one example with 35 degrees of helm, a vessel fitted with an ordinary rudder turned in a circle of 340 metres diameter, occupying $6\frac{2}{3}$ minutes in the manœuvre; whereas with equal helm and the same number of revolutions of the screw, a two-bladed rudder enabled her to complete a circle of 270 metres diameter in $5\frac{2}{3}$ minutes. It does not appear, however, that the double or triple-bladed rudders are greatly superior in steering effect to single-bladed balanced rudders. For instance, in two French armoured corvettes of the same class, one had the usual form of balanced rudder, the other a triple Joëssel rudder of about 75 per cent. greater area. Under nearly identical conditions of speed and helm angle, the first turned in a circle of which the diameter was about 5.7 times her length, and the other, with the triple rudder, turned in a circle of which the diameter was about five times the length. In some English ships with simple balanced rudders the corresponding ratios have been quite as low as any obtained with the Joëssel rudder. The advantage in point of steering of the Joëssel rudder is obtained at the expense of a greater weight, but the excess is not important. It is also stated that there is a sensible loss of speed, especially in high-speed ships, when multiple-bladed rudders are used. In recent French ships, supplied with steam steering gear, this form of rudder has not been fitted. Larger rudders can of course be worked with these appliances, and economy of power at the steering wheel becomes less important; so that the Joëssel principle loses much of its value.

In considering the strengths necessary for rudder heads and steering gear when balanced rudders are employed, it is obvious that the critical case may be that corresponding to rapid motion of a ship *astern*. Then the leading edge from which the foregoing distances of the centre of effort must be measured is the after edge of the rudder; and that centre of effort may be about one-third of the full breadth of the rudder abaft the axis. Speed *astern*, of course, never equals the maximum speed ahead; but, in war-ships especially, considerable speeds may be reached, and the resulting moment of the pressure on the rudder about the axis may then have its maximum values. Under these circumstances some force must be exerted on the tiller end in order to "right" the rudder.

Many attempts have been made to determine the actual forces required to be exerted on tillers in order to hold rudders of known areas at certain angles, with ships moving at various speeds. The results accessible are mostly open to doubt as regards their absolute trustworthiness, and they are interesting chiefly to the designers of steering gear. From the explanations given hereafter, it will be

seen that the conditions of pressure on the rudder are necessarily varying as a ship acquires angular velocity in turning and loses speed. Unless these variations are recognized, and a continuous record kept of the path on which the ship turns, and her position at any moment, the dynamometric measurements are of very little value as checks upon the estimates of the moment of pressure on a rudder made in the ordinary manner according to Beaufoy's and Joëssel's formulæ.

Mechanical Work done in putting Rudders over.—The work to be done in putting a rudder over to any angle includes that required to overcome the moment of the pressure about the axis, and that needed to overcome the frictional and other resistances of pintles, bearings, and steering gear proper. There may, of course, be a considerable amount of waste work between the steering wheels and the tiller end, through friction of wheels, rods, chains, blocks, screws, etc.; but with these we are not now concerned. The *useful work* done in putting the rudder over is that spent in overcoming the moment of the effective pressure on the rudder at each instant as it moves from amidships to the extreme angle (see the parallel case on p. 158). For a balanced rudder this useful work is very trifling. For an ordinary rudder it may be represented *approximately* by the expression—

$$\text{Useful work} = \text{constant} \times \text{vers. } a \quad (1 - \cos \alpha)^2$$

where a is the extreme angle reached, and the "constant" equals the product of the pressure on the rudder when moved normally to itself at the given speed by about half the mean breadth of the rudder. As an illustration of the use of this approximate formula, take a case where it is desired to put over an ordinary rudder, having an area of 180 square feet, and a mean breadth of 7 feet, to an angle of 45 degrees, the ship having a single screw, for which the speed is 25 feet per second (about 15 knots). Neglecting the obliquity and varying speeds of the streams in the screw race, and supposing them all to flow fore and aft at a speed of 25 feet per second, the following expressions hold:—

$$\begin{aligned} \text{Normal pressure on rudder} &= \frac{\text{lbs.}}{\text{sq. ft.}} \times \frac{\text{lbs.}}{\text{sq. ft.}} \times \text{sq. ft.} = 1.12 \times 180 \times (25)^2 = 126,000; \\ \text{Useful work} &= \text{normal pressure} \times \text{half mean breadth} \times \text{vers. } 45^\circ \\ &= 126,000 \text{ lbs.} \times 3\frac{1}{2} \text{ feet} \times (1 - \frac{1}{2}\sqrt{2}) \\ &= 129,000 \text{ foot-pounds (nearly).} \end{aligned}$$

If steam steering gear were applied, and 12 seconds were named

as the time for putting the helm hard over, the nett horse-power of the steering engine would be given by the expression—

$$\text{Nett horse-power} = \frac{129,000}{550 \times 12} \text{ (roughly).}$$

The actual indicated horse-power of the engine would, of course, be much greater in order to allow for its own waste-work, friction of steering gear, rudder, etc.

When manual power alone is available for steering, balanced rudders have the great advantage of enabling large areas to be put over rapidly to considerable angles; and it was this superiority over ordinary rudders which led to their general use in the larger ships of the Royal Navy between 1863 and 1868.

The balanced type of rudder has been long known. Earl Stanhope proposed it in 1790; it was fitted to a ship by Captain Shulham about thirty years later, and adopted in the *Great Britain* about 1845. It was not introduced into the Royal Navy until 1863, when the steering gear in use, worked by manual power, had failed to give satisfaction in the long swift ships of the *Warrior* class, and in many other screw-steamers of less size. The extreme angles of helm that could be reached did not exceed 18 to 25 degrees; and to secure even these results there was such a multiplication of tackles between the steering wheels and the tillers as made the loss of power in friction very considerable, and the time of putting the helm over very long. On one occasion, for example, the *Black Prince* was turned in a circle with her rudder 30 degrees from the keel-line; to put the helm over occupied $1\frac{1}{2}$ minutes, to complete the circle $8\frac{1}{2}$ minutes were taken, and forty men were engaged at the steering wheels and relieving tackles. On another trial, the *Minotaur*, with eighteen men at the wheels and sixty at the relieving tackles, turned a circle in about $7\frac{2}{3}$ minutes, $1\frac{1}{2}$ minutes being occupied in putting the helm over to the very moderate angle of 23 degrees. Balanced rudders enabled both these faults to be corrected, the helm being put up to angles of 35 degrees or 40 degrees very quickly, by the application of a very moderate force at the steering wheels. The *Bellerophon* was the first ship fitted on this principle; and on trial her rudder, which had an area about 25 per cent. greater than that of the *Minotaur*, was put over to an angle of 37 degrees in about 20 seconds by eight men, when the ship was steaming nearly at the same speed as the *Minotaur* had attained. The *Hercules*, steaming at a higher speed than the *Minotaur*, had her larger rudder put over to 40 degrees in 32 seconds by sixteen men at the steering wheels, and completed a circle in 4 minutes. Further examples of the economy of power and rapidity of motion rendered possible by

the balanced rudder will be found in the records of trials of her Majesty's ships.*

Various proposals were made about the same time as balanced rudders came into use, to reduce the work necessary to put ordinary rudders hard over. Mr. Ruthven, known chiefly for his advocacy of the jet propeller, devised a system of counterbalancing for ordinary rudders by means of weights fitted within the ship; but we are not aware that the plan has ever been adopted. The additional weights and complications involved in such an arrangement are objectionable, especially if applied to rudders of large area.

The application of steam or hydraulic power to steering gear became a necessity as steamships increased in size and speed. Mr. McFarlane Gray designed and introduced the earliest successful steam-steering engine, one on his plan being fitted to the *Great Eastern*. Since that date many other plans for steam-steering have been devised; and steam is now generally used for the purpose in war-ships of all classes, in torpedo-boats, and in seagoing merchant steamers. Hydraulic gear is fitted in a few cases, both in war-ships and in merchant ships; it has certain advantages, but is heavier and more costly than steam-gear. Electricity and compressed air have also been proposed or tried in a few cases. By means of either hydraulic or steam power the largest rudders can be worked and put hard over in a few seconds by one or two men, or by the commanding officer himself, when ships are moving at the highest speeds. It still remains true that the adoption of balanced rudders minimizes the work to be done in steering; and in many of the swiftest ships such rudders have been used in recent years, being associated with steam or hydraulic power. In most merchant steamers and in the largest battle-ships of deep draught it is customary to use ordinary rudders, which are considered less liable to serious damage than balanced rudders if ships take the ground or sustain heavy shocks. With steam power there is no difficulty in handling rapidly even the largest of these ordinary rudders.

By common consent hand steering-gear is fitted in nearly all ships, in addition to steering-engines, so as to provide for possible accident to or temporary cessation of the working of the latter. Hand gear is used also in war-ships at times, when making long passages, and it has been proved by experimental trials that cruisers fitted with balanced rudders can be steered by hand at very high speeds. Considerable improvements have been made recently in hand gear. For manœuvring purposes, however, mechanical power is always used; under these

* See a valuable paper by Sir N. Barnaby in the *Transactions* of the Institution of Naval Architects for 1863.

conditions it is requisite to have the power of moving the helm rapidly through large angles. As an example of the advantages to be obtained by using steam steering-engines the *Minotaur* may be mentioned. With manual power, as above stated, seventy-eight men were required to steer her, and the helm was only got over to 23 degrees in $1\frac{1}{2}$ minutes, while turning the circle occupied about $7\frac{2}{3}$ minutes. With steam steering-gear two men put the helm over to 35 degrees in 16 seconds, the circle was turned in about $5\frac{1}{2}$ minutes, and its diameter was less than two-thirds that on the former trial.

In a few of the largest mercantile steamers hand steering-gear has been dispensed with, and a second steering-engine fitted with independent driving-gear, as an alternative mode of steering in case of accident, or the need of repair to the engine ordinarily at work.

Turning Effect of Rudders.—Attention will next be directed to the effect of rudders in turning ships. This is the purpose for which rudders are fitted, but the preceding remarks have been necessary in order to clear the way for the description that will now be attempted.

Suppose a ship to be advancing on a straight course and with uniform speed, the stream-line motions on either side being perfectly symmetrical; then it is known, as the result of model experiments, that the least disturbing cause will produce a departure from this balance of the stream-line motions, and cause the vessel to swerve

from her original course. Immediately after the helm begins to move over, such a disturbing cause is developed in the pressure on the rudder, the magnitude of which increases as the helm angle becomes larger. Fig. 171 shows the plan of a ship, with the rudder

(AB) put over to the angle BAD; the arrow indicates the line of action of the resultant pressure P. Let G indicate a vertical axis passing through the centre of gravity of the ship; through G draw the line HL parallel to the line of action FC of the resultant pressure on the rudder, and along HL suppose two equal and opposite forces P, P to be applied. These forces will balance one another, and therefore will not produce any change in the conditions to which the ship is subjected independently of them. By this means the single force P on the rudder is replaced by a single force P acting along HG, and a couple formed by the pressure P on the rudder and

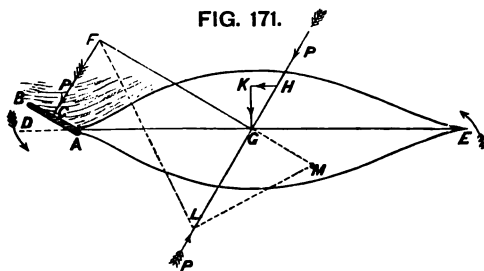

an equal force acting along LG; the arm of this couple is GF, and it evidently tends to turn the vessel in the direction indicated by the arrows at the bow and stern. The single force P acting along HG tends to produce a simultaneous motion of translation of the vessel along its line of action. This force P may be resolved into two components: if GH represents P, HK will be its component acting parallel to the keel, and KG the component acting perpendicularly to the keel. The transverse component is usually larger than the longitudinal; but it is not so important, because at each instant it has opposed to it the great force of *lateral resistance* (see p. 506), and therefore can cause but a very small speed of drift. The longitudinal component, on the contrary, may exercise a sensible effect in checking the speed of a ship while she is turning. As the rudder is put over, the value as well as the direction of P changes, and the absolute and relative values of these component forces will change; but at each instant conditions similar to those described will be in operation. It becomes important, therefore, to trace the consequent motion of the ship, and for the sake of simplicity it will be assumed that she is a steamer, the propelling force being delivered parallel to the keel-line.

Ultimately, when the rudder has been held at a steady angle for some time, the ship will turn in a path which is very nearly circular, and is usually treated as if it were a circle. Her speed will be less than it would be if she were steaming on a straight course with the same engine-power, and her ends will be turning about the vertical axis passing through the centre of gravity, with a nearly uniform motion, or angular velocity. Before this condition could have been reached, however, there must have been a period during which the angular velocity was gradually accelerated up to its uniform value, while the headway was being checked, and before the lateral drift had supplied a resistance balancing the component of the rudder pressure and the centrifugal force. It will be well, therefore, to glance at this period of change before considering the case of uniform motion.

As soon as the rudder is put over, an unbalanced couple will be brought into operation, and the ship will begin to acquire angular velocity. At first this velocity will be very small; and as the resistance offered by the water to rotation varies very nearly as the *square* of the angular velocity,* that resistance is of little importance in the earliest stages of the motion. The initial values of the

* Analyses of numerous turning trials made with the *Warrior* enable us to state that in her case the resistance varied with a power of the angular

velocity almost identical with that deduced from the experiments made by Mr. Froude on frictional resistance.

angular acceleration will therefore chiefly depend upon the ratio which the moment of the couple bears to the moment of inertia of the ship about a vertical axis passing through the centre of gravity (G, in Fig. 171). That moment of inertia is determined by multiplying the weight of every part of the ship by the square of its distance from the axis of rotation; and the moment of inertia would evidently be much increased if heavy weights were carried near the extremities instead of being concentrated amidships. Hence, with a certain rudder area put over to the same angle in the same time, in two ships similar to another in outside form and immersion, but differing in their moments of inertia, the ship having the less moment of inertia will acquire angular velocity more quickly than her rival. Moreover, it will be evident that a ship of which the rudder can be put over quickly to its extreme angle will acquire angular velocity more rapidly than she would with the same rudder put over slowly. As the angular velocity is accelerated, the moment of the resistance increases, exercising an appreciable effect upon the acceleration; and finally a rate of motion is reached for which the moment of the resistance balances the moment of the couple due to the corresponding pressure on the rudder, the angular velocity then becoming constant. Simultaneously with this acquisition of angular velocity, a retardation of headway will have taken place, and carried with it some change in the pressure on the rudder, which will also be affected by the considerations mentioned above; the balance between the lateral resistance and the other forces named above will also have been established.

Four features, therefore, chiefly affect the readiness of a ship to *answer her helm*: (1) the time occupied in putting the helm hard over; (2) the rudder pressure corresponding to that position; (3) the moment of inertia of the ship about the vertical axis passing through the centre of gravity; (4) the moment of the resistance to rotation. Only the first and second of these can be much influenced by the naval architect; their importance has already been illustrated from the turning trials of the *Minotaur*. The moment of inertia is principally governed by the longitudinal distribution of the weights in the ship; in arranging these weights, considerations of trim, convenience, and accommodation are paramount. The moment of resistance depends upon the form and size of the immersed part of the hull, and is especially influenced by the fine parts of the extremities. In merchant steamers of great length the deadwood forward is often cut away to a considerable extent, in order to save weight at the extremities, simplify construction, and assist in turning the vessels at low speeds. The after deadwood in such cases is usually retained. In certain torpedo vessels and cruisers—the

Polyphemus being a notable example—the deadwood both forward and aft is cut away, and the vessels have proved very handy. In torpedo-boats and torpedo-gunboats it is usual to leave the forward deadwood, but to cut the after away, as illustrated in Figs. 168 and 169. This is advantageous, no doubt, in swift vessels of shallow draught, especially in the reduction of the space required for turning when going ahead at full speed. Experiments have been made which prove that the retention of the forward deadwood, or additions thereto, will effect such a reduction. On the other hand, when going astern the conditions are reversed, as might be expected, and a boat with large forward deadwood is less handy than one with a less area of flat surface forward. A very interesting experiment made by Lieutenant Hovgård on two Danish torpedo-boats (mentioned at p. 181) illustrates this. The boats were 137 feet long, and of 110 tons displacement; alike in all respects, except that one of them was fitted with an external vertical keel, or “ventral fin,” placed well forward, having an area of about 60 square feet. At 18 knots speed, the boat so fitted turned in a circle of 500 feet diameter, 60 feet less than the diameter for the sister boat. When going full speed astern, the boat fitted with the “fin” forward turned in a circle of 790 feet diameter, and her sister boat in one of 420 feet diameter. Under these circumstances the balance of advantage was clearly in favour of the latter boat, and the experiment is conclusive against the proposal to add to the forward deadwood in order to increase handiness in war-ships. Power of command ahead is no doubt of the greatest importance, but steerage with sternway is also important. Another consideration which must not be overlooked is, that when the finer portions of the deadwood are cut away to a considerable extent the resistance to rolling motions is diminished. In sailing vessels the lateral resistance would also be reduced, and leeway increased. Modern types of yachts have the deadwoods cut away greatly, but they are also of very deep draught, and thus combine considerable lateral resistance with great handiness under sail.

Closely associated with this readiness to answer the helm, or to acquire angular velocity, are the conditions which control the decrease of that velocity when a vessel has had her head brought round to a new course upon which it is desired to keep her. The greater the ratio of the moment of resistance to the moment of inertia, the more rapid will be the rate of extinction of the rotation; and, conversely, the greater the ratio of the moment of inertia to the moment of resistance, the slower will be the rate of extinction. Both moment of inertia and moment of resistance must be considered; and possibly the helm may be brought into action to assist in keeping the ship on her new course. Deep draught, considerable length,

fine entrance and run, deep keels, and other features which lead to an increased resistance to rotation, are not, therefore, altogether disadvantageous. They make a vessel slower in acquiring angular velocity, but they enable her to be kept well under control. Shallow-draught vessels are not unfrequently less manageable by the helm than deep-draught vessels; they quickly acquire angular velocity, and turn rapidly, but have comparatively small resistance in proportion to the moment of inertia, and are not easily kept on a new course, "steering wildly" in some cases, as a sailor would say. In such cases the addition of a deep keel and consequent increase of resistance to rotation and drift often greatly improves the steerage. Vessels of the circular form possess considerable moment of inertia, whereas nearly the whole resistance to rotation must be due to skin friction, and can be but of moderate amount. It might, therefore, be expected that these vessels would be difficult to check and keep on any desired course if they had been turned through a considerable angle and acquired a good angular velocity. It has, in fact, been asserted that the vessels are "ungovernable" under the action of their rudders; and their designer, Admiral Popoff, in replying to these criticisms, dwelt upon the manœuvring power obtained by the unusual number of their propellers, not claiming for them great handiness under the action of the rudders alone.*

It is a matter of common experience that ships which are perfectly under control in deep water steer wildly and require careful watching when they are navigating in very shallow water, and have their keels only a few feet clear of the bottom. In view of the remarks made in Chapter XI., on the influence of depth of water on resistance, it will be readily understood why the manœuvring qualities should also be affected. Moreover, under these circumstances vessels usually proceed at very slow speeds. For example, when passing through the Suez Canal, a low speed is insisted upon. The turning power of the rudder for a given helm angle is then reduced, and consequently the management of a ship is made more difficult than at higher speeds, while the shallowness of the water and the limited size of the channel increase the difficulty of management.

Experienced seamen declare that, when a steamer has headway, and the helm is put over, "the head appears to turn comparatively slowly, while the stern swerves suddenly to the right or the left." † This is quite in accordance with theoretical considerations. Professor Rankine many years ago published an investigation for the instan-

* See a lecture delivered at Nicolaieff in 1875, of which a translation appeared in *Naval Science*.

† See an interesting article, "On Sternway," by Captain Allen, R.N., in *Naval Science* for 1875.

taneous axis about which a ship should begin to turn when the rudder was first put over, on the supposition that the first action of the rudder might be regarded as an *impulse*. His construction for this instantaneous axis is shown in Fig. 171. The length GL represents the "radius of gyration" of the ship about the vertical axis passing through the centre of gravity G; and is measured on the line HL drawn perpendicular to the arm FG of the couple.* Join FL, and produce FG to M; draw ML perpendicular to FL, meeting FM in the point M; that point will be the "instantaneous axis" about which the *first* movement of the ship takes place, and M may lie considerably before the centre of gravity. To determine the instantaneous motion of any point in the ship, it is only necessary to join that point with M, and to describe a small circular arc with M as centre. It will be understood that this construction only applies to the motion of the ship at the *first moment* after the rudder is put over.

Purely theoretical investigation does not enable one to lay down the path traversed by the centre of gravity of a ship in turning from a straight course under the action of her rudder. The equations of motion can be framed in general terms; but our knowledge respecting the resistance offered by the water to the motion of the ship is not sufficient to enable all the quantities to be expressed, and a complete solution reached. Hence it becomes necessary that the problem should be attacked by actual experiment, and that careful observations should be made of successive positions occupied by a ship so that the path traversed might be subsequently plotted. In such determinations of the path of a ship it is convenient (1) to take the original straight course as the *line of reference*, from which to measure the angles turned through by the keel-line of the ship in specified times; (2) to take as an *origin of co-ordinates* the position of the centre of gravity of the ship on her straight course at the instant when the helm begins to move over; (3) to note the path of the centre of gravity while the ship turns. This centre in most ships is situated very near the middle of the length; so that the path of the latter point will serve for all practical purposes, as the path of the centre of gravity. With these means of reference, if the place of the centre of gravity is fixed at frequent intervals of time, a curve can be drawn through the points obtained, and will be the path required. If simultaneous observations are made of the angles through which the head of the ship has turned from her original course, the instantaneous positions of the keel-line are known for a series of positions, and its instantaneous inclination to the cor-

* See p. 150 for an explanation of the term "radius of gyration."

responding tangents to the path of the centre of gravity can be ascertained.

Until questions of steam tactics for war-ships became important, and the employment of ships as rams occupied attention, no attempts appear to have been made to determine accurately the path traversed. In recent years, however, many such observations have been made both in the Royal Navy and in foreign navies; their great practical value is now generally recognized, and additions are rapidly being made to our knowledge.

The French experimental squadrons of 1864–66 were subjected to very exhaustive turning trials, and the observations made would have sufficed to determine the complete motions of the ships from their straight course; but this was not done, attention being chiefly devoted to the determination of the circular path in which each ship turned after her motion had become uniform. Since then it has been recognized that for tactical purposes it is more important to know what is the nature of the path traversed immediately after the helm is put over, and where the ship will be placed when she has turned through the first 90 degrees, as well as her position when she has turned through 180 degrees and reversed her course.

One of the earliest proposals for determining accurately the motion of a ship in turning was made by M. Risbec of the French Navy, and applied by him to a small vessel, the *Elorn*, at Brest, in November, 1875. This method is, we believe, still generally used in

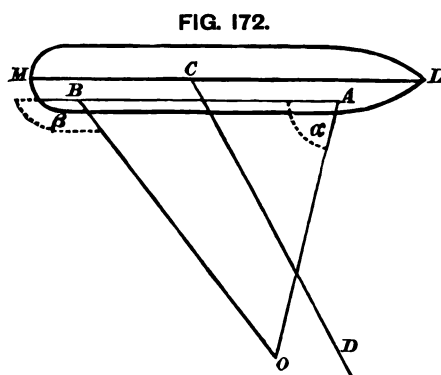

the French Navy, and is exceedingly well adapted for its purpose.* In its main features it resembles methods of observation previously known, and occasionally applied, and a brief account of it may be of interest. Two observers are stationed at a considerable distance apart on a line parallel to the keel-line of the ship, as indicated by the points A and

B, Fig. 172. They are each furnished with a simple sighting instrument (or azimuth instrument), and at frequent intervals of time, at a given signal, observe simultaneously, and record the angles α and β made with the line AB by their respective lines, of sight to a floating object, O, placed within the path traversed by

* See vol. xlix. of the *Revue Maritime* for further particulars.

the vessel. This object may be anchored if there is  tide or current, but otherwise may be a simple buoy or boat with a flagstaff. A large number of observations being made, a series of triangles, such as AOB, can be constructed, the length AB being constant, and the errors of observation can be eliminated by a careful comparison and analysis of the results. To complete the plotting of the path of the ship, it is necessary to fix the position of any such triangle as AOB; this is done by a third observer, C, who notes and records the bearings of a fixed and distant object, with reference to the keel-line, each time that the signal is given for the first two observers to note the bearing of O from their stations. The angle LCD is that which he has to determine in each case, and this may be done in other ways than that named above.

Another very excellent series of trials was made on the *Thunderer* at Portland in 1877. The details of the observations and their principal results will be found in the Appendix to the Report of the *Inflexible* Committee. In some respects these trials were more exhaustive than any previously made, and the utmost care was taken to check the several observations and eliminate errors. They well deserve the study of all who are interested in the turning trials of ships, and have been issued to H.M. ships by the Admiralty for the information and guidance of officers in the Royal Navy. Since the completion and publication of the results of these turning trials in the *Thunderer*, very many similar trials have been carried out in H.M. ships. Admiralty instructions have been issued for guidance in making the necessary observations.* More exact information has thus been obtained and recorded respecting the paths traversed by ships in turning through the first quadrant and reversing their course than was formerly available.

Before these observations were systematized it was the established practice to make turning trials of all new ships, primarily for the purpose of thoroughly testing the efficiency of the rudders and steering gear. Measurements were also made of the diameters of the "circles" in which ships turned, in order to obtain a rough idea of their relative handiness. These trials were made in smooth water and light winds, with helms hard over to port and starboard, and with ships running at full or half power. Careful note was taken of the times occupied in putting the helms over, in reversing the course, and completing

* These instructions embody methods of observation agreeing in principle with those above described. They were chiefly based on work done by Admiral Colomb, who has fully described them, and given much interesting information

respecting results of turning trials, in a paper published in the *Transactions* of the Institution of Naval Architects for 1886. See also a paper by the author published in the *Journal* of the Royal United Service Institution for 1879.

the circles. For twin-screw ships, or other ships with duplicate propellers, additional trials were made with one propeller only at work, and with one propeller turning ahead and the other astern. Sometimes the turning trials were extended to other speeds, or to angles of helm ranging from "hard-over" to very small angles. Much information was thus gained, but the actual path of a ship in turning was not determined, and the assumption that she turned in a circle was known to be inaccurate. These preliminary (or constructors') trials are still continued, and necessarily so; but they no longer stand alone as records. Continued experience in the management of ships during service at sea has always enabled commanding officers to obtain an intimate knowledge of the turning powers of their ships under varying circumstances of wind, sea, speed, and helm angle. Fleet manœuvres necessarily require a knowledge of the manœuvring powers of the individual vessels which have to work together. In all these ways information is acquired, and under the regulations the facts are recorded in the "Ship's Books" issued to H.M. ships, for the information of officers who may succeed to the command. For many ships, diagrams are also inserted in the "Ship's Books," showing the paths traversed in turning, or the critical points on those paths, giving the positions of the ships when they have turned 90 and 180 degrees respectively from their original course, or completed 360 degrees and resumed that course.

— The case of the *Thunderer* may be taken as fairly representative of war-ships possessing good manœuvring power, and it will be interesting to trace her movements from the moment the helm is put over, until she settles into uniform motion. Fig. 173 will enable this to be done.

The path of the ship when she begins to turn away from her straight course will be seen to be spiral, and not circular; consequently when she has turned through 360 degrees she is found (at E) somewhat within the line AC of her original course. As she acquires angular velocity, so her bow turns *inwards* from the tangent to the path of her centre of gravity, and the angle between this tangent and the keel-line, or "drift-angle," (*angle de dérive*) as it is termed, gradually increases. Owing to the existence of this drift-angle, the thrust of the propellers, when a ship is turning, is delivered at each instant athwart her course; and to this must be mainly attributed the loss of speed which takes place, and which is commonly attributed to the "drag" of the rudder. Her angular velocity meanwhile undergoes rapid acceleration; and, as she turns, centrifugal force comes into operation, and the ship heels from the upright. By degrees these transitory conditions give place to uniform conditions, if the helm is kept at a constant angle and the engines at a nearly

TURNING TRIALS OF *THUNDERER*.

	Time.	At end of time.	
		Speed of ship.	Angular velocity per second.
To put helm over 31°	seconds. 19	knots. 10·4	0° 20'
To turn ship's head 45°	56	9·25	1° 18'
" " 90°	89	8·3	1° 18'
" " 135°	123	7·75	1° 15'
" " 180°	159	7·5	1° 12'
" " 360°	320	7·14	1° 6½'

At 360 degrees the turning motion had become practically uniform. It appears that with steam steering gear similar conditions of uniform motion are usually reached as soon as, or sooner than, they were reached in the *Thunderer*. With manual power only, similar conditions are sometimes not reached until a vessel has made two or more circuits. When a ship has turned through 90 degrees, her motion will not be uniform, and her path is still spiral. Hence it is desirable that a commanding officer of a war-ship should determine by actual observation, at different speeds and with different helm angles, how the ship would be placed, in relation to her course and position at the instant when the helm was put down, after she has turned through 90 degrees.

When the motion of a ship in still water has become *uniform*, her centre of gravity will move in a circular path, and all other points in her will move in concentric paths. The fore end of the keel-line of the ship will be turned within the tangent to the path of the centre of gravity, making a drift-angle with it of greater or less amount. In Fig. 174, O represents the centre of the circle; G_1GG_2 the path of the centre of gravity; G the instantaneous position of that point, and TGT_1 the tangent at G; AB is the keel-line; BGT_1 is the drift-angle for G. From O a perpendicular OP is let fall on AB. Then the tangent to the circular path described by the point P coincides with the keel-line; consequently there is no drift-angle at P, and it is sometimes termed the "pivoting point," because, to an observer on board, the ship seems to be turning about it. It will be understood, of course, that O is the true centre of motion for the ship in turning. In the *Thunderer* the pivoting point P varied from 67 to 103 feet before the centre of gravity, or from 80 to 40 feet abaft the bow. As the speed and drift-angle increased, the point P moved forward. Cases may occur where the drift-angle at the centre of gravity is so considerable that the pivoting point lies before the bow, and is found on the keel-line produced. By means

of a construction similar to that shown for the centre of gravity G , the drift-angle can be determined for any other point on the keel-line. Take, for example, the extreme after-end B : join OB , draw QB perpendicular to OB , and the angle DBQ is the drift-angle at B .

FIG. 174.

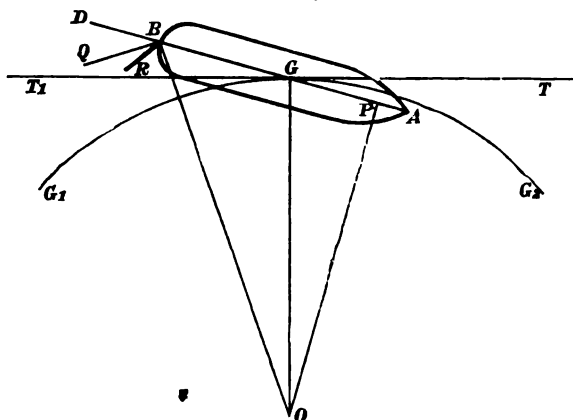

The angle DBQ is greater than the drift-angle BGT_1 , for the centre of gravity; and it will be obvious that, for all points lying between B and the pivoting point P , the drift-angle will remain of the *same sign*, but decrease in value as the distance of the point under consideration from P diminishes. At P the drift-angle has a zero value, in passing through which it changes sign, and for all points lying before P the drift-angles have *negative* values, as compared with the angle BGT_1 . That is to say, if a point such as A is taken, lying on the fore side of P , and OA is joined, the line drawn through A perpendicularly to OA , representing the tangent to the circular path of the point A , will lie on the other side of the keel-line AB , from that on which the tangent GT_1 is situated.

The value of the drift-angle measured at the centre of gravity varies in different vessels, and also varies in the same vessel under different conditions of speed and helm-angle. In the *Thunderer* experiments with a constant helm-angle, and practically a constant time for putting the helm hard over, the drift-angle varied from $5\frac{1}{2}$ degrees at 8 knots to $9\frac{1}{2}$ degrees at 11 knots. In the *Iris*, under similar conditions, the variation in drift-angle was only from $6\frac{1}{2}$ degrees at 9 knots to 7 degrees at $16\frac{1}{2}$ knots. In some of the experiments made with French ships, drift-angles from 16 degrees to 18 degrees have been reached. Further experiments are needed in order to determine the law of variation, but so far as can be seen at present, the drift-angle becomes greater as the area of rudder and the angle of helm (up to 45 degrees) are increased, speed being con-

stant; and also sometimes increases with increase in speed, other things remaining the same.

As a consequence of the drift-angle, the bow and stern of a ship revolve in circles of different diameters when the motion has become uniform. In the *Thunderer* this difference varied from 60 to 100 feet on a mean diameter of 1300 feet, the stern, of course, moving in the larger circle. In the French ironclad *Solferino*, the diameter of the circle swept by the stern exceeded that swept by the bow as much as 40 metres on 900 metres. The larger the drift-angle the greater is this difference.

Another consequence of the drift-angle, to which allusion has already been made, is the reduction in speed sustained by a ship in turning. In several cases where the loss of speed has been accurately measured, it has been found to reach *two-tenths* to *three-tenths* of the speed on the straight course before the helm was put over. In experimental trials with small vessels, fitted with rudders of very large proportionate area, the loss of speed has been much greater, amounting it is said to 40 or 50 per cent. of the speed on the straight. In the *Delight* gunboat, the late Admiral Sir Cooper Key ascertained that when the balanced rudder was very large and it was put over to 40 or 45 degrees, the first quadrant was turned through in about 31 seconds, and the diameter of the circle was 205 feet, or only twice the length of the vessel; but the loss of speed was so considerable, due to the large drift-angle and the drag of the large rudder, that the whole circle took 2 minutes 46 seconds to perform. With an ordinary rudder of small area put over to equal angles, and about the same speed on a straight course, the first quadrant took 33½ seconds. The diameter of the circle was 225 feet, and yet the loss of speed was so much less in turning that the whole of the larger circle was completed in 2 minutes 38 seconds. This example illustrates a well-known fact in screw-ship steerage; viz. that a very large rudder-area will increase the drift-angle, and diminish the time during which the angular velocity is becoming uniform, as well as the space required for turning, but may lengthen the time.

On consideration of the facts above stated it will be seen that the motion of a ship in turning resembles that of a ship sailing on a wind, except that in the latter case the path of the centre of gravity is straight instead of being curved. At each instant the vessel moves obliquely to her keel-line. To the "angle of leeway" in the sailing ship (see p. 506) the "drift-angle" of the ship which is turning may be considered to correspond: but whereas in the first case all points in the ship are moving in parallel lines, and the angle of leeway has a constant value; in the second case (as explained above) the drift-angles for different points have different values, and

possibly different signs. This variation in the drift-angle complicates the problem, rendering difficult any general statement of the conditions which govern the flow of water relatively to different parts of the immersed surface of a ship which is turning, or the distribution of the fluid pressures. There can be no question but that, on the side of the ship most distant from the centre of her path, there will be an excess of pressure, usually styled the force of the lateral resistance. Nor can it be doubted that cases occur, wherein the pivoting point P lies before the bow, and there is a considerable accumulation of pressure on the outer or lee bow, which pressure not merely checks the speed, but assists the rudder in turning the ship. If the pivot point P lies (as in Fig. 174) between the bow and the middle of the length—as it very frequently does—the case is less simple. For points on the keel-line abaft P , there are positive drift-angles; and if small “drop-rudders,” hinged at their fore ends, were let down below the keel and left free, they would probably find their positions of rest at some angle of inclination to the starboard side of the keel-line AB . BQ in Fig. 174 may be taken as an indication of the position of rest for one such rudder. For points on the keel before P the positions are reversed: similar drop-rudders placed at any of these points would find their position of rest at some inclination to the port side of AB . These rudder-indications simply show that, in the case of which Fig. 174 is an illustration, the flow of water for points abaft P is inwards, and that there is an excess of pressure on the outer side; whereas for points before P the flow is outwards, and the excess of pressure is on the inner side of the bow. The last-mentioned excess clearly acts against the rudder; but it extends over only a small portion of the length from the bow. The excess of pressure on the outer side acts upon a more considerable portion of the length, and is probably so distributed in many cases, with reference to the centre of gravity, that its movement assists that of the rudder in turning the ship. An increase in the drift-angle, and consequent movement of the pivot point towards the bow, is likely to be accompanied by an increase in the turning power of a ship.

The same circumstances sensibly affect the flow of water at the stern, even of screw steamers, and reduce the effective helm-angle. Turning to Fig. 174, let BR represent the rudder, and BD the middle line of the ship produced. Then RBD represents the angle made by the rudder with the keel, and for motion on a straight course this would be taken as the *effective* helm-angle. For a ship turning rapidly, however, the angular motion of the stern causes the flow of water to take place very differently; and, if for an instant the helm were left free, while the angular motion of the ship continued, it would find its position of rest (or zero-pressure) at some line, such

as BQ, inclined more or less to the keel-line. The ordinary assumption is that, if OB is joined and BQ drawn perpendicular to it, BQ will be approximately the position of rest; and it has been shown that the angle DBQ is the drift-angle for B. On this assumption, therefore, the effective helm-angle is the difference between the angle made with the keel-line by the rudder and the drift-angle at the stern. This reduction may be very considerable, amounting to one-half of the apparent helm-angle. French experimentalists have endeavoured to determine the reduction exactly in some cases, and assert that it commonly reaches one-half of the apparent helm-angle; therefore practically reducing the turning effect of the rudder by nearly one-half, as compared with what the same angle of rudder with the keel would give at the first instant the helm is hard over, and before a ship has acquired much angular velocity. Further observations are needed in order to decide this matter; but it is evident that, in ships where the greatest angle of helm with the keel-line cannot be made to exceed 30 degrees a possible reduction of 10 or 15 degrees involves a very serious loss of efficiency.

Supposing the effective helm-angle and the corresponding normal pressure on the rudder to have been determined, then, when the turning motion of a steamship has become uniform, the forces acting upon her are as follows; (1) the propelling force, delivered parallel to the line of keel; (2) the pressure delivered perpendicularly to the surface of the rudder; (3) the centrifugal force acting at each instant along the radius of the circular path traversed by the centre of gravity; (4) the resistance of the water to the motion of the ship. Of these the first and third, acting through the vertical axis passing through the centre of gravity of the ship, do not tend to produce rotation about that axis. The pressure on the rudder and the lateral resistance, each exercise a powerful turning moment, and the sum of these moments must be balanced by the moment of the resistance to rotation. But while these general considerations may be stated, it is not possible, at present, to express definitely the values of either the moments of the lateral resistance or of the resistance to rotation.

Heeling of Ships in Turning.—In this connection it may be well to refer to the *heeling* which accompanies turning. The forces which tend to produce heeling are as follows:—

1. The centrifugal force acting outwards through the centre of gravity of the ship, and tending to make her heel away from the centre of the circle.

2. The lateral component of the rudder pressure, acting through the centre of pressure of the rudder and usually at some depth below the centre of gravity of the ship, tending to make her heel inwards towards the centre of the circle.

3. The lateral component of the fluid resistance on the outer side of the ship, which equals in magnitude the resultant of the centrifugal force and the rudder pressure, and acts through the centre of lateral resistance.

Fig. 175 shows the distribution of these forces in the *Thunderer*, determined from the turning trials made at Portland. Here again it is common to find the rudder pressure credited with the heeling

FIG. 175.

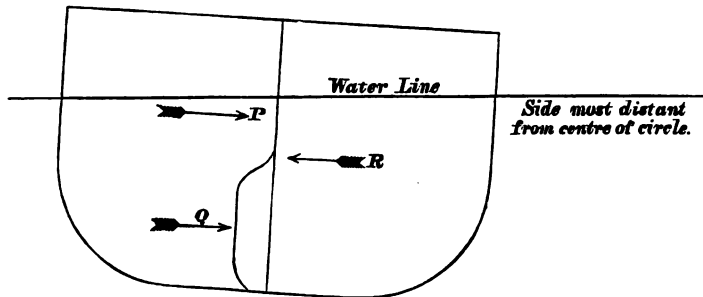

effect; whereas it may, in most cases, be neglected in comparison with the centrifugal force. A fair approximation to the angle of heel for a ship in turning is given by the following equation:—

$$\sin \theta = \frac{1}{32} \times \frac{d}{m} \times \frac{v^2}{R}$$

where θ = angle of heel,

v = speed of ship in feet per second,

R = radius of circle turned (in feet),

m = "metacentric height"; the height of transverse metacentre above centre of gravity,

d = distance of centre of gravity above centre of lateral resistance.

This expression for $\sin \theta$ should strictly be multiplied by $\cos \phi$, where ϕ is the drift-angle for the centre of gravity; but this correction may be neglected if ϕ falls below 10 degrees, as it frequently does.

In the *Thunderer*, the centre of lateral resistance was found to be from 0.43 to 0.49 of the mean draught below the water-line; probably a fair approximation for war-ships of ordinary form would be from 0.45 to 0.5 of the mean draught. From the foregoing equation it will be seen that—

The angle of heel varies—

- (1) Directly as the square of the speed of ship;
- (2) Inversely with the metacentric height;
- (3) Inversely with the radius of the circle.

Hence it is obvious that ships of high speed, fitted with steam steering gear, capable of turning in circles of comparatively small diameter, are those in which heeling may be expected to be greatest. Moderate values of the metacentric height further tend to increase the heeling. If the speed be *doubled*, the angle of heel will be about *quadrupled*, if the radius of the circle turned and the metacentric heights remain constant. In order to maintain the same angle of heel under these altered conditions of speed, the metacentric height would also have to be quadrupled; but such an increase in stiffness is clearly undesirable even if it were practicable. The following figures may be interesting:—

	Speed on straight.	Diameter of circle.	Draught.	Metacentric height.	Angle of heel.
	knots.	feet.	ft. in.	feet.	deg. min.
<i>Thunderer</i>	8·2	1340	26 3	3·12	0 52
	9·4	1250	26 1		1 11
	10·4	1240	26 1		1 14
<i>Tourville</i> (French)	15·0	2030	3 30
<i>Victorieuse</i> (French)	10·0	1290	2 0

It is important to notice that, in taking observations of the angle of heel for a ship in turning, allowance must be made for the effect of the centrifugal force upon the indications of pendulums or clinometers. The error of indication is usually in excess, and the correction is very easily made when the diameter of the circle and time of turning have been ascertained.

Although it is the rule in large ships to heel outwards in turning, after a sensible angular velocity has been attained, the first effect of putting a large rudder over quickly may be to cause the ship to heel inwards under the influence of the rudder pressure, and this heel may be the greater because of the comparatively sudden application of the force (see p. 187). This condition was actually illustrated in the *Thunderer*—the initial heeling took place *inwards*; it was of small magnitude, and was quickly succeeded by a considerable heel outwards as the ship acquired angular velocity. Cases are also conceivable, and have occurred, where the heeling has taken place inwards throughout the motion. If the circle turned has a very large diameter, if the distance d is small (as in light-draught vessels such as torpedo-boats) the inclining moment of the centrifugal force will be small, and the inclination may take place as supposed, especially if the rudder is placed low down. It is also possible, though not likely to occur in ordinary forms of ships, that the centre of gravity may fall so low down as to be below the centre

of lateral resistance ; in which case, of course, the inclination would be inwards. If bow-rudders are fitted, their tendency is to make a vessel heel outwards from the centre of the circle.

For large ships this question of heeling when turning rapidly usually has only a scientific interest. It may, however, become very important in small craft, such as torpedo-boats, when turning under the action of powerful rudders in a seaway. Cases of this kind have occurred, and the circumstances may be briefly explained. Suppose a torpedo-boat with a moderate metacentric height and a high position of the centre of gravity to be turning at speed in a circle of comparatively small diameter, this great handiness being secured by large rudders placed low under the stern of the boat. If the manœuvre takes place in smooth water, the boat heels outward under the action of centrifugal force, and the actual angle of heel will be moderated greatly by the fact that the rudder pressure acts against the centrifugal force. Conceive that the helmsman either accidentally or intentionally suddenly allows the rudder to right itself ; the steadying effect of the rudder pressure is suddenly withdrawn, while for the moment the boat continues to turn on practically the same path as before. Consequently the centrifugal force continues to act as before, and, having no rudder pressure acting against it, must produce an increased angle of heel. Moreover, the *sudden* withdrawal of the rudder pressure must cause the boat to lurch outward beyond the steady angle of heel due to the centrifugal force. It may happen, therefore, that if circumstances of this kind occur when a boat is turning among waves, whose action has set her rolling through considerable angles, they may so increase the angle of roll as to cause the boat to capsize. Such accidents have actually occurred, or been avoided with difficulty. One obvious precaution, which is now commonly adopted, is to fit simple mechanical arrangements on the steering gear by means of which the rudder can only be righted intentionally and very gradually. When this is done there can be no sudden loss of the steadying effect of the rudder pressure. Further, the gradual "easing-up" of the helm necessitates a reduction in the angular velocity, and a corresponding decrease in the centrifugal force. In this way serious lurching outward can be avoided.

Ships may obviously change trim when turning under the action of their rudders. Such changes are, however, scarcely appreciable in most cases, and never have any practical importance.

Deductions from Turning Trials of Ships.—From the records of turning trials of war-ships many interesting deductions may be made. The following are amongst the more important and practically useful :—

1. The path traversed by the centre of gravity of a ship while she turns from a straight course through 180 degrees—that is, reverses her course—is usually more or less spiral, and not a circular arc.) Allusion has already been made to the principal circumstances which influence the form of this part of the path. 'For tactical purposes two points on it are of the greatest importance: viz. the position of the ship when she has turned through 90 degrees, and her position when she has reversed her course.' The perpendicular distance between this reversed course and the original course is termed the "tactical diameter" (*diamètre d'évolution*). But its determination does not fix the space required for turning; because it leaves unknown the distance which the ship advances parallel to her original course from the instant when her helm is put over to that when her head has swung through 90 degrees. In Fig. 173, for instance, let A be the position of the ship when the helm began to move; B her position when 90 degrees have been turned through. Draw AC as a prolongation of the original straight course, and BC perpendicular to AC; then AC is the distance required, or, as it has been termed, the "advance" of the ship. This may become very considerable under some circumstances, in proportion to the tactical diameter, or to the simultaneous movement, sometimes termed the "transfer," in a direction at right angles to the original course.* For example, in the *Thunderer* the tactical diameter was 1320 feet, the "advance" to the 90 degrees position was 1000 feet, and she was then at 700 feet perpendicular distance from her original course. In the *Iris*, at 10 knots the tactical diameter was 2300 feet, the advance for 90 degrees was about 1470 feet, and she was then 1040 feet distant from her original course. It will be noted that when the head of a ship has swung through 90 degrees, the tangent to the path of the centre of gravity will have only turned through 90 degrees less the drift-angle at that instant, which will have different values in different ships, and under varying circumstances in the same ship. The ratio of the advance to the transfer at the 90 degrees position will also vary greatly in different ships. In shallow-draught vessels, and more especially in those of high speed, such as torpedo-boats, the momentum in the direction of the original course, which the vessels have at the instant when the helms are put down, is not quickly destroyed by the lateral resistance, and they "sheer off" in turning, the advance having a considerable relative value.

2. After the turning motion of a ship has become uniform, the

* These terms—advance and transfer—were suggested by Admiral Colomb. They express very simply measurements which in mathematical language would

be styled the "co-ordinates" of the centre of gravity at any time, referred to the axes CA and CB.

path of her centre of gravity is practically a circle having a diameter somewhat smaller than the tactical diameter. The French use the term *diamètre de giration*, for this circle; *final diameter* has been proposed as the English equivalent. In the *Thunderer* trials, the mean ratio of the final to the tactical diameter was about 100 : 105. In trials with the *Iris*, at speeds from 9 to 14 knots, nearly the same mean ratio held good. In trials with the French armoured corvette *Victorieuse*, the ratio was about 100 : 117.

3. Most of the turning trials hitherto made on new ships—the constructors' trials as they have been termed above—may be supposed to give approximations to the *tactical diameters* of the ships. For war-ships, the following results have been obtained.* With manual power and ordinary rudders the diameter of the circle for large ships has been found to vary between six and eight times the length of the ships. For small ships, wherein manual power suffices to put the helm over rapidly and the speed is low, the diameter falls to three or five times the length. For swift torpedo-boats, with ordinary rudders, manual power only at the helm, and very small angles of helm, the diameter of the circle for full speed has reached about twelve times the length, and for half speed about four or six times the length. With manual power and *balanced* rudders, the diameter for large ships has been reduced to four or five times the length, and nearly equal results have been obtained with ordinary rudders worked by steam or hydraulic steering gear. About three times the length is the minimum diameter attained in large war-ships turning under the action of their rudders. In the despatch-vessel *Iris*, with steam steering gear, the diameter of the circle was from eight to nine times the length, which is to be explained by her relatively small rudder, and extremely fine form. In the *Shah* swift frigate with steam steering and a larger rudder-area, the diameter of the circle varied from five to six times the length. Corresponding facts as to merchant ships are not numerous; but it would appear that diameters from seven to eight times the length are not uncommon with steam steering gear and good helm-angles. In these ships great handiness is not sought for moderate rudder-areas are common, and it is chiefly desired to have the vessels well under control. Larger rudder-areas might be advantageously adopted, no doubt, now that steam steering gear is so extensively used.

4. The propellers of the ships were working at *full speed* when the

* For details see Admiral Boutakoff's *Tactiques Navales*, M. Dislere's *Marine Cuirassée*, Admiral Bourgois' *Études sur les Manœuvres des Combats sur Mer*, M. Lewal's *Principes des Évolutions*

Navales, Admiral Colomb's paper in the *Transactions* of the Institution of Naval Architects for 1886, and the author's paper, "On the Turning Powers of Ships," mentioned above.

preceding results were obtained. But it appears that differences of speed do not greatly affect the diameters of the circles, although they affect the time of turning, so long as the helm-angle remains constant, and about the same time is occupied in putting the helm over. With steam steering or with balanced rudders these conditions may be fulfilled, and the diameter remains nearly constant in smooth water and light winds. In the *Thunderer*, for example, at speeds from 8 to 10 knots, the diameter only varied from 1400 to 1320 feet. In the *Iris*, for speeds varying from 9 to 14 knots, the diameter varied only from 2300 to 2400 feet; at the still higher speed of 16½ knots it was nearly 2700 feet, but this was a single trial. In the *Bellerophon*, with balanced rudder and manual power, the diameter of the circle at 14 knots was 1680 feet, and at 12 knots 1650 feet. In large ships, with manual power only available at the steering wheels, a shorter time suffices to put the helm over, or larger angles can be reached, at lower speeds, and then the diameters of the circles are decreased. In the *Warrior*, for example, while the diameter of the circle at 14 knots was 2340 feet, at 12 knots it was 1580 feet only.

5. The time occupied in putting the helm hard over exercises a considerable influence on both the time occupied in turning the circle and upon its diameter; but more particularly affects the latter. The case of the *Minotaur*, mentioned on p. 670, is a good illustration of this, and as another the trials of the sister ships *Hercules* and *Sultan* may be cited. The latter had steam-power applied to her balanced rudder, which could be put over in about half the time occupied by manual power in the *Hercules*. The diameter of the circle in the *Hercules* was nearly twice as great as that for the *Sultan*; the time of turning for the *Sultan* was rather less than that for the *Hercules*, although the speed was half a knot less. It will be evident that the distance traversed by a ship in turning will depend upon the rapidity with which her uniform angular velocity is acquired, the rate of that velocity, and the check to her headway, all of which will be affected by the time occupied in putting the helm up. By means of balanced rudders or steam steering, the mean angular velocity, or speed with which the ends of a ship turn relatively to the middle, has in some cases been almost doubled as compared with the results obtained with ordinary rudders and manual power.

6. Other things remaining unchanged, an increase in the rudder area is most influential in diminishing the space traversed in turning; and this diminution may be of the greatest value to a war-ship intended to act as a ram. This point has been illustrated by the performances of the *Sultan* and *Hercules* with their rudders acting as simple

balanced rudders, and with the after parts of the rudder alone at work. Further, it appears that increased rudder-area and helm-angle may, in some cases, check the headway so much as to produce no greater turning effect than, if so great as, would be produced by smaller rudders and less helm-angles. In the experiments on the gunboat *Delight*, with balanced rudders of different sizes, mentioned on p. 682, it was found that the largest rudders diminished the space traversed in turning, made the time of turning the first quadrant less (that is, enabled the full angular velocity to be more quickly attained), but somewhat increased the time of completing the circle, in consequence of the greater check to the headway.

7. For the same ship, with the same angle of helm and about the same time occupied in putting the helm over, the time occupied in turning the circle appears to vary nearly inversely as the speed. Take, for example, the following results for the *Warrior* and *Hercules*:—

<i>Warrior.</i>			<i>Hercules.</i>			
Speeds.	Times of turning circle.		Speeds.	Times of turning circle.		Products of speeds by times.
knots.	min.	sec.	knots.	min.	sec.	
3	28	46	6	9	32	57.2
6	15	30	8	7	21	58.8
9	10	40	10	6	22	63.6
12	8	45	12½	4	28	54.2
14½	7	21	14.7	4	0	58.8

The following results for the *Thunderer* are also interesting; they relate to the second circle turned when the motion had become uniform:—

Speeds.	Times of turning circle.		Products of speeds by times.
knots.	min.	sec.	
5.83	7	6	41.4
6.87	5	38	38.7
7.14	5	24	38.5
7.24	5	16	38.1

This approximate rule will be seen to rest upon the facts that

the diameters of the circles at different speeds are practically equal under the assumed conditions, and that the loss of speed in turning bears a fairly constant ratio to the speed on a straight course. It may be of some service in estimating the time that will be occupied in turning at any selected speed, when the performance of a ship at some other speed is known; but it clearly cannot be used with safety except the fundamental assumptions are fulfilled.

8. Up to helm-angles of 40 degrees, the turning power of the rudder has been found to increase with increase in the helm-angle. Theoretically, if the streams impinged upon the rudder parallel to the keel-line, and the effective pressure on the rudder varied with the sine of the angle of inclination, 45 degrees would be the angle of maximum turning effect. This may be seen very easily. Using the notation of p. 670, the moment of the pressure (P) on the rudder will vary very nearly as the product $P \times GA \cos a$ (Fig. 171); the distance AC from the axis to the centre of effort of the rudder being very small as compared with AG. Also (as explained on p. 665) the pressure (P) equals the product of the normal pressure (P_1) by the sine of the angle a . Hence, approximately—

$$\left. \begin{aligned} \text{Moment of pressure on} \\ \text{rudder about G} \end{aligned} \right\} &= P \times GA \cos a \\ &= P_1 \sin a \times GA \cos a \\ &= \frac{1}{2} P_1 \sin 2a \times GA.$$

This will have its maximum value when $\sin 2a=1$ and $a=45$ degrees. Balanced rudders are usually arranged so that they can be put over to 40 degrees; ordinary rudders are seldom put over beyond 35 degrees, and with manual power only, the angle seldom exceeds 25 degrees in large screw steamers.

Experience fully confirms these conclusions, as will be seen from the following examples. The *Delight* gunboat behaved as under, when the helm-angle alone was varied:—

Helm-angle.	Times of turning full circle.		Diameter of circle.
degrees.	min.	sec.	feet.
10	3	52	615
20	3	18	405
30	2	57	275
40	2	47	205

In trials conducted with the floating battery *Terror* the results were no less striking—

Helm-angle.	Times of turning full circle.	
degrees.	min.	sec.
10	6	19
20	5	28
30	5	1
40	4	42

Lieutenant Coumes, of the French Navy, gives the following results for the ironclad corvette *Victorieuse* for an initial speed of about $12\frac{1}{2}$ knots:—

Helm-angle.	Times of turning full circle.		Diameter of circle.
degrees.	min.	sec.	metres.
7	9	48	1060
14	6	50	933
21	5	50	750
27	5	20	572
$32\frac{1}{2}$	5	20	465

In practice, as has been shown above, it may happen that, with large rudder-areas, the *least time* in turning through the complete circle does not occur with the largest angle of helm, although the least diameter of circle does then occur. But for tactical purposes the first quadrant or first half-circle is more important usually than the complete circle, and within these limits large rudders at large angles economize both space and time. Moreover, in such a case the commanding officer can use his large rudder at a somewhat less angle if he wishes to turn completely round in the least time, or at the full angle, if economy of space is more important.

Determination of Rudder-Areas.—Attention will next be directed to some matters of practical interest relating to the determination of the areas and forms of rudders, and the helm-angle to be adopted in new ships. It will be convenient if the last-named problem is taken first. From the remarks made above it will be evident that, so far as the steering effect is concerned, a possible helm-angle of 40 to 45 degrees would be advantageous, or even a greater angle, if regard is to be had to the reduction of the effective helm-angle which takes place in turning (see p. 683). Other considerations come in, however, and affect the decision. It may be very difficult with certain

forms of stern to secure a large angle of helm, even when all care is taken and recourse had to various mechanical devices. When manual power only was used in the great majority of ships with ordinary rudders, it became important to decide between the relative advantages of area and helm-angle which were possible with a certain power available at the tiller-end. Mr. Barnes drew attention to this matter some years ago, basing his investigation on the old law, that the effective pressure on the rudder varied as the *square* of the sine of the angle of inclination.* Adopting the law of the sine, it may be interesting to make a similar comparison between a narrow rudder held at a certain angle by a given force at the tiller-end, and a broader rudder of equal depth held at a smaller angle by the same force. Let it be supposed that the rudders are of similar form, so that their areas and the distances of their centres of effort (C, Fig. 170) from the axis will be proportional to the extreme breadths, B_1 and B_2 ; then for the narrow rudder we may write—

$$\text{Area of rudder} = S_1 = \text{depth of rudder} \times B_1 \times f = f \cdot d \cdot B_1,$$

where f is some fraction of the breadth applicable to both rudders. Using the notation previously adopted, α_1 being the helm-angle—

$$\begin{aligned} \text{Pressure on rudder} &= P_1 \cdot S_1 \cdot V^2 \sin \alpha_1 \\ &= P_1 \cdot f d \cdot V^2 \cdot B_1 \sin \alpha_1 = C_1 \cdot B_1 \sin \alpha_1. \end{aligned}$$

$$\left. \begin{array}{l} \text{Moment of pressure about} \\ \text{axis of rudder} \end{array} \right\} = \begin{cases} \text{pressure} \times AC \\ = C_1 \cdot B_1 \sin \alpha_1 \times r \cdot B_1 \\ = r \cdot C_1 \times B_1^2 \sin \alpha_1. \end{cases}$$

If S_2 be the area of the broad rudder, α_2 its angle, B_2 its breadth, similar expressions will hold for it, the constants C_1 and r being identical. Hence, in order that the moments of pressure about the axes of the rudders may be equal, we must have—

$$C_1 r \cdot B_1^2 \sin \alpha_1 = C_1 r \cdot B_2^2 \sin \alpha_2$$

whence—

$$\frac{\sin \alpha_1}{\sin \alpha_2} = \frac{B_2^2}{B_1^2}$$

The last equation succinctly expresses the relation which must hold when the force applied at the tiller-end is the same in both cases.

For the turning effect of either rudder, we may take—

$$\text{Turning effect} = \text{pressure} \times AG \times \cos \text{ of helm-angle};$$

and, since AG is the same for both rudders—

$$\frac{\text{Turning effect of narrow rudder}}{\text{Turning effect of broad rudder}} = \frac{B_1 \sin \alpha_1 \cos \alpha_1}{B_2 \sin \alpha_2 \cos \alpha_2} = \frac{B_2 \cos \alpha_1}{B_1 \cos \alpha_2}$$

* See his paper in the *Transactions* of the Institution of Naval Architects for 1864.

Suppose, as an example, the narrow rudder put over to 40 degrees and the broad to 20 degrees by the same force on the tiller-end—

$$B_2 = B_1 \sqrt{\frac{\sin 40^\circ}{\sin 20^\circ}} = B_1 \sqrt{\frac{0.643}{0.342}} = 1.37 B_1.$$

$$\begin{aligned} \frac{\text{Turning effect of narrow rudder}}{\text{Turning effect of broad rudder}} &= 1.37 \frac{\cos 40^\circ}{\cos 20^\circ} \\ &= 1.37 \times \frac{0.766}{0.94} = 1\frac{1}{3} \text{ (nearly).} \end{aligned}$$

The broad rudder, with an area 37 per cent. greater than the narrow one, has therefore less turning effect by about 11 per cent. If the ship had sail-power as well as steam, the smaller area of the narrow rudder would have the further advantage of checking the headway less when the ship was manœuvring under sail alone.

It will be seen, on reference to p. 666, that in his multiple-bladed rudders, M. Joëssel endeavoured to associate large effective rudder-area with comparatively small longitudinal dimensions in order to reduce the force required at the tiller-end, and he based his procedure on reasoning similar to that above.

Various rules have been used for determining the *area* of the rudder for a new ship. For sailing ships of former types, having lengths about $3\frac{1}{2}$ to 4 times the beam, the extreme breadth of the rudder was commonly made *one-thirtieth* of the length, or *one-eighth* of the breadth of the ship. The mean breadth of a rudder commonly varied between seven-tenths and nine-tenths of the extreme breadth. For steamships a similar rule is used, the extreme breadth of the rudder being made from *one-fortieth* to *one-sixtieth* of the length. Mr. Scott Russell proposed to make a slight modification of this rule, the extreme breadth of the rudder being one-fiftieth of the length *plus* 1 foot. Another mode, commonly used for English and foreign ships of war, is that by which the area of the immersed part of the rudder is proportioned to the area of that part of the longitudinal middle-line section of the ship situated below the load-line; the same area which is made use of in determining the "centre of lateral resistance" for sailing ships (see p. 520). As the area of this section depends upon the product of the length of the ship into the mean draught, while the rudder-area depends upon the product of its breadth into the draught of water aft, it will be seen that this rule agrees in principle with the old rule. In sailing ships, the rudder area was often about *one-thirtieth* or *one-fortieth* of the area of the middle-line plane; in the screw line-of-battle ships and frigates, similar values were common; from *one-fortieth* to *one-fiftieth* are common values in ironclad ships of moderate length with ordinary

rudders. In the long ironclads of the *Warrior* and *Minotaur* classes, the rudder-area varies between *one-fiftieth* and *one-sixtieth* of the area of the middle-line plane; whereas in the ironclads fitted with balanced rudders it rises to *one-thirtieth*, and in some recent types in the French Navy and in the Russian circular ironclads has been made *one-twentieth*. *One-fortieth* would probably be a fair average for steamships of war. In merchant ships much smaller rudders are used, and values as low as *one-hundredth* have been met with.

None of these rules can be regarded as entirely satisfactory; because they take no cognisance of the law of variation of the resistance to rotation. When the angular velocity has become constant, that resistance varies nearly as the square of the angular velocity; and the moment of the pressure on the rudder should be proportioned thereto. In fact, it appears on investigation that the pressure on the rudder, which—other things being equal—depends upon the rudder-area, should in similar ships vary, not with the area of the middle-line plane, but with the product of that area into the square of the length, if the speed of turning is to be equal, after the motion has become uniform. In this statement it is assumed, of course, that the ships compared are of similar form; the limitations, explained on p. 507, for lateral resistance in sailing ships, being similar to those which will hold here. If regard is had to the initial motions of the ships under the action of their rudders, the moments of the pressure on the rudder should be made proportional to the moments of inertia of the ships. In other words, the products of the rudder-areas into the lengths of similar ships should be proportional to the moments of inertia, which will involve the product of the displacements into the squares of the lengths. The displacements will vary as the cubes of the lengths; the moments of inertia will therefore vary as the fifth powers; the area of the middle-line plane will vary as the square; and therefore, under this mode of viewing the question, the rudder-areas should be proportional to the products of the areas of the middle-line planes into the squares of the lengths. Expressed algebraically, if A_1 and A_2 are the areas of the middle-line planes of two similar ships; a_1 and a_2 the rudder areas; l_1 and l_2 the lengths: the rule would be—

$$\frac{a_1}{a_2} = \frac{A_1(l_1)^2}{A_2(l_2)^2}$$

This would give a much larger area to the rudders of long ships than is commonly adopted; and, as a matter of fact, long ships usually turn more slowly than short ships, in consequence of their proportionately small rudders.

Great differences of opinion have been expressed respecting the

best *form* for rudders. In Fig. 176 a few of the commoner forms are illustrated. The balanced rudder *a* has been previously described; *b* is a form much in vogue for the older classes of sailing ships and unarmoured screw-ships of the Royal Navy, the broader part being near the heel of the rudder, and the narrower part near the water-line; *c* is a form now commonly used in the steamships of the Royal Navy; *d* is the opposite extreme to *b*, the broadest part of the rudder being placed near the water-line: this form is much favoured in the mercantile

FIG. 176.

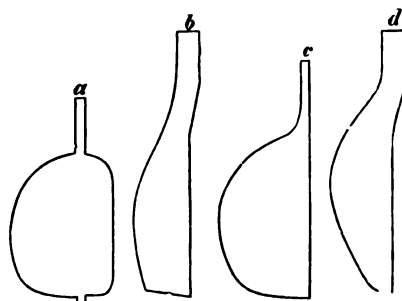

marine, especially for sailing ships, and is recommended on the ground that the lower part of a rudder is less useful than the upper part; but this is a misconception of the real facts of the case. From the remarks made on p. 454 as to the unequal motion of the currents in the wake of a ship, it appears that the fineness of the run near the keel should make the lower part of the rudder the most effective; and this has been verified experimentally.* Hence it seems probable that, with the form of rudder *d*, the narrower, lower part does quite as much work in steering as the broader, upper part: whereas, by tapering the rudder, the power required to put the helm over is made considerably less than it would be if the breadth were uniform.' These considerations would not have equal force in screw steamers where the rudder is placed abaft the screws; and then the form *c* is to be preferred, as the broadest part of the rudder is much less likely to be emerged by pitching than with the form *d*. In war-ships having under-water protective decks at the extremities, the rudder-head and steering gear are placed under those decks, six or seven feet below water. It then becomes necessary to use very broad rudders in order to gain sufficient area, and this form is advantageous also, because it enables the rudder to sweep out into the race of the twin-screws. With steam steering gear these broad rudders can be easily manipulated. In some vessels, to obtain greater command over their movements, the keel has been deepened aft, and the rudder thus made to extend below the body

* See the account of an experiment made by Mr. Froude, cited by Dr. Woolley, in a paper "On Steering Ships," read at the British Association in 1875. A model was fitted with a rudder of uniform breadth, divided into

two equal parts at the middle of the depth, and the lower half, when fixed at 10 degrees only, balanced the upper half fixed at 20 degrees when the model was towed ahead.

of the ship into less disturbed water. The case of Chinese junks also bears out the advantages obtained by placing rudders in water which has a maximum sternward velocity relatively to a ship. In the floating batteries built during the Russian war, "drop-pieces" were fitted at the bottom of the rudder, and hinged to the heel, so that, when the rudder was put over, they might drop down below the keel and increase the steerage. The results in this case were not entirely satisfactory, but the circumstances of these vessels were peculiar. To assist the steerage of large steamers when passing at low speed through the shallow waters of the Suez Canal, temporary enlargements are sometimes fitted to the permanent rudders, with beneficial results.

A few special forms of rudders may be mentioned. One proposed by Professor Rankine for screw-steamers was to be on the balanced principle, but to have curved sides, in order that the propeller-race in passing might communicate a pressure which should have a forward component and help the ship ahead to a small extent.

Herr Schlick proposed a very similar rudder, the surface of which was twisted, so that the currents driven obliquely from the screw-propeller, might move freely past the rudder when it was amidships, and not impinge upon its surface as they do upon that of an ordinary rudder. By this change it was supposed that two advantages would be gained: (1) there would be little or no check to the headway of a ship when the helm was amidships; (2) steering power would be obtained from all parts of the rudder surface immediately the helm was put over to either side, whereas with plane-surfaced rudders, placed behind screw-propellers, this is not the case. Experiments made at Fiume with small vessels are said to have demonstrated the great superiority of the new rudder in both these particulars. The following particulars have been furnished to the author by Herr Schlick. The *Vinodol* was 140 feet long, 19 feet broad, and $8\frac{1}{2}$ feet mean draught. She was first fitted with an ordinary rudder of 26 square feet area (immersed). With 89 to 90 revolutions of the screw per minute she traversed a distance of $2\frac{1}{2}$ knots in $14\frac{2}{3}$ minutes, and turned a circle of about 1000 feet diameter in $4\frac{3}{4}$ minutes. Subsequently a twisted rudder, having an immersed area of $17\frac{1}{2}$ square feet, was fitted. With the same steam-pressure and cut-off as before, 91 revolutions were made per minute, and the measured distance was run in 14 minutes 6 seconds, showing a gain in speed of about 4 per cent.; the circle turned had a diameter of 900 feet and was completed in 4 minutes 55 seconds. The vibration at the stern was also reduced.

Another novel and ingenious rudder has been patented by Mr. Gumpel. It is a balanced rudder as to suspension, but is carried on

crank-arms; and the fore edge has attached to it a vertical pintle, which works freely in a fore-and-aft slot cut in the counter of the ship. When the helm is put over, therefore, the fore edge of the rudder is constrained to remain at the middle line, the rudder being moved bodily over to one side of the keel by means of its crank-arms. This movement would be especially useful in the case of a twin-screw ship, since it would bring the rudder more into the race. The force required at the tiller-end to hold the rudder at any angle is less than that for an ordinary rudder; and the crank-arms can be so proportioned that, when the rudder is hard over, little or no force is required at the tiller to hold it there. Mr. Gumpel tried the rudder in a small steam yacht with great success; but it has not been tested on a large scale. There are obviously greater risks of damage and derangement with this rudder than with balanced rudders fitted in the usual manner.

Mr. Lumley proposed to make ordinary rudders in two parts, hinging the after part to the fore part, which was attached in the usual way to the stern-post. When the helm was put over to any angle, it moved the fore part of the rudder through an equal angle; but the after part was made to move over to a greater angle by means of a simple arrangement of chains or rods, and thus a greater pressure on the rudder was obtained. Several ships were fitted on this plan, and it was favourably reported upon in some cases, but has now fallen into disuse, at least in the Royal Navy.

Auxiliary Appliances for Steering.—Of the auxiliary appliances fitted to increase the steering power of ships, the most important are *bow rudders*. These rudders are rarely fitted except in vessels which are required to steam with either end foremost; to avoid the necessity for turning, or to be capable of service in rivers or narrow waters where there is little room for turning, or to meet some other special requirement. In nearly all cases arrangements are made by which such rudders can be locked fast in their amidship position when the ship is steaming ahead. Few ships of the Royal Navy are thus fitted. The jet-propelled *Waterwitch*, intended to steam indifferently with either end foremost, had rudders at both ends. Many coast-defence and river-service gunboats have rudders hinged to their upright stems for use when steaming astern in narrow waters. The cable ship *Faraday* had a bow rudder for use when steaming astern; when steaming ahead it was locked fast amidships, and similar arrangements are not uncommon in double-bowed river or ferry steamers which do not turn when reversing their course. Ordinarily, bow-rudders have been hinged at their after edge either to the stem or to an axis situated a

little abaft the stem, a recess being formed to shelter the rudder when locked amidships. Several obvious objections arise to this mode of fitting, especially in war-ships, and for use when steaming ahead. Rudders so placed are very liable to damage or derangement from collision or blows of the sea. If put over to a good angle they must cause a considerable increase of resistance and disturbance of the flow of water relatively to the ship. Moreover, if hinged at their after edges to the body of a ship, these bow-rudders have a further disadvantage, if used when going ahead, because the accumulation of pressure which then takes place on the fine part of the bow, on the side to which the rudder is put over, acts against the rudder-pressure and diminishes its turning effect.* This additional pressure resembles that described on p. 670 as acting on the deadwood or stern-post before an ordinary stern-rudder when a ship is going ahead; only in that case it increases the turning effect of the rudder. Hence it appears that, if bow-rudders have to be used as auxiliaries to stern-rudders when a ship is moving ahead, they should be so placed that the streams flowing past them should not subsequently impinge directly upon the hull and reduce the speed of turning. This can be done either by using balanced rudders, placed in large recesses in the bow, or by fitting the rudders so that they can be dropped into clear water under the bow, somewhat as has been mentioned for the drop-rudders of Chinese junks.

The latter plan has been used in many torpedo-boats, in association with rudders at the stern. They were found useful in diminishing both the time and space required for turning when the boats were going ahead, and in keeping the boats under control when going astern, and when the stern rudders on the ordinary plan were ineffective. In some of the smaller boats the heeling effect of these bow-rudders under the bow was found objectionable, especially if the helm was put down quickly, and as other means have been found for increasing the manœuvring power when going both ahead and astern, bow rudders have ceased to be employed.

In the *Polyphemus* torpedo-ram of the Royal Navy a balanced two-bladed bow-rudder was fitted, and arranged so that it could be drawn up into recesses when desired, or dropped under the keel when in use. Careful observations were made on the turning powers of the vessel at various speeds, with the ordinary stern rudder only, as well as with both stern and bow rudders working together. It was found that when the ship was moving ahead at various speeds, the use of the bow-rudder reduced the "tactical diameter" and the time of reversing the course (completing the first half-circle) by about twelve

* This effect may often be observed in the slow motion of a Thames passenger-steamer when turning astern with the helm hard over to swing clear of a pier.

per cent. Going astern at 11 knots, with the stern rudder only at work, the vessel was not well under control, and under many circumstances of wind and sea did not obey her helm. With the bow rudder also at work she was perfectly under control, and turned astern in a circle of which the diameter was little greater than that for an equal speed ahead.

One serious objection to bow rudders is that their action depends entirely on the relative movements of the ship and the water; and that the action of the propeller-race does not give steerage, as it does with a rudder near the propeller, before the ship gathers way. This is not true with the arrangements illustrated in Figs. 167-169, and their successful application has practically caused the disuse of bow-rudders. Vessels fitted with these plans have proved very handy, both when moving ahead and going astern.

A very interesting series of trials has been made by the Admiralty on three torpedo-gunboats. One of these (*Rattlesnake* class) had a straight keel and an ordinary rudder; a second was identical with the first, except that the after deadwood had been cut away, and the "turn-about" system applied (Fig. 168); a third and larger vessel (*Sharpshooter* class) was fitted with the rudder illustrated by Fig. 167, and had her deadwood cut away to a smaller extent. It was found that the first vessel behaved similarly to torpedo-boats built with straight keels and ordinary rudders, as was anticipated from the great ratio of length to draught. With 33 degrees of helm the tactical diameter was about $7\frac{1}{2}$ times the length, and over 4 minutes was occupied in turning the circle at full speed. In the sister ship, fitted on the "turn-about" system, the tactical diameter for the same helm-angle was about 5 times the length, and the time for the circle was under 3 minutes. These greatly superior results were due to two causes: the large increase in rudder-area, and the removal of the deadwood. Going astern, the first vessel was not under control of her rudder; the second was perfectly under control, and the tactical diameter was about $9\frac{1}{2}$ times the length, while the time for the circle was from $7\frac{1}{2}$ to $8\frac{1}{2}$ minutes.

The vessel of the *Sharpshooter* class fitted with the rudder illustrated in Fig. 167 was *one-sixth* longer and nearly 2 knots faster than the others, while her draught of water was rather less. Her maximum helm-angle was 35 degrees. At full speed ahead the tactical diameter was about $6\frac{1}{2}$ lengths, and the time for the circle $3\frac{1}{2}$ minutes. Going astern, the tactical diameter was about $8\frac{3}{4}$ lengths, and the time for turning the circle 8 minutes 50 seconds. These results indicated great manœuvring power, although not so great as those obtained with the "turn-about" system, and the latter plan has been generally used in the later torpedo-gunboats.

Steering screws have also been suggested as a means of considerably increasing the speed of turning, or of enabling a single-screw steamship to turn without headway. The principle of most of these proposals is to fit a screw of moderate size in the deadwood either forward or aft, in such a manner that, when set in motion by suitable mechanism, its thrust shall be delivered at right angles to the keel-line. Small manœuvring screws, driven by manual power, had been previously proposed and tried in sailing ships; but Sir N. Barnaby, we believe, first suggested the use of similar and larger screws, driven by steam-power, for the *Warrior* and *Minotaur* classes of the Royal Navy: proposing to fit the steering screws at the bows of these ships, in apertures cut in the deadwood for the purpose.* Subsequently the late Astronomer Royal, Sir George Airy, proposed a similar screw, but suggested that it should be placed in the after deadwood below the main propeller-shaft. Other proposals of a similar character have also been made; but we are unaware of any trials having been made on actual ships. There can be no doubt as to the manœuvring power that might thus be obtained; but considerable practical difficulties would have to be overcome in carrying the plan into practice and communicating driving power to the steering screws.

The use of water-jets expelled athwartships from orifices near the bow and stern has also been repeatedly suggested; not merely for jet-propelled vessels, but for screw steamers. Trials were made of this principle on a gunboat belonging to the Royal Navy in 1863, but they were not so successful as to lead to an adoption of the plan. For a given amount of engine-power much better results might be hoped for from the employment of a steering screw, such as is described above, than from the use of water-jets.

A special form of steering screw proposed by Herr Lutschaunig deserves to be mentioned.† It consists of a small screw carried by the rudder, and put over by the helm to the same angle as the rudder. By means of a simple train of mechanism, the steering screw is made to revolve by the motion of the main propeller-shaft; and its thrust is always delivered at an angle with the keel when the rudder is put over. A very similar arrangement was subsequently patented, and fitted to several boats and small vessels by Mr. Kundstadter. Trials made with these vessels were said to have given satisfactory results both as regards speed and turning power. Prior to the actual trial of this principle, it was anticipated that considerable

* See the *Transactions* of the Institution of Naval Architects for 1863 and 1864.

† See the *Transactions* of the Institution of Naval Architects for 1874.

steering power might thus be obtained if the steering screw was suitably arranged for working in the race of the main propeller. It is clear, however, that the mechanism of the steering screw is of a character and occupies a position which renders it liable to derangement, while damage to it might interfere seriously with the efficiency of the main screw propeller. No extended use has been made of the plan.

The difficulties experienced in the steerage of high-speed torpedo-boats have given rise to various devices for increasing the manœuvring power. To some of these attention has been directed above. One of the most ingenious mechanical arrangements made for this purpose is the "steering paddle" patented by Mr. Thornycroft. It consists of a broad-bladed paddle placed near the stern of the boat, and operated by steam-power somewhat in the manner in which a "scull" over the stern is operated by hand. In the small boat to which it was fitted it answered perfectly, and enabled her to be "slewed" without headway. On a larger scale it would be practicable; but it would require a considerable engine-power in a ship of large size to produce results at all comparable with those obtained in the experimental boat.

A twin passenger-steamer, the *Alliance*, designed by Mr. George Mills, had manœuvring paddle-wheels fitted at the bow and stern, the axes of the wheels lying fore and aft, and their thrust being delivered athwartships. No reports of the performances of this vessel are recorded, but we are informed that the plan was adopted chiefly to enable the vessel to "cant off" from the piers on the Clyde.

Auxiliary rudders of various kinds have been tried, but none have proved so successful as to pass beyond the experimental stage, or to be used apart from the special circumstances for which they were devised. In some of the floating batteries built during the Crimean War, in which the shallow draught and peculiar form made steering very difficult, auxiliary rudders were fitted on each side at some distance before the stern, and arranged so that they could be put over to an angle of about 60 degrees. No sensible improvement in the steering appears to have resulted from these additions. Another form of auxiliary rudder was proposed by Mr. Mulley, and tried at Plymouth in 1863. It consisted of a rudder fitted on each side of the after deadwood, at a short distance before the screw aperture; it was hinged at the fore edge, and, when not in use, could be hauled up close against the side, but, when required, could be put over to 38 degrees from the keel-line. When applied to a paddle-wheel tug, it answered admirably, steering her by its sole action, and making her turn more rapidly when acting in conjunction with the main

rudder. It completely failed, however, when tried on a screw ship, and produced a distinct turning effect on the ship in the direction opposite to that in which it was expected to act. The explanation of the failure suggested by the inventor is probably correct: the action of the screw propeller may have produced a negative pressure on the side of the deadwood abaft the auxiliary rudder when it was put over; and the turning effect of the negative pressure more than counterbalanced the effect of the auxiliary rudder. Possibly, if the latter had been placed further before the screw, it might have succeeded, as it did in the paddle-wheel vessel.

Another kind of auxiliary rudder was tried in her Majesty's ship *Sultan*. She was fitted with sliding rudders, one on each side, arranged so as to counterbalance one another; when one was allowed to project under the counter, the other was drawn up into a casing within the ship, and both could be "housed" when desired. The area of each of these auxiliaries, when fully immersed, was about *one-sixth* of the area of the main balanced rudder, and it was set about 50 degrees from the keel-line. On trial it was found that the small area and the position of the auxiliary rudder rendered its steering effect practically unimportant.

Another plan of auxiliary rudders was tried in the corvettes of the *Comus* class of the Royal Navy. It was desired to give these unarmoured vessels the advantage of a submerged rudder in addition to the ordinary rudder, for use in case of damage to the latter in action. For this purpose a recess was formed in the deadwood under the shaft, and before the single screw propeller. The auxiliary rudder was placed in this recess, hinged at the fore end, and when housed amidships it nearly made good the recess in the deadwood, completing the shape of the ship. It could be put over to about 30 degrees, but as manual power only was available, the time occupied in putting the helm over was very long. On trial it appeared that, although the area of the auxiliary rudder approached equality to that of the ordinary rudder, it possessed little steering power. It was then decided to fit side-blades on the Joëssel principle as a further experiment, and when this was done the auxiliary rudder proved capable of turning the ship in about three times the period which sufficed for a complete circle with the ordinary rudder, the diameter of the circle being increased about four times. This result was not satisfactory, and, as it involved a sensible loss of speed, when the auxiliary rudder was locked amidships, it was finally decided to remove the side-blades, and to leave the single-bladed rudders as first fitted, simply as a reserve in case of damage. In subsequent vessels of the class similar rudders were not fitted. These experiments incidentally furnished remarkable evidence of the gain in

steering effect, for the case of headway, generally obtained by placing the rudder abaft the screw.*

Steering blades or boards somewhat similar in principle to those tried in the *Sultan* have been used successfully in vessels designed for shallow-water service. These blades were set at an angle of about 45 degrees from the keel-line on either side, and could be pushed out from the stern or dropped down into the water on the side towards which the head of the ship was to be turned. The idea is an old one, and has been made use of on some occasions to steer seagoing ships which have lost their main rudders.

Of the very numerous plans of "jury rudders" which have been proposed, we can say nothing in the space at our disposal. They are all based upon the principles explained above for the ordinary rudder, and are more or less satisfactory expedients for taking the place of the rudder properly belonging to any ship.

Steering by Propellers.—Various methods have been devised for steering steamships by means of their propellers, independently of the action of the rudder.

Single-screw ships, as ordinarily fitted, do not possess this power. As explained on p. 658, they can be slewed without headway by using the rudder and the screw. It is also a matter of common experience that, with the helm amidships and screw in motion a single-screw ship can be turned completely round in smooth water, and in a calm or light winds. In most cases turning under these circumstances is performed slowly and in circles of large diameter. In flat-bottomed ships with full sterns it may be otherwise. The commanding officer has little or no command over the direction in which the vessel turns, and in practice the action of the wind or sea may counterbalance or overcome the steering effect of the screw. Even in smooth water and calms the steering effect varies as certain conditions change. Many interesting facts bearing on this subject will be found in the Reports of the British Association Committee mentioned on p. 659.† The broad conclusions from experience may be summarized as follows:—

(a) When a ship is moving ahead at good speed with screws well immersed and helm amidships, then, with ordinary forms of

* M. Normand has discussed the relative efficiencies of rudders placed before and abaft the screws in two interesting papers, published in vols. 1 and 4 of the *Bulletin de l'Association Technique Maritime*. From experience with torpedo-boats, he considers that equal steering power may be obtained provided the rudder, if placed before

the screws, is sufficiently distant to permit the water deflected by the rudder to resume its normal direction of flow before reaching the propellers.

† See also a paper by Professor Osborne Reynolds in the *Transactions* of the Institution of Naval Architects for 1873; and one by Mr. Maginnis in the *Transactions* for 1879.

stern, the water in the upper portion of the wake has a greater forward motion than that in the lower portion. Consequently the thrust on the upper blades of the screw is greater than that on the lower blades, and the excess in the transverse components of the thrusts produces a steering effect. The bow of the ship tends to turn towards the side on which the screw descends. If the screw be right-handed, the head will tend to turn to starboard; if it be left-handed, the head will tend to turn to port. If the helm is left free, the rudder will rest in a position inclined to the keel-line on that side towards which the particles of water in the race are driven by the lower blades of the propeller.

(b) If the screw is not well immersed, if the ship is just starting from rest, if she is moving very slowly ahead, or if the engines are suddenly reversed when the ship is moving at good speed ahead, then the thrust of the lower blades may be in excess of that on the upper blades, and the steering effect will be the opposite of that described in the first case.

(c) When the vessel has sternway, the lower blades are likely to have a greater thrust than the upper, and the steering effect will be similar to that described for the first case.

These rules necessarily have many exceptions in practice, as the circumstances may vary in a great many ways. No general rules can be laid down, but commanding officers soon become familiar with the general tendency in individual ships.

A single-screw ship can be turned more quickly in one direction than in the other, because of this steering effect of the screw. In some cases the difference in times of turning is greater than in others. For example, the *Bellerophon* completed a circle turning to starboard in 4 minutes, but required 4 minutes 20 seconds to complete a circle of the same diameter turning to port. The floating battery *Terror* was built with a very full stern, causing a great excess of thrust on the upper blades of the propellers. The circle with starboard helm occupied 5 minutes 12 seconds, and that with port helm 6 minutes 18 seconds. With the helm left free she turned to port and completed a circle in 5 minutes 52 seconds, or less time than she turned to starboard (with port helm) under the action of her rudder hard over. On consideration it will be seen that, when the rudder is used in a ship with her screw well immersed, the streams delivered by the lower blades impinge more directly upon the lower part of the rudder when it is put over to the side on which the blades descend when the ship is going ahead, than they do when the rudder is put over to the other side. This circumstance further assists the steering to one side as compared with the other. Pilots always allow for the steering effect of the screw in entering rivers, harbours, or docks.

Various proposals have been made for the purpose of gaining steering power from the direct thrust of single screws. One of the earliest plans was that proposed by Mr. Curtis, in which the screw was attached to the shaft by means of a suitable joint, and was carried by a frame hinged like a rudder to the stern. The frame, carrying the propeller, could be put over with the helm to any angle desired; and the thrust of the screw, driven by the main engines, was then delivered at an angle with the keel-line, exercising a powerful turning effect on the ship. On trial it was found that this turning effect was very powerful, and the motions of the small vessel so fitted were very rapid; but there was far less control over the motion than with the rudder, and this fact, together with the difficulties and risk of derangement to the propelling apparatus which would attend the adoption of the plan on a large scale, has prevented its use.

An ingenious plan for effecting the same object has been patented by an American, Colonel Mallory, who devised a method for rotating the screw through a complete circle, and meanwhile keeping the main engines running continuously in one direction. A boat fitted with the Mallory propeller can be turned almost on her centre, stopped very rapidly, and kept thoroughly under control by the action of the screw alone, no rudder being fitted. The American torpedo vessel *Alarm* (of 140 feet length and 750 tons displacement) was fitted with this propeller, and the Report of the Board of Naval Engineers who conducted the trials was very favourable. It was asserted that, without any loss in efficiency as a propeller when compared with single or twin-screws, there was an enormous gain in manœuvring power. The only drawbacks were considered to be "increased cost and complexity of mechanism and necessarily decreased reliability and durability;" but for torpedo-boats, small rams and gunboats, the Board considered the advantages of the Mallory system to far outweigh its disadvantages. Notwithstanding this favourable report, the system has not found favour or been widely used.

Another very ingenious method of increasing manœuvring power in single-screw ships has been fitted by Mr. Thornycroft to a large torpedo-boat, in connection with the novel form of propeller described on p. 582. The "guide-blades" behind the screw are enclosed by a casing, and abaft this casing is another casing carried by the rudder. When the helm is put over, the water from the screw is therefore delivered into the after casing, which is set obliquely to the keel-line, and the manœuvring power thus obtained when the boat is moving ahead has proved to be most remarkable on trial; the boat which previously traversed a large circle in turning could be slewed almost without headway, the bow remaining nearly at rest. For sternway the plan is not well adapted.

A manœuvring propeller was invented some years ago by Mr. Moody, and applied to a few barges on the Clyde. It was subsequently proposed by Mr. Fowler, who does not appear to have been aware of the other invention, and fitted to the American torpedo-vessel *Alarm*, as well as to a few small vessels. This propeller consists of a feathering paddle-wheel placed at the stern, the axis of the wheel being vertical. By means of a suitable mechanism the paddle-floats can be made to "feather" at any point in their revolution; and in this way the maximum thrust can be delivered in different directions, and made either to propel the vessel ahead or astern, or to steer her on any desired course. The apparatus was said to have answered well in the *Alarm*, as regards handiness, but not to have been favourable to speed. It was removed, and a Mallory propeller substituted, with a considerable gain in speed and greater handiness. Another American invention of a very similar kind consisted of two feathering wheels placed on opposite sides of the stern-post and made to revolve in opposite directions when the ship is turning. All such devices are obviously more liable to derangement, damage, and fouling than screws, nor can they be so efficient as propellers.

Vessels fitted with duplicate propellers, such as disconnecting paddle-wheels, water-jets, or twin-screws, can be manœuvred more or less successfully by the propellers alone. By making one propeller deliver its thrust ahead and the other astern, a ship can be made to turn nearly on her centre without headway; if only one propeller is used, she will describe a circle of more or less considerable diameter; and if the rudder is used in association with either of these conditions it is possible to increase the speed of turning or lessen the space traversed. The principle is the same for all three propellers, but the distance between the lines of thrust of twin-screws is commonly less than *one-half* the extreme breadth of a ship, whereas, with disconnecting paddles, the corresponding distance would commonly be *four-thirds* the extreme breadth; and with water-jets the distance somewhat exceeds the breadth. Notwithstanding this advantage, twin-screws compared favourably with water-jets on the only occasion on which we know their turning powers to have been tried in competition. No similar competitive trials appear to have been made with twin-screws and disconnecting paddles; but the restricted use of paddle-wheels makes it unnecessary to inquire into their relative merits.

Nearly all twin-screw vessels are fitted with single rudders at the after end, as shown in Figs. 163–165, and such rudders, as already explained, are not so directly under the influence of the propeller-race as are the corresponding rudders in single-screw ships. Consequently, it is desirable to make the rudders of twin-screw ships of great breadth, in order that they may sweep out into the race

of one or other of the screws. On this account ordinary rudders have been very commonly adopted with twin-screws, and for a time there was a general disinclination to use balanced rudders in these vessels. Possibly this opinion was partly based upon the unsatisfactory manœuvring of some twin-screw vessels, built primarily for coast defence, in which the under-water form was very full, and the want of control was due to that fact fully as much as to the balanced rudders. Even at that period there were facts pointing in the direction of the efficiency of balanced rudders in twin-screw ships of good form. The *Iron Duke*, for instance, with twin-screws and an ordinary rudder, occupied about 4 minutes 38 seconds in turning a circle 505 yards in diameter; whereas sister ships fitted with balanced rudders occupied only 4½ minutes in turning circles of 325 to 400 yards diameter. It must be admitted that during the first movements of the propellers ahead or astern in a twin-screw ship, the rudder has not as great steerage power as in a single-screw ship. On the other hand, in the twin-screw ship there is the enormous advantage that the screws can be worked in opposite directions and the ship turned on her centre. Extended experience has also placed it beyond question that under all the ordinary circumstances of navigation twin-screw ships fitted with either ordinary or balanced rudders can be made practically as handy and manageable as single-screw ships. Recent types of swift cruisers with fine under-water forms, twin-screws, and balanced rudders have been proved to possess manœuvring powers of the most remarkable character. Where difficulties have occurred in the steerage of twin-screw ships, they have usually been traceable to singularities of form under water or at the stern, to ill-considered arrangements of rudders, or to improper relative positions of propellers and rudders. It will not be overlooked that, from the necessities of the case, twin-screws are commonly fitted in vessels of shallow draught and full form; and there is a danger of attributing to twin-screws features of performance which would be the same if single screws had been fitted. The remarks made above as to the floating batteries built during the Crimean War bear this out.

One remarkable case deserves brief notice. In the twin-screw armoured ships *Ajax* and *Agamemnon*, of full form and shallow draught, considerable difficulties were experienced in steering. The movements of the vessels were erratic and uncertain under the action of the helms. It was recognized that their flat floors and blunt ends made them "unsteady" on a course. But this did not explain their behaviour entirely. Careful observations and experiments with models showed that the peculiar form of the stern in the neighbourhood of the water-line was the chief cause of trouble. Behind this

blunt termination a mass of dead-water accumulated and practically travelled for a time with the vessel. At intervals this mass of dead-water fell off the stern, sometimes on one side and sometimes on the opposite side, thus causing unbalanced reactions on one or other side at the stern, and making the vessel "yaw." By a simple alteration in the shape of the stern, which gave it a fine termination, the accumulation of dead-water was prevented, and the consequent disturbance avoided. Subsequent experience proved that the control of the ships had been very greatly improved, and their manœuvring is now as good as can be obtained with vessels so full and flat in form.

Speaking broadly, extended experience with twin-screw vessels has established the following conclusions:—

1. That with both screws working ahead at all speeds used in practice, except dead-slow, twin-screw ships are as well under control with the helm as single-screw ships, turning as quickly and in as small space for the same dimensions and speeds.

2. That with helm amidships, one screw working ahead and the other astern at properly adjusted rates, such vessels can be turned nearly upon their own centres, but the time of turning is considerably greater than when both screws are working ahead and the rudder is used. It will be remarked that, when the screws are thus worked, that which is turning ahead delivers its race aft, and tends to diminish the pressure on that side of the deadwood to which it is adjacent; whereas that which is turning astern delivers its race forward and tends to increase the pressure on its side of the deadwood. The head of the ship turns towards that side where the screw is working astern, and consequently the excess of pressure on the same side of the deadwood aft helps the thrusts of the propellers in turning the ship. This fact tells sensibly in favour of the manœuvring power of twin-screws. Another circumstance worth noting is the difference which exists between the effective thrusts of the two screws; that which is working ahead has the greater thrust, and the excess in thrust constitutes a force tending to propel the vessel ahead, increasing the space she requires in turning. If the ship is of fine form and easily moved at moderate speeds, she may therefore traverse a considerable space in turning under the assumed conditions; if she is of large size and full form, the difference in the thrusts may only suffice to give her a small speed when she will occupy little space. To illustrate this statement we may take the cases of her Majesty's ships *Iris* and the ill-fated *Captain*, which have nearly equal lengths. With one screw ahead and one astern, the *Iris* traversed a circle of about 500 yards diameter, say 5 times her length; whereas the *Captain* traversed a

circle of 150 yards mean diameter, or about $1\frac{1}{2}$ times her length. By suitably adjusting the revolutions of the engines, a twin-screw ship may, of course, be turned upon her centre.

3. That when the screws are working in opposite directions, as in the preceding case, if the helm is put over, the time of turning is usually greater than when both screws are working ahead and the rudder is used. For example, the *Captain* took 5 minutes 24 seconds to complete a circle of 750 yards diameter with both screws full speed ahead and helm hard over; as against 6 minutes 52 seconds in the other condition, when she turned nearly on her centre. The explanation of the difference is to be found in the diminished efficiency of the rudder produced by the absence of headway, as well as by the action of the screw which is working full speed astern on the side towards which the rudder is put over. It is worthy of remark, however, that the rudder does some work under these circumstances; for the time of turning has been found to be less than when the same vessel was turned by the action of the screws alone. In one instance the times for the two conditions were respectively 4 minutes 15 seconds and 6 minutes 55 seconds. A possible explanation of this circumstance may be found in the turning effect of the accumulated pressure that will act on the side of the deadwood before the rudder, and will assist the screws in turning the ship.

4. That when one screw is stopped and the other worked full speed ahead, with the rudder hard over, vessels can be turned somewhat more slowly than when both screws are working ahead. As to the relative diameters of the circles described under these two conditions, there is less agreement. In one case a twin-screw ship completed the circle in 3 minutes 48 seconds with both screws working ahead; and in 3 minutes 58 seconds with one screw stopped; the diameter of the circle in the latter case being one-third less than in the former. In the *Captain*, the corresponding results were 5 minutes 24 seconds to complete a circle 750 yards in diameter, when both screws were worked ahead, and 7 minutes 50 seconds to complete a circle 874 yards in diameter, when one screw was stopped. In the *Iris* the corresponding results were 8 minutes 14 seconds to complete a circle of 767 yards diameter at a speed of 10 knots with both screws, and 10 minutes to complete a circle of 613 yards diameter with one screw stopped.

5. That with one screw only at work and the helm amidships, the ship can be turned completely round; but the time of turning is considerable, and the diameter of the circle large as compared with the other modes of turning. In the *Captain*, about $9\frac{1}{2}$ minutes were occupied in turning a circle nearly 1100 yards in diameter.

Even this turning power might be of service, however, to a vessel of which the rudder and one screw had been damaged.

6. That with one screw at work ahead, the other being stopped, or allowed to revolve freely, the ship can be kept on a straight course by the use of the helm. The angle of helm required varies in different ships, and possibly at different speeds in a given ship. In the *Iris* at speeds of 7 to 8 knots, about 8 degrees to 10 degrees of helm sufficed. In the *Nelson* at 10 knots, 16 degrees of helm were required. Other cases have come under notice where the helm hard over did not keep a ship straight; but the fact simply proved that either the maximum helm-angle available was too small, or that a form and area of rudder had been adopted which were not suited to the ships. For effectiveness under these conditions the rudder should clearly be made broad, in order to sweep out into the race of the screw at work.

It is usual in twin-screw ships to place the shafts parallel to one another and to the keel; but more than once it has been suggested that advantage in steering might result from making shafts diverge from one another, in order to increase the leverage of the thrust of either propeller about the centre of gravity. This plan has been applied in the *Faraday*, a ship built for the special purpose of laying submarine telegraph cables, and therefore requiring great handiness under all conditions of wind and sea. It is said to have proved very successful; and with the rudder locked amidships, some of the most delicate operations connected with laying and splicing cables were performed in a rough sea and strong wind, the ship being manœuvred by the screws alone. The shafts in this vessel diverge from parallelism with the keel-line by being at a greater distance from it at their fore ends than at the after ends; abreast of the centre of gravity the distance between the shaft lines is about 40 feet, near the propellers the distance is about half as great. Another interesting fact in the management of this exceptional vessel is that, in order to maintain her position with wind or sea on the beam, the two propellers were frequently worked at different speeds and sometimes in opposite directions. She furnished, in fact, one of the most remarkable illustrations of the manœuvring power obtainable by the use of twin-screws.

Vessels propelled by three screws, one on each side and one at the middle line, will obviously possess the advantages in manœuvring both of single and twin-screw ships. The middle-line screw will deliver its race upon the rudder, just as happens in a single-screw ship, and so give steerage with little or no headway or sternway. The side screws are capable of being manœuvred like those of a twin-screw ship. It is probable that these considerations

have had some influence on the decision to construct triple-screw vessels; although the governing condition has been the desire to secure economical propulsion at low cruising speeds.

Jet-propelled vessels, when moving ahead at full speed, derive their steering power from the reaction of the water in the wake upon the rudder; and, as previously explained, this is likely to be less than that on a rudder placed in the race of a screw. In the trials made with the twin-screw ship *Viper* and the jet-propelled *Waterwitch*, there was practical identity of length and draught, as well as approximate equality of displacement and speed; but the *Viper* was constructed with two deadwoods, and had a rudder on each, while the *Waterwitch* had only one rudder at work, the rudder at the fore end being locked. Hence any exact comparison between the manœuvring powers of the two systems of propulsion can scarcely be made from the trials of these ships; but the following facts may be interesting. When steaming full speed ahead, the *Viper* turned a circle in 3 minutes 17 seconds, as compared with 4 minutes 10 seconds for the *Waterwitch*; a saving of time in the twin-screw ship of about 20 per cent. With one screw reversed, the other full speed ahead, and the rudders hard over, the *Viper* turned on her centre in rather less time than with both screws working full speed ahead (3 minutes 6½ seconds, mean of trials in opposite directions).* The *Waterwitch*, under similar conditions, with one nozzle reversed, also turned on her centre, but occupied more than twice the time of the *Viper* (6½ minutes), and half as long again as she took when steaming full speed ahead. Making allowance for the additional rudder of the *Viper*, and the additional resistance to turning which her peculiar form of stern involved, it appears that the twin-screws possess some advantages over the jets in manœuvring; but further trials would be required to settle this point conclusively. It is, however, certain that ample manœuvring power can be secured with twin-screws in association with greater propelling efficiency than has yet been obtained, or is likely to be secured with water-jets.

In conclusion, it may be remarked that, throughout the preceding discussion, it has been assumed that the manœuvres of ships are performed in smooth water, in order that the principles of the action of the rudder, or of auxiliary appliances for steering, might be more

* It will be observed that this is an exception to the deduction marked No. 3 on p. 711; but the explanation of the difference is simple. As the *Viper* has two rudders, that placed behind the screw, which was driving the ship ahead,

always remained thoroughly efficient in assisting to turn the ship, although the other rudder, placed behind the screw, which was driving the ship astern, was less efficient.

simply explained. When ships are manœuvred in rivers, currents, or a seaway, or in stormy weather with high winds, their performances necessarily differ from those in still water; but all the varying conditions of practice can scarcely be brought within the scope of exact investigation; and the foregoing statement of principles will probably enable the conditions of any selected case to be intelligently treated.

INDEX.

ADMIRALTY :—

- Coefficients for steamship performance, 625
- Regulations for preservation of iron and steel ships, 427
- Agincourt*, grounding of, 35
- Air blast, 560
- Air resistance to motion of ships, 487
- Aluminium for bottoms, 435
- American :—
 - River steamers, special construction of, 334, 377
 - Wood-built ships, rapid decay of, 420
- Angle of leeway, 506
- Angular velocity of ships :—
 - When rolling, 149, 174
 - When turning, 670
- Arc of oscillation, 147
- Ardency of sailing ships, 509
- Armour :—
 - Contribution of, to structural strength of ships, 362
- Atwood's formula for statical stability, 127
- Augment of resistance due to screw propeller, 546
- Augmented surface, 452
- Automatic instruments for measuring and recording rolling, 290, 292
- Auxiliary appliances for steering, 699
- Awning deck vessels, 15
- Axis of rotation of a ship :—
 - When rolling, 151
 - When turning, 675
- BALANCED rudders : their advantages and disadvantages, 668
- Barques :—
 - Plain sail of, 513

Barques (*continued*) :—

- Position of centre of effort of sail, 522
- Stations of masts and base of sail, 523
- Batten instruments for observing rolling and pitching, 287, 288
- Beam of ships :—
 - Effect upon metacentric stability, 88
 - „ range of stability, 129
 - „ the resistance and propulsion, 464, 477
 - Ratio to length in sailing ships, 530
 - „ „ in unarmoured warships, 474
 - Ratio to length in ironclads, 475
- Beams :—
 - Approximate rules for strength, 406
 - Calculations of bending moments due to loads on, 301
 - Knees of, 391
 - Methods of scarphing wood, 408
 - Principles of strength, 351
 - Sectional forms in iron or steel, 405
 - To decks : as transverse strengtheners of ships, 324, 337, 389
- Bearers, longitudinal, contribute to local and general strength of ships, 334
- Behaviour of ships at sea. *See* Rolling and Pitching
- Bellerophon* in collision, 35
- Bending moments :—
 - Longitudinal, for ships, 299, 316, 317, 383
 - Methods of estimating, for beams, 301
 - Resistance of beams and girders, 351
 - „ ships to longitudinal, 357
 - „ „ transverse, 385
 - „ „ transverse for ships, 323, 326, 329

- Bilge-keels** :—
 Means of increasing fluid resistance to rolling, 177, 179
 Means of increasing steadiness in a seaway, 254
- Boilers** :—
 Forced draught, 560, 563
 Induced draught, 560
 Locomotive, 555, 562
 Types of, 554
 Water-tube, 556
- Bottom** (*see also* Double Bottom) :—
 Corrosion of iron and steel bottoms, 422
 Of wood ships, strong against grounding, 336
 Penetration of, 335
- Bow rudders**, 699
- Bows of ships** :—
 Construction of, for ramming, 339
 Influence of form upon pitching, 271
 Influence of form upon resistance, 463
- Bowsprits**, steeve of, 524
- Bracket frame** : system of construction for iron ships, 369, 372, 387
- Brass skins**, 435
- Brigs** :—
 Loss of older classes by swamping, 21
 Plain sail, and position of centre of effort, 513, 522
 Stations of masts and base of sail, 523
- Buckling**, special danger of, in iron or steel ships, 335, 347, 368, 402
- Builders' old measurement tonnage** :—
 Antiquity of rule, 47
 Examples of calculation, 49
 Objections to, and abolition of, 50
 Rationale of rule, 49
- Bulkheads, as watertight subdivisions** :—
 Arrangement of transverse, 23, 32
 " " longitudinal, 29, 32
 Means of maintaining stability, 110, 115
 Use of transverse, 334, 385
 " partial, 386
 " longitudinal, 356
- Bulkheads committee**, 41
- Buoyancy** :—
 Centre of, 80, 126
 Definition of, 2
 Loss of, causes ships to founder, 21
- Buoyancy** (*continued*) :—
 Reserve of, in different classes of ships, 9, 15,
 Strains due to unequal distribution of weight, 7, 299, 304
- Butt-joints** :—
 In wood ships, 349, 409
 In iron ships, 410
- CAMPANIA**, dimensions of, 419
- Captain**, her Majesty's ship (*late*) :—
 Curve of stability and principal dimensions, 132, 133
 Safety under sail in still water, 188
 Upsetting angle, amongst waves, 261
- Cargoes** :—
 Dangers of shifting, 110
 Stowage of, checked by rolling experiments, 171
- Causes of pressure on rudders**, 655
 " " foundering, 21
- Cellular construction for iron ships**, 32, 43, 369, 372, 387
- Cellulose packing**, 38
- Central-citadel ironclads** :—
 Forms and proportions of, 475
 Ram bows of, 339
- Centre boards of sailing vessels**, 507
- Centre of buoyancy** :—
 Approximate rules for position of, 87
 Defined, 80
 Motion of, as ship heels, 126
- Centre of effort of sails** :—
 Longitudinal position of, 522
 Method of estimating position, 521
 Vertical position of, 526, 528
- Centre of flotation**, 152
- Centre of gravity** :—
 Effect of vertical position of, upon range of stability, 133, 144
 Effect of position of, relatively to centre of effort of sails, 525
 Height of metacentre above, in various classes of ships, 90, 97, 100, 104
 Inclining experiments to determine vertical position of, 103
 Motion of, when weights are shifted, 103, 106
 Weight may be supposed concentrated at, in ships at rest, 80

- Centre of lateral resistance, 520
 „ pressure on rudder, 664
 Centrifugal pumps as a means of clearing water out of ships, 594
 Change of trim due to bilging, 27
 Estimates for, 119
 Cigar ships :—
 Conditions of stability for, 94
 Curve of stability, 127
 Still-water oscillations of, 155
 Circular ironclads, Russian :—
 Behaviour at sea, 248
 Rudder arrangements and steerage, 674
 Steaming capabilities of, 644
 Weights of hull for, 414, 645
 Clipper ships, proportions and performances, 530
 Coal consumption, rates of, for various types of engines, 564
 Rates of, for merchant ships, 566
 Coefficients of :—
 Augmentation (Rankine's), 452
 Fineness, for displacement, 3
 Friction (skin), 443
 Moment of inertia of plane of flotation, 87, 88
 Steamship performance, 542, 625
 Collision :—
 Construction of ram-bows to withstand, 339
 Examples of accidental, 35, 37
 Local strains produced by, 339
 Committee on bulkheads, 41
 „ „ load line, 13
 Comparative weights of wood, iron, and steel ships, 411
 Comparative durability of wood, iron, and steel ships, 419
 Compartments, watertight :—
 Methods of forming, 23, 29
 Of war-ships, 31, 33
 Composite ships :—
 Arrangements of decks, 366
 „ „ framing, 367
 „ „ skins, 375
 „ „ beam end connections, 340
 Freedom from fouling of the bottom, 432
 Compound engines :—
 Economy of fuel with, 564
 Weights of, 564
 Compressive strengths of wood and iron, 399, 400
 Conditions of equilibrium, 1, 80
 Copper sheathing :—
 Anti-fouling properties of, 428
 For iron ships, 432, 433
 Insulation of, in *Inconstant* class, 432
 Protected by zinc bands, 429
 Corinthian Yacht Club, rule for tonnage, 76
 Cork packing, 38
 Corrosion of iron ships :—
 Causes of, 422
 Experiments on rate of, 424
 Means of preventing, 427
 Cross curves of stability, 143
 Curves of :—
 Displacement, 5
 Extinction, for rolling in still water, 167, 184
 Flotation, 152
 Loads and bending moment, 304, 308, 311
 Metacentres and centres of buoyancy, 89, 93
 Progressive speed trials, 615, 631, 646
 Resistance for models and full-sized ships, 481
 Rolling motion of a ship under sail, 251, 264
 Stability, 129, 132, 135, 138, 142, 145
 Tons per inch of immersion, 6
 Turning for steamers, 679
 Wind pressure at oblique angles, 493
 Cutters :—
 Plain sail for, 513
 Position of centre of effort, 522
 Station of mast and base of sail, 523
 DANUBE rule for tonnage, 63
 Dead weight tonnage for merchant ships, 68, 70
 Deck erections, 17, 57
 Deck beams, planking, plating, and pillars, 380
 Decks :—
 Contributory to longitudinal strength, 354, 364

- Decks (*continued*):—
 Local strains on, 337
 Resistance of, to rolling and pitching with low freeboard, 184, 271
 Utilized as watertight partitions, 23, 27, 29, 32
- Deductions from turning trials of ships, 680, 687
- Delight* gunboat:—
 steering trials of, 692
- Design, general condition of, 642
- Detachable ballast, 39
- Determination of rudder areas, 693
- Devastation*:—
 Compared with circular ironclads, 645
 Inclination under wind pressure, 188
 Mr. Froude's rolling experiments with model, 177, 253
 Performances at sea, 239, 242, 257, 268
- Developments in dimensions and speeds, 418
- Diagonal riders:—
 For composite ships, 375
 For ordinary wood ships, 374
 Framing for iron ships, 377
 Not necessary for iron ships, 376
 Planking for wood and composite ships, 376
- Dimensions for screw-propellers, determination of, 611
- Dipping oscillations of ships, 164
- Disc area of screw-propellers, 599–617
- Dismasting of merchant sailing ships, 343
- Displacement:—
 Approximate rules for, 3
 Compared with B.O.M. tonnage, 49
 " " gross register tonnage, 70
 Curves of, 5
 Definition of, 1
 Most suitable tonnage for war-ships, 73
 Tonnage, 73
 " for yachts, 77
- Double bottoms:—
 Cellular construction of, 369, 372, 387
 Effect upon stability of water ballast in, 111, 117
 Facilitate preservation of skins, 427
 Uses of, in iron ships, 31
- Draught of water:—
 Changes in, by altered density of water, 7
 Changes in, by addition or removal of weight, 7
 Displacement for any, 5
 Effect upon, of entry of water into hold, 23, 30
 With changes of trim, 122
- Ductility, 400
- Durability of wood and iron ships compared, 419
- Dynamical stability (*see also* Stability), 158
- ECONOMICAL propulsion of steamships, 457, 464, 471, 648
 Cannot be exclusively considered, 637
 Favoured by increase in size, 637
 " certain types of machinery, 545, 580
 Favoured by suitable propellers, 614
 Narrowness not a necessity for, 648
 Not of paramount importance in all cases, 474, 477, 642
- Eddy-making resistance of ships, 453
- Effective horse-power, 537
- Efficiency of marine engines, 543
 " propellers, 584, 589, 601
 " steamships, 637
- Elastic limit, 398
- Elorn*, experiments in, 155, 177
- Engine design, influence of, upon ship design, 569
- Engines, marine:—
 Measures of power, 537
 Of swift steam-launches and torpedo-boats, 564, 649
 Types in common use, 552
 Weights per indicated horse-power and rate of coal consumption, 564
- Entrance of ships, connection between speed and length of, 459
- Equilibrium of ships:—
 Instantaneous position of, among waves, 229, 233
 Stable, unstable, and indifferent, 82
 When floating in still water, 1, 80, 82
- Equivalent girders for ships, 348, 355
- Experiments:—
 On air resistance, 487, 493, 498

Experiments (*continued*):—

- On deck resistance to rolling, 185
- On rate of corrosion of iron, 422, 424
- On resistance of ships, 453, 455, 466, 475, 479
- On resistance of wood and iron to penetration, 336
- On screw propulsion, 575, 580, 615
- On screws and paddle-wheels, 596, 603
- On screws and water-jets, 590
- On steerage of single-screw ships, 659
- On steerage of twin-screw ships, 661
- On steerage of jet-propelled ships, 657
- On still-water rolling, 157, 169
- On strengths of iron and steel, 400, 401
- On strengths of timber, 399
- On the effect of bilge-keels, 176, 255
- On waste of metals in sea-water, 424
- To determine vertical position of centre of gravity of ships, 102
- To determine "quiescent point" or *point tranquille* of ships, 155, 168
- With model screws, 616

FACTORS of safety for wood and iron, 403, 406

Fan-draught: open stoke-holds, 563

Fastenings in ships:—

- Importance of proper, 346
- Metal bolts in wood ships, 409

Fillings between frames of wood ships very useful, 365

Flanged forms of beams and girders very advantageous, 354, 405

Flush-deck vessels, 15

Forced draught, 559

Forces required on tillers, 663

Formulæ:—

- Admiralty, for steamship performance, 625
- Atwood's for statical stability, 127
- Centre of pressure on rudder, 664
- Expressing relative economy of steam power in large and small steamers, 638
- For augmented surface of a ship, 452
- For observing waves, 208
- Heeling force when steering, 685

Formulæ (*continued*):—

- Maximum angle of heel in unresisted rolling among waves, 238
- Moseley's, for dynamical stability, 160
- Normal pressure on a plane advancing obliquely in water, 440, 441
- Period of unresisted rolling in still water, 150
- Sail-carrying power, 528
- Trochoidal waves, 204
- Fouling of bottom:—
 - Effect on resistance of ships, 428
 - Especial disadvantages of iron ships, 430
 - Proposals for preventing, 431
- Foundering of ships, causes of, 21
- Framing of ships:—
 - Diagonal, for iron ships, 377
 - Longitudinal for iron ships, 368, 372
 - Subordinate to skins, 370
 - Transverse, in iron and composite ships, 364, 367
 - Transverse, in wood ships, 363, 386
- Freeboard:—
 - Effect of, upon the stability, 129
 - Various rules for, 10, 12
- Free water in a ship, effect on stability, 112
- Freight tonnage, 72
- French:—
 - Experiments on still-water oscillations, 155, 177
 - Observations of deep-sea waves, 215, 221, 224
 - Rule for nominal horse-power, 541
- Fresh water, weight of, 7
- Frictional and eddy-making resistance of ships, 450
- Frictional resistance:—
 - Constant, of engines, 544
 - Generally, 442
 - To motion of ships, 451, 466
 - To rolling of ships, 175, 250
- Froude, the late Mr. W., F.R.S.:—
 - Disadvantages of large screws, 608
 - Investigations on resistance to oscillation of ships, 166, 227, 233
 - Modern theory for rolling among waves, 227, 233
 - Report on behaviour of *Devastation*, 242

- Froude, the late Mr. W., F.R.S. (*continued*):—
- Experiments :—
- On usefulness of bilge-keels, 177, 255
 - On resistance of ships and models, 479, 483
 - On relative efficiencies of upper and lower parts of rudders, 697
 - On frictional resistance, 443
 - On wave-making resistance, 456, 462
 - On air resistance, 493
 - On ratio of effective to indicated horse-power, 543
 - On screw-propulsion, 599, 615
 - On circular ships, 645
 - On planes and rudders, 664
- GALVANIC** action :—
- Accelerates corrosion of iron skins, 423
 - Assists in preventing fouling of zinc sheathing, 435
 - Means of preventing, 425
 - Special danger in iron ships copper-sheathed, 433
- Girders** :—
- Equivalent for longitudinal strength of ships, 348, 357
 - Comparison of ribs and adjacent parts of skin to, 386
 - Lattice, used as strengtheners to shallow ships, 379
 - Principles of strength, 351
- Graphic integration, 251
- Great Britain* dimensions, 419
- Great Eastern* dimensions, 418
- „ „ ashore, 34
 - „ „ framing of, 334
- Great Western* dimensions, 419
- Greyhound*, H.M.S. :—
- Model experiments on resistance, 475, 480
 - Rolling experiments in still water, 175
 - Rolling experiments in a seaway, 255
 - Used as basis for calculations of performance under steam of large ships, 635
- Grounding, local strains produced by, 335
- Grosser Kurfurst*, loss of, 37
- Gunboats, unarmoured :—
- Engine-power and speeds, 649
- HEAD** resistance to motion of bodies through water, 438
- Headway, advantage of, to ships in turning, 656
- Heaving oscillations, 203, 260, 273
- Heeling produced by :—
- Action of wind on sails, 82, 187, 329, 498, 504, 527
 - Entry of water into hold, 29
 - Shifting weights athwartships, 103
- Heeling of ships in turning, 684
- Hercules* in collision, 35
- Helm** :—
- Angle of greatest efficiency, 692
 - Importance of quick motion, 690
 - Power to put it over, 663
 - Starboard and port, weather and lee, 655
- Hog frame in shallow-draught vessels, 309, 377, 379
- Hogging** :—
- Causes of, in still water, 300
 - „ on wave crest, 313
 - Conditions of strain incidental to, 317, 383
- Holyhead packets, steaming capabilities of, 574
- Horse-power of marine engines :—
- Effective, 537
 - Indicated, 537
 - Lloyd's rule, 541
 - Measures of, 536
 - Nominal, 539
 - Normal, 541
- Hulls of ships :—
- Advantages of iron as compared with wood, 411, 419
 - Recent use of steel, 415
 - Should combine lightness with strength, 3
- Hydromotor* propeller, experiments with, 592
- INCLINING** experiment, 103
- Indicated horse-power, 537

- Iron as a material for shipbuilding :—
 Compared with wood, 395, 399, 403
 Modulus of elasticity, 400
 Resistance to bending strain, 406
 „ „ perforation, 336
 Simple combinations possible with, 410
 Tensile and compressive strength of
 (*see also* Corrosion, Fouling, and Wood), 400
- Ironclads :—
 Behaviour at sea, 245, 257
 Expenditure of engine-power, 641, 642
 Local requirements in structures, 382
 Long and short types compared, 643
 Longitudinal strains of, 317, 383
 Rapid decay of wood-built, 420
 Rudder areas of, 696
 Sailing capabilities of, 518
 Speeds under steam, 641
 Structural arrangements of, 369
 Watertight subdivision of, 32
 Weights of hull for, 417
- Iron Duke* ramming *Vanguard*, 36
- Iron ships :—
 Beam end connections, 369, 390
 Causes of corrosion, 422
 Compared with steel ships, 415
 Construction of decks, 389
 „ „ ram-bows, 339
 Copper and zinc sheathing for, 432
 Features of superiority to wood ships, 32, 323, 326, 339, 349, 376, 410
 Fouling of bottoms, 428
 Great durability of, 421
 Methods of framing, ordinary and special, 364, 369, 372
 Penetrability of bottom, 336
 Progress in construction and sizes, 418
 Skins of, 361
 Strains of, compared with those on a bridge, 389
- International tonnage, 65
- Isochronism of oscillations of ships in still water, 168
- JET-PROPELLED** vessels :—
 Steaming capabilities of, 590
 Steerage of, 657
- Joëssel rudders, 665
- Jury rudders, 705
- KEELS** :—
 Bilge (*see* Bilge-keels)
 Methods of scarphing in wood ships, 408
 Sliding, to diminish leeway, 507
- Keelsons :—
 Longitudinal strengtheners, 333, 366
- Knees to beams, methods of fitting, 369, 390
- LAP-JOINTS for iron plates and bars, 410
- Lateral resistance. *See* Resistance
- Launches :—
 Of Royal Navy, diagonal planking, 376
 Swift steam, engines and speeds of, 554, 563, 649
- Launching, curves of stability for, 144
 „ severe strains due to accidents in, 323
- Leaks, rate of inflow of water through, 24
- Leaks, usefulness of stoppers, 24
- Lee-boards, use of, in shallow-draught vessels, 507
- Lee-helm, 510
- Leeway :—
 Angle of, 506
 Causes of, in ships sailing on a wind, 508
- Liquid fuel, 568, 570
- Livadia*, behaviour at sea, 248
 „ propulsion of, 645
- Lloyd's register, investigations on masting, 343
- Lloyd's rule for freeboard, 10
- Load-line legislation for merchant ships, 12
- Local strains, 332
- Longitudinal :—
 Bending moments (*also see* Bending), 317
 Bending moments among waves, 312
 „ „ as affected by wave structure, 319
 Bending moments in ships ashore, 322
 „ „ in still water, 299
- Bulkheads (*also see* Bulkheads), 32
- Framing adapted for iron ships, 333
- Oscillations (*also see* Pitchin), 265
- Strength. *See* Strength

- Lucania*, dimensions of, 419
 Lurching, strains consequent upon, 326
- MARINE** boilers, types of, 554
 „ engineering, progress in, 548
- Mast** and guy system, 334
- Masts** :—
 Height of, 528
 Number of, 524
 Proportion of sail carried by each of the, 525
 Rake of, 524
 Stations of, in sailing vessels, 523
 Supported by tripods in turret ships, 344
- Materials** for shipbuilding. *See* Wood, Iron, and Steel
- Megara*, H.M.S., rate of corrosion of skin and loss of, 425
- Merchant ships** :—
 Cellular construction of, 372
 Check upon stowage of cargoes, 170
 Dead-weight tonnage for, 68, 70
 Longitudinal bending moments experienced by, 317
 Longitudinal strains on, 383
 Nominal horse-power for engines of, 539
 Parallelopipedon tonnage for, 71
 Ratios of length to breadth, 419, 462, 477
 Register tonnage for British, 59
 Reserve of buoyancy, 9
 Rules for freeboard, 10, 12
 Rudder areas for, 696
 Sailing capabilities of, 531
 Stability under different conditions, 92, 110, 112
 Steaming capabilities of, 571
 Suez Canal tonnage for, 59, 65
 Water-logged vessels, 22
- Metacentre** for transverse inclinations :—
 Approximate rules for estimating position of, 87, 88
 Change of position due to entry of water into the interior, 112
 Definition of, 83
 Effect of metacentric height upon period of still-water oscillations, 154
- Metacentric** for Transverse inclinations (*continued*) :—
 Height above centre of buoyancy, 86
 „ „ „ gravity, 97, 100, 104
 In a submerged vessel, 95
- Metacentre** for longitudinal inclinations :—
 Height above centre of gravity, in various classes, 119, 120
 Use in estimating change of trim, 122
- Metacentric** diagrams, 89, 93
 „ stability, practical applications of, 102
- Metals**, rates of waste in sea-water, 423
 „ galvanic action on iron, 424
- Miantonomoh*, behaviour in Atlantic, 248
- Minotaur* in collision, 35
- Model** experiments :—
 On efficiency of bilge keels, 177, 255
 On resistances of ships, 481
 On resistance, 479
 On screw-propellers, 616
- Modern** sailing ships, dimensions and proportions of, 530
- Moduli** of elasticity :—
 Method for estimating, 398
 Values for iron and timbers, 399, 400
- Moment** :—
 Longitudinal bending, 300, 304, 317
 Of inertia : explanation of term, 86, 150
 Of inertia, its effect on rolling, 154, 248
 Of inertia, its effect on turning, 672
 Of resistance of girders and ships to bending, 351, 357
 Righting, for transverse inclinations, 81, 230
 To change trim, 122
 Transverse bending, 325, 326, 329
- Muntz** metal for sheathing ships, 432
- NAVAL** brass, 429, 433
- Neutral** axis and neutral surface of beams, 351
- Nickel** steel for bottoms, 435
- Nominal** horse-power, 539
- Normal** horse-power, 541
- Northumberland* in collision, 35

OBSERVATIONS :—

Of dimensions and periods of waves,
210, 213

Of rolling and pitching by :—

Automatic instruments, 285, 292

Batten instruments, 287

Gyroscopic instruments, 283, 285

Pendulums, 277

Photography, 290

Spirit-levels, 281

Tower's steady platform, 294

Wheel-pendulums, 294

Oscillations of ships. *See also* Rolling,
Pitching, and Dipping

PADDLE-WHEELS :—

Disadvantages of, in seagoing
steamers, 573

For manœuvring, 656, 708

High speed obtained in ships driven
by, 574

Practical rules for, 598

Principles of propulsion by, 594

Panting produced by transverse com-
pression on ends of ships, 326

Pendulums :—

Comparison of oscillations with those
of ships, 147

Departure from isochronism with
large angles of swing, 237

Discussion of motion of simple and
bar, 149

Errors of, when used to measure
rolling motion of ships, 279

Use of, for measuring rolling and
pitching, 277, 281, 292

Use of, to illustrate behaviour of
ships at sea, 240

Wheel, 292, 294

Periods of ocean waves :—

Facts respecting, 211, 213, 223

Formulae for, 204

Methods of observing, 207, 210

Periods of oscillation, definition of,
147

Periods of pitching for ships, 265

„ „ rolling for ships in still
water, 154, 165

Pillars, contribution of, to structural
strength, 389

Pitch of screw-propellers, 599

Pitching and 'scending :—

Bertin's automatic records, 269

Causes of, 265

Governing conditions, 267

Influence of form of bow and stern,
and longitudinal distribution of
weights, 270, 271

Of low-ended ships, 271

Periods for, 265

Pitting of iron and steel skins, 426

Planking of wood ships. *See* Skins

Platforms :—

As watertight partitions, 23, 30

Effect on maintenance of stability, 116

Plating of iron ships. *See* Skins

Portage of ships. *See* Tonnage

Progressive trials, 613, 621

Propellers :—

Fundamental principles of, 582

Guide-blades, 582

Mallory, 707

Paddle-wheels, 594

Screw, 599

Under steam and sail, 532

Use of, for manœuvring, 657, 708

Water-jet, 587

Propulsion :—

By sails, 491

By steam power, 532

Strains incidental to, 329, 341

Proportions of yachts, 533

Propulsive coefficients, 542

Pumps cannot cope with a large leak,
24, 594

RACKING strains on ships :—

Incidental to propulsion, 329, 341

Mode of resisting, 374

Produced by rolling, 326

Radius of gyration :—

Defined, 150

Effect upon period of pitching, 265

„ „ rolling, 155

„ turning, 672

Rake of masts, 524

„ sternposts in yachts and ships,
48

Rate of inflow through hole in bottom,
24

Ram attacks :—

Best met by watertight subdivision,
33, 37

- Ram attacks (*continued*):—
 Construction of bows to meet strains of, 339
- Register tonnage:—
 Allowances to steamships, 60
 Compared with displacement (*also see* Tonnage), 70
 Law of 1854 and approximate rules, 56, 59
- Relative strengths and weights of single pieces of wood, iron, and steel, 397
- Reserve of buoyancy for various types of ships, 9
- Reserve of dynamical stability, 188
- Resistance of water (to advance of ships):—
 Augment of resistance due to screw propeller, 546
 Early theories of, 436, 444
 Frictional, direct and eddy-making, 438, 440, 443, 451, 453
 Largely independent of area of mid-ship section, 465, 478
 Stream-line theory of, 445
 Summary of results, 466
 Values of, for certain ships, 471
- Resistance, wave-making, 456
 In a seaway, 490
 To pitching and 'scending, 270
 To planes moving obliquely, 440
 To rolling of ships, 174, 177, 249
 When motion is not uniform, 489
- Resistance, lateral:—
 To ships sailing on a wind, 505
 To turning of ships, 671
- Resistance of air to motion of ships, 487
- Resisted rolling among waves, 249
 " " in still water, 165
- Results of calculation of longitudinal strength, 380
- Revolutions and piston speed, increase in, 552
- Ribs. *See* Framing, Transverse
- Riders, diagonal, for wood and composite ships, 374, 375
- Rigging:—
 Air resistance to, 487
 Spread of, 329
- River steamers, shallow-draught, special features of, 334, 379
- Rolling of ships in still water:—
 Coefficients of extinction, 174
- Rolling of ships in still water (*continued*):—
 Dipping oscillations which accompany, 162
 Effect of changes in stiffness and distribution of weights, 154
 Effect of moment of inertia upon, 155
 " resistance upon, 157
 Extinction of rolling, 167
 Hypothetical case of unresisted rolling, 148
 Instantaneous axis of rotation, 152, 168
 Isochronous rolling, 157
 Oscillations resemble those of pendulums, 147
 Periods of, 154, 169
 Resistance due to keels and bilge keels, surface friction, and surface disturbance, 175, 178
 Resistance due to internal free water, 182, 184
 Resistance in a seaway compared with resistance in still water, 175
 Under action of suddenly applied forces, 186
- Rolling of sailing ships, 258
- Rolling of ships among waves:—
 As influenced by size, 229
 Behaviour of quick-moving ships, 228, 239
 Behaviour of slow-moving ships, 239, 241
 Bertin's formulæ, 253
 Circular ironclads, Russian, 248
 Causes of, 226, 227
 Dangers of synchronism of periods of ships and waves, 235, 242, 254
Devastation, trials of, 231, 243
 Early theories of, 226
 Effect of bilge keels, 254
 Effects of changes in speed and course of ships, 242, 247
Endymion, as obtained by graphic integration, 251, 264
 Governing conditions of, 227
 Importance of ratio of wave period to period of ships, 228, 235, 238
 In a seaway with sails set, 251, 260, 264
Livadia, case of, 248
Miantonomoh, case of, 248

- Rolling of ships among waves (*continued*):—
 Mathematical assumption, 233
 Methods of measuring angles of.
See Observations of Rolling
 Motion of a small raft, 228
 Pendulum illustrations of, 240
 Permanent rolling, 238
 Phases of oscillation, 240
 Records of, 241, 245
 Safety due to increased period as
 angle of swing increases, 237
 Sailing ships, 258
 Sketch of modern theory, 227
 Small rolling of vessels having very
 short periods, 228, 248
 Steadiness secured by bilge keels, 255
 Steadying effect of sails, 264
 " " a confused sea, 234
 Strains on structure due to, 326
 Thornycroft apparatus for steadying
 ships at sea, 184, 258
- Rudders :—
 Auxiliary, 703
 Balanced, 665
 Bow, 699
 Centre of pressure of, 664
 Considerations respecting areas of, 695
 Effective pressures on, 655, 684
 Force required on tiller-end, 663
 Joëssel's, 665
 Lumley's, 699
 Mallory, 707
 Mechanical work done in putting
 over, 667
 Ordinary and balanced, 652
 Rankine's and Schlick's, 698
 Ruthven's counterbalancing weight
 applied to, 669
 Turning effect of, 670
- Rules for freeboard, 10
- Run of ships :—
 Connection between speed of ships
 and length of, 459
- SAGGING :—
 Astride wave hollows, 313
 Causes of, in still water, 300
 Conditions of strain incidental to, 317,
 357
- Sail plans for ships, 329, 504, 527
 Preparation of, 512
- Sailing vessels :—
 Arrangement of sail, 491, 521
 Areas and forms of rudders, 695, 697
 Area of sail in terms of wetted sur-
 face and displacement, 515
 Area of sail in terms of under-deck
 tonnage, 517
 Balance of sail, 520
 Base of sail, 523
 Centre of effort, position of, in, 521,
 526, 528
 Determination of aggregate sail area,
 516, 517
 Forms and proportions of, 531, 532
 Heel of, under canvas, 81, 187, 260,
 329, 504, 527
 High speeds of modern, 531
 Longitudinal distribution of sail, 520
 Plain sail for various styles of rig, 513,
 517
 Propelling effect of wind on sails, 504
 Range of stability necessary for
 safety, 263
 Register tonnage of, 57, 60
 Steadying action of sails, 264
 Stiffness, or sail-carrying power, 528
 Strains due to propulsion, 329
 Under action of squalls of wind, 188,
 264
 Vertical distribution of sail, 526
 With more than three masts, 524
- Scarphs of various pieces in wood
 ships, 408
- 'Scending. *See* Pitching
- Schlick's, Herr, experiments on divided
 rudders, 657
- Sea trials of speed, 612
- Shoal water, effect of, on resistance,
 466, 469
- Schooners :—
 Centre of effort of, 522
 Plain sail of, 513, 517
 Stations of masts and base of sail, 523
- Screw-propellers :—
 Augment of resistance due to, 546
 Conditions for maximum efficiency,
 601, 608
 Diameter, pitch, disc-area, and slip,
 599
 Experiments to determine best pro-
 pellers for *Iris*, 615
 Ditto for torpedo-boats, 613

- Screw-propellers (*continued*):—
 Effect of propeller race upon steerage, 658
 Large diameters not always advantageous, 608
 Mallory, 707
 Manœuvring powers of single and twin, 657, 658
 Motion of particles in race, 606
 Necessity for free flow of water to, 605
 Principles of action, 600
 Use of twin and multiple, 579
 Virtual increase of resistance produced by, 546
 Screws, steering, mode of fitting, 653
 Screw turbine propeller, 581
 Sea water, weight of, 7
 Shallow-draught vessels:—
 Difficulty of steering, 674
 Special structural arrangements, 334, 379
 Shearing strains on ships unimportant, 299
 Sheer strakes, useful as longitudinal strengtheners, 365
 Shift of butts for planking and ribs of wood ships, 349, 363
 Shifting cargoes, effect on stability, 110, 112
 Ship design as regards forms and resistances, 474
 Ship rig:—
 Base of sail, 523
 Plain sail of, 513
 Position of centre of effort, 522
 Stations of masts, 523
 Shoal water:—
 Effect on speed, 466, 469
 „ resistance, 466, 469
 „ steering, 674
 Sinkage due to bilging, 26
 Skins of ships:—
 Arrangements in composite ships, 375
 „ iron ships, 376
 „ wood ships, 349, 363
 Essential features of all classes, 346
 Resistance to penetration of wood and iron, 346
 Strains due to water pressure between frames, 335
 “Slackness” of sailing ships, 510
 Slip of paddle-wheels, 595
 Slip of screw propellers, 600
 Spar-deck vessels, 15
 Speeds:—
 Lengths of entrance and run appropriate to, 459
 Limited by commercial considerations, 474
 Of merchant steamers, 646, 649
 Of sailing ships, 531
 Of ships, recent advances in, 470
 Of unarmoured warships and iron-clads, 641, 649
 Spirit-levels not trustworthy instruments for measuring rolling, 281
 Stability, statical:—
 Affected by shifting cargoes and free water in hold, 110, 112
 Amongst waves reckoned from normal to effective slope, 233
 Atwood's formula for, 127
 Construction and use of curves of, 127
 Definition of, 82
 Effect of adding or removing weights, 117
 Effect of heaving motion on, 203, 260
 Less for mastless ships than for rigged ships, 188
 Longitudinal, 121
 Metacentric method of estimating, 84, 102
 Of cigar and cylindrical forms, 94
 Of ships partially water-borne, 124
 Of ships when launched, 141
 Of submarine vessels, 95
 Range of, required for safety, 263
 Transverse, 83
 With liquid cargoes, 111
 „ ship bilged, 115
 Stability, dynamical:—
 Definition of, 158
 Effect of suddenly applied forces with reference to, 186
 Mode of estimating, 161
 Moseley's formula for, 160
 Reserve of, 188
 Steadiness:—
 Assisted by deep-bilged-keels, 254
 „ sails, 264
 Definition of, 84
 Increased by lenthening still-water period of ships, 155, 243
 Lessens transverse straining, 326

- Steam blast, 559
 Steamships :—
 Economical propulsion of, 478, 637, 641
 Engine power and speeds of various classes, 642, 649
 Estimates of speed and engine-power, 625, 635
 Measures of engine-power, 536, 541
 Ordinary conditions of design, 474, 535
 Progress in construction of, 418, 648
 Register tonnage of, 59
 Steerage of, 652
 Steam pressure, increase in, 548
 " propulsion, 534
 Steam-steering gear, advantage of, 669
 Steel as a material for ship-building :—
 Features in which it is superior to iron, 415
 Mild steel used in the Royal Navy, 417
 Precautions against buckling and corrosion, 402
 Savings, due to use of, 415
 Steerage of sailing and steam ships, 651
 Steering blades, use of, 705
 " by propellers, 658
 Steering gear :—
 Manual, 668
 Steam and hydraulic, 669
 Steering screws, proposed use of, 702
 Steering trials :—
 Axis of rotation, 675
 Deductions from trial of steamers, 687
 Drift angle, 681
 Initial motions of ships, 675
 Path described by the ship, 679
 " Pivoting point," 681
 Preliminary or constructor's trials, 689
 Slewing when not under way, 658
 " Tactical diameter " and " advance " of ship, 688
 Steeve of bowsprits, 524
 Stern :—
 Effect of length and form upon resistance, 445, 453, 459
 Strengthenings of, in wood screw steamers, 342
 Sternway, steerage of ships having, 659
 Stiffness :—
 Definition of, 84
 Effect of form and stowage of ships upon, 87, 92
 Stiffness (*continued*) :—
 Effect of variations in, upon periods of oscillation, 154
 Measured by metacentric height, 83
 Measure of power to carry sail, 528
 Stowage of weights or cargo :—
 Effect upon stability, 92
 " longitudinal bending moments, 300, 303
 Proposal to check by rolling experiments, 170
 Strains experienced by ships :—
 Among waves, 313
 Classification of principal, 299
 Due to collision, 337
 " grounding, 335
 " propulsion, 328, 341
 Local, 299
 Longitudinal bending :—
 Among waves, 313
 In still water, 299, 317
 " " when light, 310
 Measures of, in mercantile and ironclad ships, 317, 383
 When vessel is heeled over, 321
 Racking or shearing, 327
 Transverse :—
 Ship aground, 324
 " afloat, 325
 " rolling in a seaway, 326
 Values (numerical) of bending, 317
 Stream-line theory of resistance, 445
 Strength of shipbuilding materials. *See* Wood, Iron, and Steel
 Strength of ships :—
 As influenced by proportions of length, breadth, and depth, 356
 Against local strains, 328, 332
 " longitudinal bending, 317
 " transverse strains, 385
 Compared with that of a bridge, 384
 Considerations governing vertical and longitudinal distribution of the material, 360
 General remarks on, 345
 Sometimes reduced by increasing the depth, 358
 Stringers :—
 In hold, uses of, 364
 On decks, valuable strengthenings, 356, 364

Subdivision, watertight. *See* Watertight
 Subdivision
 Submarine vessels, 19
 Principles of construction, 19
 Resistance of, 438, 447
 Stability of, 95
 Suez Canal, tonnage for dues, 59, 65
 Surface vessels, 19
 Systems of watertight subdivision, 25

TABLES :—

Angles of heel as measured correctly,
 and as given by pendulum clino-
 meters, 281, 282
 Behaviour of ships at sea, observa-
 tions of, 241, 244, 246
 Beaufoy's experiments on oblique re-
 sistances, 440
 Calculation for centre of effort of sail,
 521
 Calculation for change of trim, 124
 Circular ship compared with *Devasta-
 tion*, 645
 Coal consumption, weights, etc., of
 marine engines of different types,
 564, 567
 Coefficient :—
 For tons per inch, 7
 For moment of inertia of water-
 plane, 87, 119
 For extinction, 175, 176
 Of fineness, for displacement, 3
 Comparative weight of iron and steel
 ships, 415
 Corrosion and waste of metals in sea
 water, 424
 Equivalent girder, calculation of, 355,
 356
 Experimental determination of pres-
 sure of wind, 493
 Froude's experiments on surface
 friction, 443
 Galvanic action, 424
Greyhound, resistances at given speeds,
 476
Hercules compared with *Greyhound*,
 635
 I.H.P. in typical war-ships, 649
 Illustrating economy of propulsion in
 large steamers, 649
 Influence of bilge-keels on range and
 period of rolling, 177, 255

Tables (*continued*) :—

Influence of freeboard and beam on
 range of stability, 129
 Influence of helm-angle in circle
 turning, 692
 Lengths, speeds, periods, heights, etc.,
 of ocean waves, 214, 216, 222, 224
Livadia compared with other ships,
 646
 Longitudinal bending moments, 317
Merkara compared with model B,
 465
Merkara resistances at given speeds,
 476
 Metacentric heights of merchant
 steamships, 100
 Metacentric heights of sailing ships,
 105
 Metacentric heights of war-ships, 97
 Modulus of elasticity of iron and
 timber, 399
 Particulars :—
 Of *Hercules* and long type of iron-
 clad, 643
 Of indicated horse-power and speeds
 for various vessels, 649
 Of stability for *Captain* and *Mon-
 arch*, 188
 Pendulum errors in rolling, 281, 282
 Period of rolling as affected by arc of
 rolling, 237
 Period of waves, trochoidal, 205
 Principal dimensions, etc. :—
 Of merchant steamers, and results
 of inclining experiments, 100
 Of sailing vessels and yachts, 104
 Of war-ships, 104, 420, 642, 649
 Reduction of speed on circle, 671
 Reserve of stability *Monarch*, and
Captain, 188
 Resistances :—
 Of *Greyhound* and *Merkara*, 476
 Of keels, bilge keels, skin, and
 wave-making, 176, 456
 Sail, plain, with various styles of rig,
 513, 517
 Stability of *Inflexible*, 134
 „ „ ships at various angles
 (curves of stability), 133, 135, 138,
 142
 Stations of masts, base of sail, etc.,
 523

- Tables, (*continued*):—
- Steadying action of water on armour deck of *Inflexible*, 186
 - Strengths and weights of iron and shipbuilding timbers, 399, 404
 - Tensile strains in merchant vessels, 383
 - Tensile strengths of materials, 399, 404
 - Thermopylae* compared with *Pique*, 531
 - Tonnage register of merchant steamers, 57
 - Turning trials of *Thunderer*, 679
 - " " *Warrior* and *Hercules*, 690
 - Watertight compartment of ironclads, 33
 - Weights of hull and carrying power, 417, 418
 - Tensile strengths of wood and iron, 399, 400
 - Thames rule for yacht tonnage, 75
 - Theories of the screw-propeller, 605
 - Thrust, indicated, 631
 - Thunderer*, as refitted:—
 - Voyage to Madeira and back, 570
 - Timbers, shipbuilding:—
 - Compressive strengths, 399
 - Moduli of elasticity, 399
 - Tensile strengths and weights (*see also Wood*), 399
 - Tonnage deck, 54
 - " of ships, 45
 - Act of 1889, 53, 55, 58, 60, 64
 - Admiralty commissions of, 1821, 1883, 50
 - Alternative systems of tonnage, 67
 - Awning-decked ships, 55
 - Builders' old measurement, 47
 - Breadth for tonnage, 48
 - Cellular-bottomed ships, how measured, 55
 - Commission of 1849, 52
 - " " 1881, 53, 55
 - " " Danube, 63
 - " " International, at Constantinople, in 1873, 65
 - Countries using Moorsom system, 67
 - Danube rule, 63
 - Dead-weight tonnage, 68, 70
 - " " cargo a ship can carry, 69
- Tonnage of ships (*continued*):—
- Deck-spaces, allowances for closed-in, 58
 - Deductions for measuring, 60
 - Displacement tonnage, 70, 73
 - Earliest English law relating to "keels" or coal barges, 47
 - Early laws, 47
 - Freight tonnage, 72
 - German rule, 63
 - International tonnage, 65
 - Legal tonnage of coal vessels, 46
 - Legislation during 1821, 50, 53
 - Length of keel for tonnage, 48
 - Merchant Shipping Act of 1854, 52
 - Moorsom system, 52
 - New measurement of, 1836, 51
 - Origin of B.O.M. rule, 49
 - Parallelopipedon tonnage, 71
 - Parliamentary "tons weight of hull," 74
 - Register tonnage, 59
 - Approximate rules for, 56, 57
 - Gross, 59, 66
 - Nett, 59, 66
 - Of sailing ships, 60
 - Of tugs, 66
 - Suez Canal rules, 59, 65
 - War-ship tonnage, 73
 - Yacht tonnage, 75
 - Tons per inch immersion, 7
 - Torpedo attacks, watertight subdivision as a precaution against, 33
 - Torpedo-boats, 649
 - Transverse:—
 - Bulkheads. *See* Bulkheads
 - Oscillations. *See* Rolling
 - Stability at large angles of inclination, 125
 - Strains on ships afloat on still water, 325
 - " " aground, 324
 - " " in a seaway, 326
 - " " under sail, 329
 - Strength, 385
 - Trim of ships:—
 - Affected by entry of water into hold, 27
 - Change of, in ships under sail, 506
 - Definition of, 5
 - Estimates for changes of, 121, 124
 - How measured, 5

- Triple-expansive engines, 550
 Advantages of, in cargo vessels, 571
 " " in the older war-vessels, 569
 Weight of, 564
 Triple screws, 579
 Tripod supports to masts, 344
 Trochoidal theory for waves. *See* Waves
 Turbine propellers, 581
 Twin screws :—
 First used in shallow-draught vessels, 575
 Good performances of, in deep-draught ships, 576, 642
 Steering power of, 710. *See also* Propellers and Screw Propellers

 UNARMOURED war-ships :—
 Sailing capabilities of, 530
 Speeds and dimensions of, 649
 Steaming capabilities of, 564, 649
 Structural arrangements of, 339, 363, 369
 Use of iron hulls for, 420
 Weight of hulls for, 418
 Useful displacement, 2, 478
 " work of marine engines, 537
 Utilization of ocean-wave power, 225

VANGUARD, loss of, 35
 Vessel with bottom bilged, 23
 Vibration of steamships, 330

 WAKE of ships, characteristics of the, 454
 Wake percentage, 456
 War-ships (*see* Ironclads and Unarmoured Ships) tonnage, 72
 Waste work and augmentation of resistance due to action of propellers, 546
 Water :—
 Draught of. *See* Draught of Water
 Not a perfect fluid, 437
 Velocity of inflow into damaged ship, 24
 Weights per cubic foot of sea and river, 7
 Water ballast :—
 Effect upon stability, 117
 Methods of carrying, 32, 111, 369, 372
 Water chambers, 182, 257

 Water-jet propellers, 587
 Water-logged ships, 22
 Watertight subdivision :—
 By decks and platforms, 30
 By longitudinal bulkheads, 29
 By transverse bulkheads, 26, 27
 In merchant ships, 39
 Maintenance of stability by, 111
 More important than pumping power, 594
 Of vessels on Admiralty list, 39
 Of war-ships, 31, 33, 369
 Principles of, 25
 Wave-line theory of resistance, 457
 Wave-making resistance of water, 456
 Defined, 456
 Expenditure of force on, 466
 Governing conditions of, 459, 462
 Importance of, at certain speeds, 464, 481
 To rolling of ships, 177
 Waves, deep sea :—
 Advance of form and motion of particles, 196
 Construction of profiles, 194
 Dimensions corresponding to given forces of wind, 222
 Effective slope of, 229
 Exaggeration of heights, 212
 Fluid pressures in, 198
 Heaving motion produced by, 203, 260
 Influence of ratio of wave period to still-water period of ship, 235
 Internal structure, 198
 Longitudinal strains of ships amongst, 313, 317
 Maximum slopes, 203
 Methods of observing dimensions, 207, 210
 Oscillations of ships amongst. *See* Pitching and Rolling
 Ratios of heights to lengths, 214, 223
 Speed of wave compared with speed of wind, 222
 Summary of observed dimensions, 211
 Superposition of series, 217
 Theoretical formulæ for, 204
 Transverse strains of ships amongst, 385
 Utilization of power, 225
 Viscosity of, 205

- Weights, per cubic foot :—
 Of iron, 400
 Of principal shipbuilding timbers, 399
 Of sea and river water, 7
- Weights of hulls in various classes of ships, 415, 417, 418
- Weights per indicated horse-power for various types of marine engines, 564
- Wind on sails, propulsive effect of, 503
- Wind pressure, laws of, 491
- Wind pressures on oblique plates, 498
- Winds :—
 Apparent direction of, 503
 Condition of ships sailing on a, 505
 Connection between force of wind and size of wave, 222
 Classification of, 502
 Distribution of pressure of, over area, 496
 Normal pressure as affected by size, 495
 Oblique action on sails, 498
 Outstripped by ice yachts, 509
- Wing passage bulkheads, 35
- Wood as a material for shipbuilding :—
 Causes of decay in, 420
 Compared with iron, 406
 Moduli of elasticity, 399
 Resistance of combination to tensile and compressive strains, 409
 Resistance to bending strains, 404
 „ „ perforation, 336
 Tensile and compressive strengths of, 399
- Wood ships :—
 Average durability of, 419
 Construction of ram bows, 338
- Wood ships (*continued*) :—
 Features in which inferior to iron and steel, 420
 Metal sheathing on bottoms, 428
 Methods of framing, 363
 Rapid decay of many, 420
 Skin planking of, 349, 363
 Stern strengthenings of screw steamers, 342
 Strengths of bottoms, 336
- Work, mechanical :—
 Definition of, 158
 Done in inclining ships, 160
 „ putting rudder over, 667
 Useful, of marine engines, 537
- YACHTS :—
 Displacement tonnage, 77
 Forms and proportions of racing, 533
 Her Majesty's, special construction of, 376
 Her Majesty's, speed of, 574, 646
 Ice, speed of, 509
 Power to carry sail, 529
 Sail spread of, 519
 Time allowance on racing by New York rule, 78
 Tonnage measurements :—
 By Corinthian rule, 76
 By sail-spread rule, 77
 By Thames rule, 75
- Yards, bracing of, when sailing on a wind, 510
- Yawing, mode of measuring, 285
- Yawls, plain sail of, 513
- Zinc sheathing for bottoms of wood and iron ships, 430, 434
 Zinc protectors to copper sheathing, 429

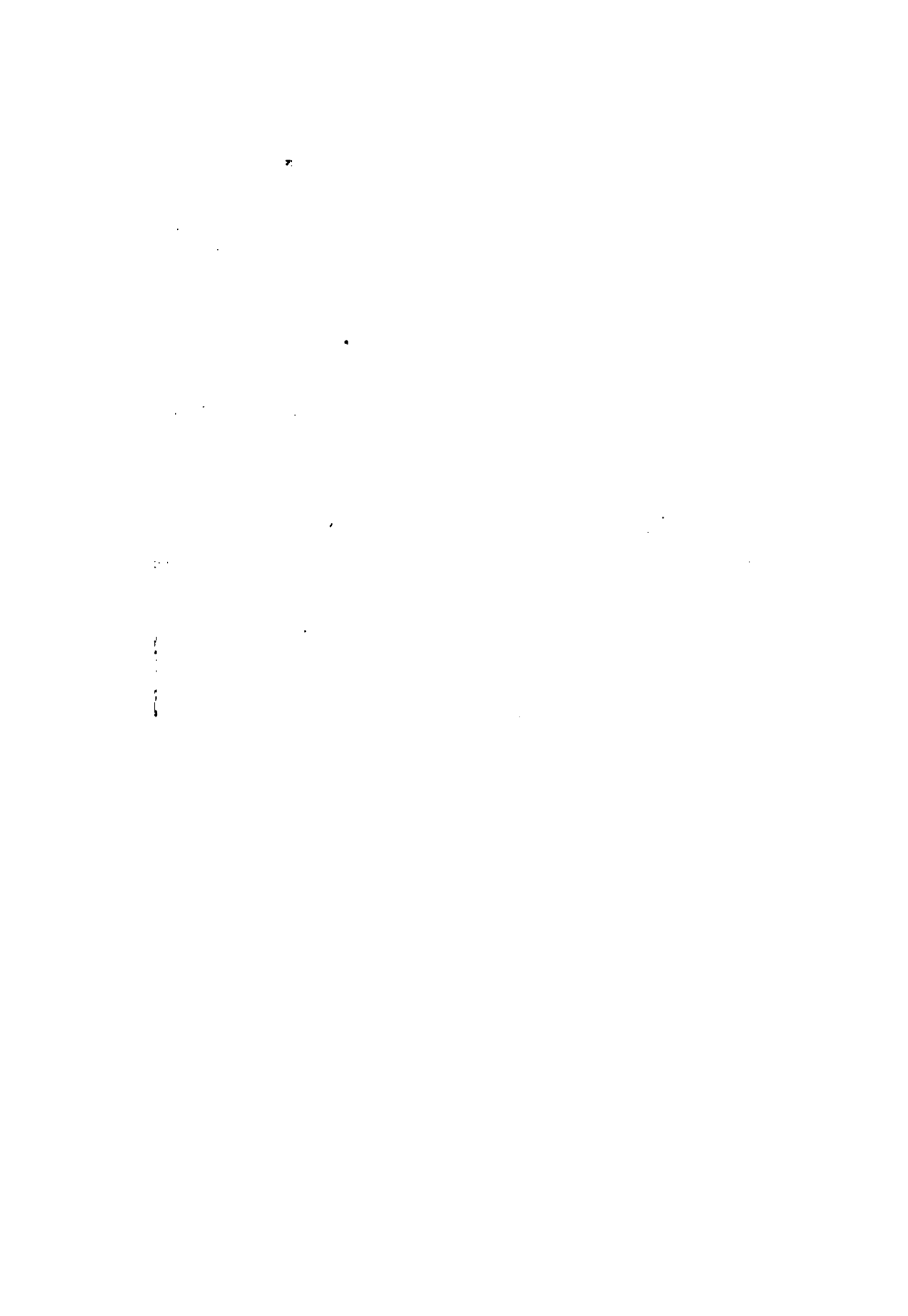

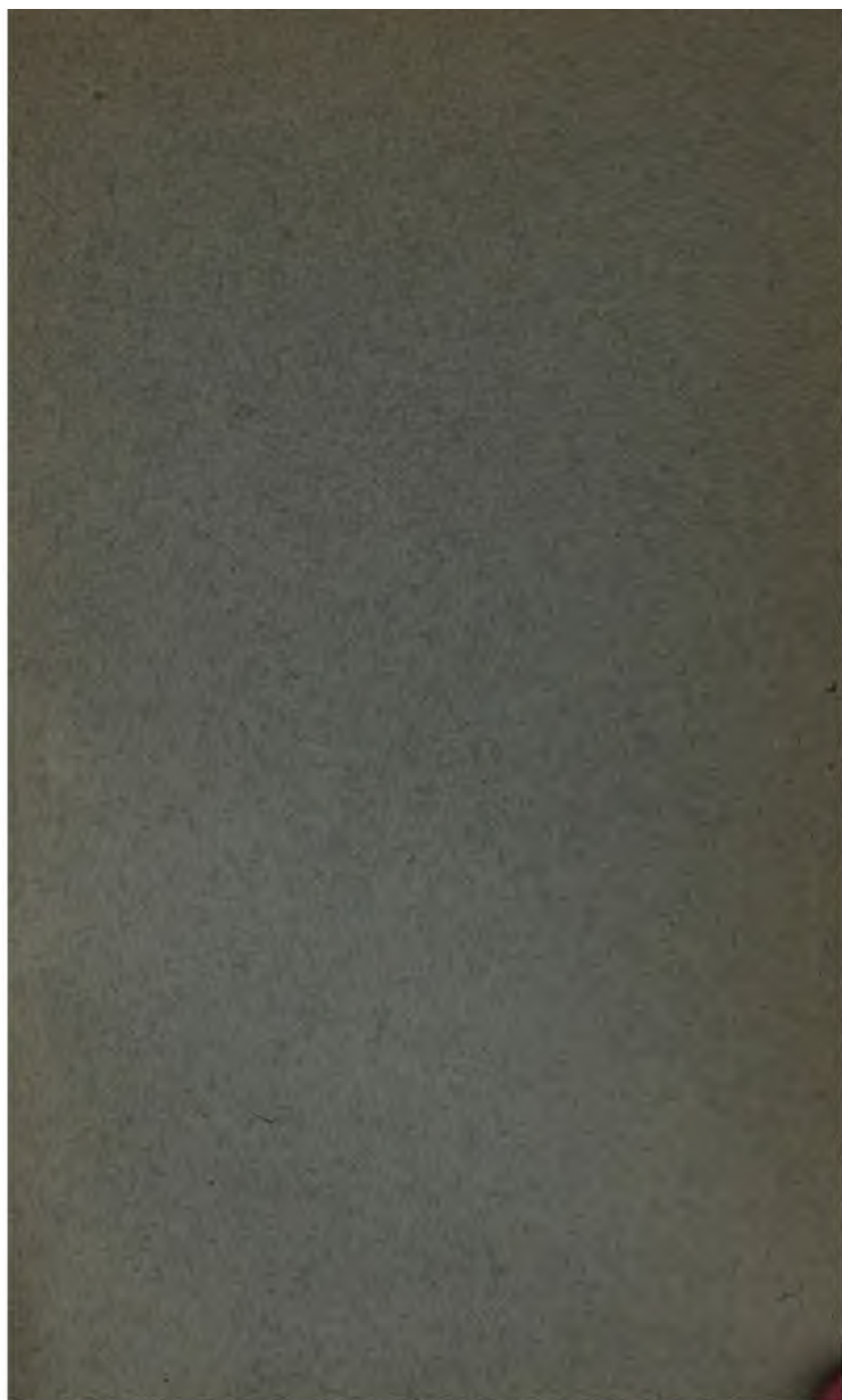



UNIVERSITY OF MICHIGAN

3 9015 00984 3536

B 778,558



